

# ATLAS

11. INTERNATIONAL CONGRESS ON ADVANCED  
SCIENTIFIC STUDIES AND INTERDISCIPLINARY  
RESEARCH

January 16-18, 2024 / Marrakesh, MOROCCO



## PROCEEDINGS BOOK

### EDITORS

Prof. Atiya ABUHARRIS

Merve KIDIRYÜZ

ISBN: 978-1-955094-94-8

Liberty Academic Publishers- 2024©

# ATLAS

## 11th INTERNATIONAL SOCIAL SCIENCES CONGRESS

January 16-18, 2024



# PROCEEDINGS BOOK

**EDITORS:**  
**Prof. Atiya ABUHARRIS**  
**Merve KIDIRYUZ**

Copyright © Liberty

05.02.2024

by Liberty Academic Publishers  
New York, USA

**ALL RIGHTS RESERVED NO PART OF THIS BOOK MAY BE REPRODUCED IN ANY FORM, BY  
PHOTOCOPYING OR BY ANY ELECTRONIC OR MECHANICAL MEANS, INCLUDING  
INFORMATION STORAGE OR RETRIEVAL SYSTEMS, WITHOUT PERMISSION IN WRITING  
FROM BOTH THE COPYRIGHT OWNER AND THE PUBLISHER OF THIS BOOK.**

© Liberty Academic Publishers 2024

The digital PDF version of this title is available Open Access and distributed under the terms of the Creative Commons Attribution-Non Commercial 4.0 license (<http://creativecommons.org/licenses/by-nc/4.0/>) which permits adaptation, alteration, reproduction and distribution for noncommercial use, without further permission provided the original work is attributed.

The derivative works do not need to be licensed on the same terms.

ISBN: 978-1-955094-94-8

## CONGRESS ID

## CONGRESS TITLE

ATLAS 11th INTERNATIONAL SOCIAL SCIENCES CONGRESS

## DATE AND PLACE

January 16-18, 2024/ Marrakesh, MOROCCO

## ORGANIZATION

ATLAS Journal

American University of Libya

## ORGANIZING COMMITTEE

Prof. Elham ALEZABY

Prof. Dr. Natalia LATIGINA

Assoc. Prof. Dr. Osman Kubilay GÜL

Dr. Ahmed Abdelwahab Abdelsalam IBRAHIM

Fathi NASSER

Assoc. Prof. Dr. Faruk MIKE

Ali NASEER

Miss Hajer NURI

Congress General Coordinator

Merve KIDIRYUZ

## PARTICIPANTS COUNTRY (18 country)

Türkiye, Azerbaijan, Algeria, Albania, Pakistan, Serbia, Morocco, Indonesia, Nigeria, United Arab Emirates, Benin, Ethiopia, India, Romania, Moldova, West Africa, Kazakhstan, Libya.

**Total Accepted Article: 64**

**Total Rejected Papers: 13**

**Accepted Article (Turkey): 26**

**Accepted Article (Other Countries):38**

Prof. Dr. Anderi JEAN  
*Grolium University of Romania*

Prof. Dr. Salih ÖZTÜRK  
*Tekirdağ Namık Kemal University*

Assoc. Prof. Dr. Gönül SAMEDOVA  
*Azerbaijan State Pedagogy University*

Assoc. Prof. Ruslan ABDULLAYEV  
*Azerbaijan National Academy of Sciences*

Dr. Usman Ghani, PhD  
*Institute of Management Sciences Peshawar, Pakistan*

Dr. Katarzyna Czech, PhD  
*Warsaw University of Life Sciences, Poland*

Dr. Yuriy Danko, PhD  
*Sumy National Agrarian University, Ukraine*

Dr. Olena Melnyk, PhD  
*Sumy National Agrarian University, Ukraine*

Dr. Michal Wojtaszek, PhD  
*Warsaw University of Life Sciences, Poland*

Dr. Maral Jamalova, PhD  
*Szent Istvan University, Hungary*

Dr. Nicholas Imbeah, PhD  
*Takoradi Technical University, Ghana*

Dr. Harshavardhan Reddy Kummitha, PhD  
*Budapest Business School, Hungary*

Dr. Banu KOZ  
*Karamanoglu Mehmet Bey University*



# ATLAS 11<sup>th</sup>

## INTERNATIONAL CONGRESS ON ADVANCED SCIENTIFIC STUDIES AND INTERDISCIPLINARY RESEARCH

January 16-18, 2024/ Marrakesh, MOROCCO

## CONGRESS PROGRAM

Meeting ID: 858 1117 0419  
Passcode: 171717

**Participant Countries: (18)**

Türkiye, Azerbaijan, Algeria, Albania, Pakistan, Serbia, Morocco, Indonesia, Nigeria, United Arab Emirates, Benin, Ethiopia, India, Romania, Moldova, West Africa, Kazakhstan, Libya.

## Important, Please Read Carefully

- To be able to attend a meeting online, login via <https://zoom.us/join> site, enter ID "Meeting ID or Personal Link Name" and solidify the session.
- The Zoom application is free and no need to create an account.
- The Zoom application can be used without registration.
- The application works on tablets, phones and PCs.
- The participant must be connected to the session 5 minutes before the presentation time.
- All congress participants can connect live and listen to all sessions.
- Moderator is responsible for the presentation and scientific discussion (question-answer) section of the session.

## Points to Take into Consideration - TECHNICAL INFORMATION

- Make sure your computer has a microphone and is working.
- You should be able to use screen sharing feature in Zoom.
- Attendance certificates will be sent to you as pdf at the end of the congress.
- Moderator is responsible for the presentation and scientific discussion (question-answer) section of the session.

**Before you login to Zoom please indicate your name surname and hall number,  
exp. Hall-1, Merve KIDIRYUZ**

## Önemli, Dikkatle Okuyunuz Lütfen

- Kongremizde Yazım Kurallarına uygun gönderilmiş ve bilim kurulundan geçen bildirimler için online (video konferans sistemi üzerinden) sunum imkanı sağlanmıştır.
- Online sunum yapabilmek için <https://zoom.us/join> sitesi üzerinden giriş yaparak "Meeting ID or Personal Link Name" yerine ID numarasını girerek oturuma katılabiliyorsunuz.
- Zoom uygulaması ücretsizdir ve hesap oluşturmaya gerek yoktur.
- Zoom uygulaması kaydolmadan kullanılabilir.
- Uygulama tablet, telefon ve PC'lerde çalışıyor.
- Her oturumdaki sunucular, sunum saatinden 5 dk öncesinde oturuma bağlanmış olmaları gerekmektedir.
- Tüm kongre katılımcıları canlı bağlanarak tüm oturumları dinleyebilir.
- Moderatör - oturumdaki sunum ve bilimsel tartışma (soru-cevap) kısmından sorumludur.

## Dikkat Edilmesi Gerekenler - TEKNİK BİLGİLER

- Bilgisayarınızda mikrofon olduğuna ve çalıştığına emin olun.
- Zoom'da ekran paylaşma özelliğini kullanabilmelisiniz.
- Kabul edilen bildiri sahiplerinin mail adreslerine Zoom uygulamasında oluşturduğumuz oturuma ait ID numarası gönderilecektir.
- Katılım belgeleri kongre sonunda tarafınıza pdf olarak gönderilecektir.
- Kongre programında yer ve saat değişikliği gibi talepler dikkate alınmayacaktır.
- 

**Zoom'a giriş yaparken önce lütfen adınızı, soyadınızı ve SALON numaranızı yazınız  
Örnek: Salon-1, Merve KIDIRYUZ**

*(All speakers required to be connected to the session 15 min before the session starts)  
Moderator is responsible for ensuring the smooth running of the presentation, managing the group discussion and dynamics.*

17.01.2024 | HALL-1



Ankara Local Time: 13<sup>00</sup>-15<sup>00</sup>

HEAD OF SESSION: Assoc. Prof. Dr. Zehra GÖZÜTOK TAMDOĞAN

AUTHORS	AFFILIATION	TOPIC TITLE
Dr. Mustafa KOÇ	<i>Istanbul Technical University (Türkiye)</i>	PICKPOCKETING IN ISTANBUL (1934-1935)
Yusuf SAYAR	<i>Kapadokya University (Türkiye)</i>	TÜRKİYE-USA RELATIONS BETWEEN 1960-1970
Tuğba ÖNEY	<i>Bursa Technical University (Türkiye)</i>	OTTOMAN FOUNDATIONS AND THEIR SOCIAL FUNCTIONALITY: THE CASE OF BURSA PROVINCE
Fatma ERASLAN Mustafa UYANIK	<i>Kırşehir Ahi Evran University (Türkiye)</i>	MAKDİSİ IN THE CONTEXT OF ITS CONTRIBUTION TO HISTORICAL GEOGRAPHY
Dr. Ahmet ÖZBAY Melis KARAKAŞ	<i>Ministry of Education (Türkiye) İstanbul Aydın University (Türkiye)</i>	NARCISSISTIC PERSONALITY DISORDER AND ITS TREATMENTS WITHIN THE FRAMEWORK OF PSYCHOTHERAPY APPROACHS
Assist. Prof. Dr. Muhammet TORTUMLU Lect. Dr. Kıvanç UZUN	<i>Burdur Mehmet Akif Ersoy University (Türkiye)</i>	THE PREDICTIVE ROLE OF YOUNG ADULTS' CAREER PLANNING SKILLS ON THEIR CAREER OPTIMISM AND EMPLOYMENT HOPE
Assoc. Prof. Dr. Zehra GOZUTOK TAMDOĞAN	<i>Tekirdağ Namik Kemal University (Türkiye)</i>	TUNUSIAN PILGRIM GUEST of ISTANBUL in 1882: MUHAMMAD AL-SENUSI
Gülçin SAĞIR KESKİN	<i>Ankara Univeristy (Türkiye)</i>	DISCUSING THE CONCEPTS OF SOVEREIGNTY AND STATE OF EMERGENCY THROUGH CARL SCHMITT
Dr. Ceyhun ŞAKİROĞLU	<i>Azerbaijan National Academy of Sciences (Azerbaijan)</i>	TOLERANCE IN RELATIONS BETWEEN CIVILIZATIONS IN THE AGE OF GLOBALIZATION PROBLEMS OF THE FORMATION AND DEVELOPMENT OF THE ENVIRONMENT



17.01.2024 | HALL-2



Ankara Local Time: 13<sup>00</sup>-15<sup>00</sup>

HEAD OF SESSION: Assist. Prof. Dr. Mehmet Akif HAFIZOĞLU

AUTHORS	AFFILIATION	TOPIC TITLE
Res. Assist. Merve CEYHAN Assist. Prof. Dr. Uğur GÜREL	<i>Eskişehir Osmangazi University (Türkiye)</i>	RADIOMIC FEATURE EXTRACTION IN CANCER- SPECIFIC PREDICTIVE MODELING
Assist. Prof. Dr. Uğur GÜREL Res. Assist. Merve CEYHAN	<i>Eskişehir Osmangazi University (Türkiye)</i>	EARTQUAKE ASSISTANCE PLATFORM
Assoc. Prof. Dr. Mustafa BUGDAY Abakar İBRAHİM MAHAMAT Yacoub NAGI MOHAMED Adam HISSEIENE MAHAMAT	<i>Karabük University (Türkiye)</i>	HEAT RECOVERY VENTILATION
Kerim İŞLER Eser Burak GEZEN Prof. Dr. Mete KALYONCU	<i>Buzçelik Thermic Equipments Industry (Türkiye) Buzçelik Thermic Equipments Industry (Türkiye) Konya Technical Univeristy (Türkiye)</i>	INVESTIGATION OF THE EFFECTS OF DIFFERENT REFRIGERANTS ON THE CAPACITY OF A FINNED- TUBE CONDENSER USING UNILAB COILS SOFTWARE
Assist. Prof. Dr. Mehmet Akif HAFIZOĞLU	<i>Dicle University (Türkiye)</i>	ADHESIVE WEAR INVESTIGATION OF GLASS FIBER MATERIALS
Res. Assist. Dr. Mustafa Eren RIZELI Assist. Prof. Dr. Mehmet Ali ERTÜRK Res. Assist. Dr. Abdullah SAR	<i>Fırat University (Türkiye)</i>	PETROGRAPHY OF MAFIC MICROGRANULAR ENCLAVES IN LATE CRETACEOUS MAGMATIC ROCKS LOCATED IN THE NORTHEAST OF ELAZIĞ (SE TÜRKİYE): PRELIMINARY STUDY
Dr. Bahar YAKUT ÖZEK	<i>Ministry of Education (Türkiye)</i>	PHILOSOPHICAL THINKING IN EARLY CHILDHOOD EDUCATION: DEVELOPING CRITICAL THINKING SKILLS WITH P4C
Dr. Bahar YAKUT ÖZEK	<i>Ministry of Education (Türkiye)</i>	DEVELOPMENT OF CRITICAL THINKING SKILLS IN PRESCHOOL PERIOD
Res. Assist. Dr. Meryem KONCAK DOĞRUER	<i>Istanbul University (Türkiye)</i>	SPATIAL DISTRIBUTION OF POPULATION IN DALAMAN BASIN (1965-2022)

17.01.2024 | HALL-3



Ankara Local Time: 13<sup>00</sup>-15<sup>00</sup>

HEAD OF SESSION: Assoc. Prof. Dr. Irmak KARADUMAN ER

AUTHORS	AFFILIATION	TOPIC TITLE
Lect. Dr. Sevinç TAY Prof. Dr. Murat YILMAZTEKİN	Malatya Turgut Ozal University (Türkiye) İnönü University (Türkiye)	ENCAPSULATION OF GREEN TEA EXTRACT BY ELECTROSTATIC EXTRUSION TECHNIQUE
Assist. Prof. Dr. Tülay GURSOY Assoc. Prof. Dr. Nurhayat ATASOY	Yüzüncü Yıl University (Türkiye)	HEAVY METAL CONTENT OF THE LINDEN PLANT GROWED IN VAN/TURKEY PROVINCE
Assist. Prof. Dr. Tülay GURSOY Assoc. Prof. Dr. Nurhayat ATASOY	Yüzüncü Yıl University (Türkiye)	HEAVY METAL CONTENT OF THE WATERCANE PLANT GROWED IN VAN/TURKEY PROVINCE
Assist. Prof. Dr. Sezen TEKİN Lect. Tuğba ÇORLU Assoc. Prof. Dr. Irmak KARADUMAN ER Prof. Dr. Selim ACAR	Çankırı Karatekin University (Türkiye) Süleyman Demirel University (Türkiye) Çankırı Karatekin University (Türkiye) Gazi University (Türkiye)	INVESTIGATION OF OPTICAL AND PHOTODIODE PROPERTIES OF La-DOPED ZnNiO THIN FILMS
Dilber ÇAGLAR	Dimes Food Ind. and Inc (Türkiye)	FOODS WITH POSTBIOTIC AND SYMBIOTIC PROPERTIES
Beyza DURUCU	Dimes Food Ind. and Inc (Türkiye)	PACKAGING COLLABORATIONS WITH ARTIFICIAL INTELLIGENCE
Pelin YAZICI KARAYAĞIZ	Dimes Food Ind. and Inc (Türkiye)	ALTERNATIVE METHODS AND TECHNOLOGIES TO THE USE OF SO <sub>2</sub> IN WINE PRODUCTION
Res. Assist. Kübra İNÇ Prof. Dr. H. Soner ALTUNDOĞAN	Fırat University (Türkiye)	APPLICATION OF ORGANOSOLV METHOD TO OBTAIN HIGH CELLULOSE CONTAINING PRODUCT FROM MEDIUM DENSITY FIBERBOARD POWDER
Dyt. Uğur Sevim KALENDER Prof. Dr. Yasemin BEYHAN	Hasan Kalyoncu Univeristy (Türkiye)	INVESTIGATION OF THE RELATIONSHIP BETWEEN HEDONIC HUNGER AND MEDITERRANEAN DIET IN WORKING AND NON-WORKING WOMEN
Marwa TAINSA Assist. Prof. Dr. İsmail Hakkı TEKİNER	Saad Dahleb University (Algeria) Istanbul Sabahattin Zaim University (Türkiye)	BIOCHEMICAL BALLET OF SOURDOUGH WITH MICROBIOTA: METABOLIC AND NUTRITIONAL PERSPECTIVES ON FOOD QUALITY AND HEALTH

17.01.2024 | HALL-4



Ankara Local Time: 13<sup>00</sup>-15<sup>00</sup>

HEAD OF SESSION: Dr. Ivan PAVLOVIC

AUTHORS	AFFILIATION	TOPIC TITLE
Ilijan MALOLLARI Hasime MANAJ Sami MAKOLLI Anisa DHROSO	<i>University of Tirana (Albania)</i>	BIOENERGY – ITS PRESENT AND FUTURE DUTY IN THE RENEWABLE ENERGY SYSTEM
Ilijan MALOLLARI Redi BUZO Luljeta PINGULI Fjora CANE	<i>University of Tirana (Albania)</i>	SIMULATION OF POLYLACTIC ACID AND XYLITOL PRODUCTION FROM THE BREWER'S SPENT GRAINS
Dr. Mahmood AHMED	<i>University of Education (Pakistan)</i>	IBUPROFEN CONJUGATED SULFONAMIDES AS UREASE INHIBITORS
Dr. Ivan PAVLOVIC	<i>Scientific Institute of Veterinary Medicine of Serbia (Serbia)</i>	TETRAMERIASIS OF PHEASANTS IN SPRED BELGRADE AREA
TOUGHZAOUI Abdelilah CHEDADI Oussama EL AISSOUQ Abdellah EL OUARDI Youssef BOUACHRINE Mohammed OUAMMOU Abdelkrim MORADI Kamal	<i>Sidi Mohamed Ben Abdellah University (Morocco)</i>	COMPUTATIONAL STUDY OF NEW BENZOSULFONAMIDES AS TRPV4 ANTAGONISTS USING 3D-QSAR, MOLECULAR DOCKING, MOLECULAR DYNAMICS AND ADMET PREDICTION
Hertiana IKASARI FX. SUGIYANTO Akhnad Syakir KURNIA	<i>Dian Nuswantoro University (Indonesia) Diponegoro University (Indonesia)</i>	TOTAL FACTOR PRODUCTIVITY (TFP) OF THE INDONESIAN MANUFACTURING INDUSTRY USING LEVINSHON- PETRIN APPROACH
Hiba SHAHID Prof. Dr. Syed Ali Raza NAQVI	<i>Government College University Faisalabad (Pakistan)</i>	ANTIOXIDANT, ENZYME INHIBITION AND TOXICOLOGY STUDIES OF METHANOL EXTRACTS OF SELECTED MEDICINAL PLANTS
USMAN SANI KK Dr. Abubakar LAWAL	<i>Umaru Musa Yar adua University Katsina (Nigeria)</i>	DETERMINATION OF THE TOXICITY LEVEL OF NICOTINE FROM INHALED CIGARETTE USING ALBINO RAT OF PROJECT REPORT
Rawayau A. MANNIR Sani A. YANDOMA Muhammad F. LAWAL Sani AHMED	<i>Umaru Musa Yaradua University (Nigeria)</i>	PROXIMATE, VITAMINS, IN VITRO ANTIOXIDANT AND FUNCTIONAL ANALYSIS OF SOME POLYHERBAL FORMULATIONS AS POTENTIAL BOTANICAL CANDIDATES FOR PHARMACEUTICAL SCREENING. GINGER, GARLIC AND CLOVE (GGC)
Khalil El KHATABI Mohammed Aziz AJANA Tahar LAKHLIFI Mohammed BOUACHRINE	<i>Sultan Moulay Sliman University (Morocco)</i>	IDENTIFICATION OF NOVEL POTENTIAL ACETYLCHOLINESTERASE INHIBITORS THROUGH 3D-QSAR, DOCKING AND MOLECULAR DYNAMICS SIMULATIONS TARGETING ALZHEIMER'S DISEASE

17.01.2024 | HALL-5



Ankara Local Time: 13<sup>00</sup>-15<sup>00</sup>

**HEAD OF SESSION: Assist. Prof. Dr. Bilal AHMED**

<b>AUTHORS</b>	<b>AFFILIATION</b>	<b>TOPIC TITLE</b>
Assist. Prof. Dr. Bilal AHMED	<i>University of Science and Technology of Fujairah (UAE)</i>	ANALYZING MAGNETO HYDRODYNAMIC BLOOD FLOW CONVINCED PERISTALTICALLY: A STUDY OF NON-LINEAR MODELS IN AN ASYMMETRIC CHANNEL
Aniekan Essienubong IKPE Jephtar Uviefowwe OHWOEKEVWO	<i>Akwa Ibom State Polytechnic (Nigeria)</i> <i>University of Benin (Benin)</i>	INTELLIGENT TRANSPORTATION SYSTEMS AS A PIVOTAL INSTRUMENT IN THE DEVELOPMENT OF SMART CITIES IN THE 21st CENTURY
Imoh Ime EKANEM Aniekan Essienubong IKPE Eyo Sunday ABIA	<i>Akwa Ibom State Polytechnic (Nigeria)</i> <i>University of Cross River State (Nigeria)</i>	EVOLUTION OF FORMULA ONE (F1) MOTORSPORTS AND ITS TOP-NOTCH ADVANCEMENT IN ENGINEERING INNOVATIONS ACROSS THE RACING INDUSTRY
Dr. Muhammad Aminu MUSA	<i>Ahmadu Bello University (Nigeria)</i>	A MATHEMATICAL MODEL FOR OPTIMISING PASSIVE INDOOR THERMAL AND VISUAL COMFORT IN SINGLE BANKED OFFICE BUILDINGS IN TEMPERATE DRY CLIMATE OF NIGERIA
Dr. Binyam ZIGTA	<i>Wachemo University (Ethiopia)</i>	NUMERICAL STUDY OF PHYSIOLOGICAL BLOOD FLOW WITH STRETCHING CAPILLARY ON MHD MICROPOLAR FLUID
Khaoula MKHAYAR Kaouakeb El Khattabi Samir CHTITA Souad ELKHATTABI	<i>Sidi Mohamed Ben Abdellah-Fez University (Morocco)</i> <i>Mohammed V University (Morocco)</i> <i>Hassan II University (Morocco)</i>	DESIGN NOVEL ANTICANCER AGENTS FOR HUMAN BREAST CANCER CELL LINE: EXPLORING VIA QSAR AND MOLECULAR DOCKING ANALYSES
Neha SINGH Suneel KUMAR	<i>Mangalayatan University (India)</i>	A REVIEW: CHOLESTEROL AND ITS MANAGEMENT
Major Gheorghe GIURGIU Prof. dr. Manole COJOCARU	<i>Deniplant-Aide Sante Medical Center (Romania)</i> <i>Titu Maiorescu University (Romania)</i>	GUT DYSBIOSIS IN DOGS WITH SPINAL CORD INJURY: IMPACT OF POLENOPLASMIN
Priyanshi GOYAL	<i>Mangalayatan University (India)</i>	ROLE OF NANOROBOTICS IN HEALTHCARE
Assist. Prof. Dr. Bayurzhan SAIFUNOV Ayaulym SERIK	<i>Hoca Ahmet Yesevi Turkish-Kazakh University (Kazakhstan)</i>	RELIGIOUS MOVEMENT «ALLATRA»
Isma'il IBRAHİM Yusuf HASSAN	<i>Umaru Musa Yar'adua University (Nigeria)</i>	SYNTHESIS AND ANTIMICROBIAL ACTIVITY OF 2-METHOXY-4-[(2-PHENYLHYDRAZONO) METHYL] PHENOL
Arwa Abdul Magid Mohamed Elmahjubi	<i>Tripoli University (Libya)</i>	THE ROLE OF TOURISM ADVERTISING IN THE PROMOTION OF TOURISM SECTOR APPLIED STUDY ON THE LIBYAN TOURISM MINISTRY
Mr. Salem Mansour Gwirb Mr. Ebrahim Mohamed Alawj	<i>Hospitality Musrata (Libya)</i>	THE ROLE OF TRAINING PROGRAMS IN INCREASING THE LEVEL OF FAMILIARITY OF JOB PERFORMANCE APPLIED STUDY ON BAB ALBAHAR HOTEL IN TRIPOLI – LIBYA

17.01.2024 | HALL-6



Ankara Local Time: 13<sup>00</sup>-15<sup>00</sup>

HEAD OF SESSION: Dr. Ülker SAMEDOVA

AUTHORS	AFFILIATION	TOPIC TITLE
Eleonora Lutvig gizi Babayeva	<i>Azerbaijan University of Languages (Azerbaijan)</i>	THE PROBLEM OF STYLISTIC DEVICES AND EXPRESSIVE MEANS IN TRANSLATION BASED ON THE BOOK "THE IMAGE OF AZERBAIJAN IN THE ENGLISH LANGUAGE PRESS DURING THE PERIOD OF INDEPENDENCE"
Dr. Ülker SAMEDOVA	<i>Azerbaijan National Academy of Sciences (Azerbaijan)</i>	THE INFLUENCE OF FRENCH LITERATURE ON THE OTTOMAN LITERATURE
Alakbarova Khumar Elham	<i>Azerbaijan National Academy of Sciences (Azerbaijan)</i>	ALGERIAN LITERATURE AGAINST FRENCH COLONIAL POLICY
Fr. Baiju THOMAS	<i>Ramakrishna Mission Vivekananda Educational And Research Institute (India)</i>	FOSTERING AN UNDERSTANDING OF E-WASTE MANAGEMENT AMONG STUDENTS IN MODERN EDUCATIONAL SYSTEMS
Mohd SUALH Saifullah REHMANI	<i>Aligarh Muslim University (India)</i>	NAVIGATING THE INTERSECTION: ISLAM AND SECULARISM IN CONTEMPORARY SOCIETIES
Irina-Ana DROBOT	<i>Technical University of Civil Engineering Bucharest (Romania)</i>	THE MEANING OF JEWELRY FOR WOMEN IN INDIAN AND MOROCCAN CULTURES
Julius Oluwayomi OLUWADAMILARE	<i>University of Ilesa (Nigeria)</i>	WOMEN AS TRADITIONAL MUSIC EDUCATORS AMONG YORUBA OF SOUTHWEST NIGERIA: LEARNING FROM THE PAST AND THE PRESENT TO PROJECT THE FUTURE
Assoc. Prof. Dr. Romanova ANASTASIA	<i>The Academy of Economic Studies of Moldova</i>	LEARNING TO LISTEN: SOME LISTENING COMPREHENSION STRATEGIESE
Jean-Marc GNONLONFOUN	<i>National University of Sciences and Technologies (West Africa)</i>	EXPLORING EMPLOYMENT SUCCESS OF LEARNERS WITH DISABILITIES UPON GRADUATION FROM HAIRDRESSING PROGRAM IN SELECTED BENINESE VOCATIONAL AND TECHNICAL EDUCATION CENTRES
Zohaib Hassan SAIN	<i>Superior University (Pakistan)</i>	SUSTAINABLE DEVELOPMENT: CHALLENGES AND STRATEGIES IN SOUTH ASIA, SPOTLIGHTING PAKISTANI HIGHER EDUCATION
Zohaib Hassan SAIN	<i>Superior University (Pakistan)</i>	THE INTEGRATION OF ARTIFICIAL INTELLIGENCE FOR HIGHER EDUCATION ADVANCEMENT IN PAKISTAN
Assoc. Prof. Dr. Gafarova Parvin MUHAMAD	<i>Azerbaijan State Pedagogical University (Azerbaijan)</i>	PRINCIPLES OF ORGANIZATION OF WORK WITH ELECTRONIC TEXTBOOKS IN TEACHING BIOLOGY TO STUDENTS
Mr. Ali Alesawe Nasser	<i>University of Naloot (Libya)</i>	THE IMPACT OF MARKETING MIX ON THE BANK SERVICES QUALITY APPLIED STUDY ON ALAMMAN BANK, NALOOUT CITY- LIBYA





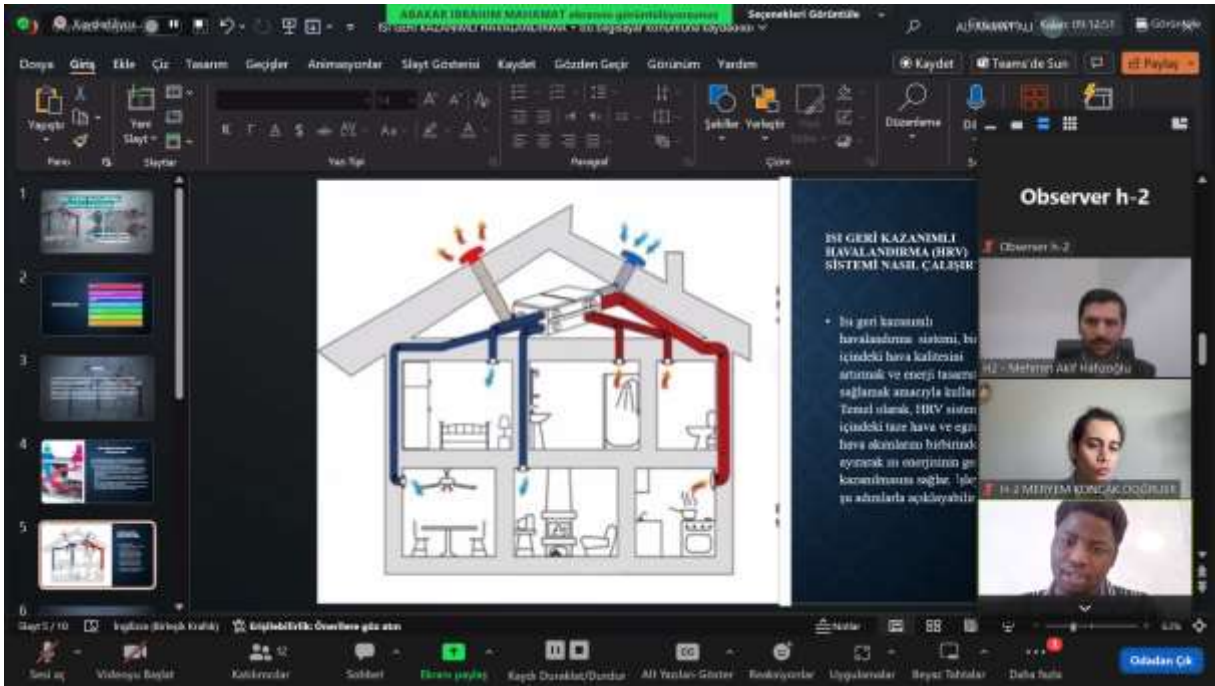





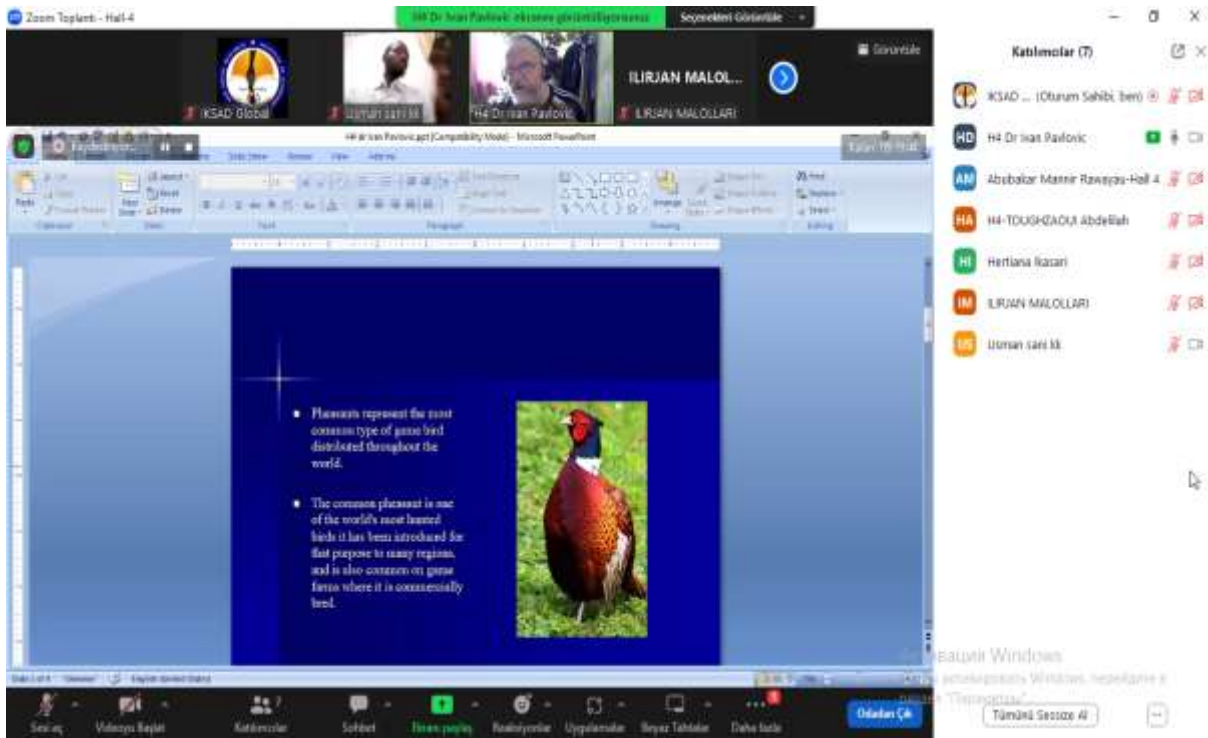



Zoom Toplantı - Hall-5

H 5 .Gheorghe Giurgiu... mihayar khaoula

Observer Hall-5 H 5 .Gheorghe... mihayar khaoula

Kayıtlılar

**GUT DYSBIOSIS IN DOGS WITH SPINAL CORD INJURY:  
IMPACT OF POLENOPLASMIN**

Major Gheorghe Giurgiu<sup>1</sup>, Prof dr med Manole Cojocaru<sup>2</sup>

<sup>1</sup>Deniplant-Aide Sante Medical Center, Biomedicine, Bucharest, Romania  
[deniplant@gmail.com](mailto:deniplant@gmail.com); Telephone: +40 744 827 881  
<https://orcid.org/0000-0002-5449-2712>

<sup>2</sup>Member of Academy of Romanian Scientists, Scientific Researcher degree I  
 Titu Maiorescu University, Faculty of Medicine, Bucharest, Romania  
 Professor of Allergology and Clinical Immunology  
 European Specialist of Laboratory Medicine  
 Senior Specialist of Allergology and Clinical Immunology  
[cojocaru.manole@gmail.com](mailto:cojocaru.manole@gmail.com); Telephone: +40 723 326 663  
<https://orcid.org/0000-0002-7192-7490>

Sesli aç Videyo Başlat Katılımcılar Sohbet Ekran paylaş Tezdeyirtiler Uygulamalar Beyaz Tahtalar Daha fazla

Odaın Çık

Tümünü Sesizle Al

Zoom Toplantı - Hall-5

Aniekan Ike... mihayar khaoula

Observer Hall-5 Aniekan Ike H 5 .Gheorghe... mihayar khaoula

Kayıtlılar

**ATLAS 11<sup>TH</sup> INTERNATIONAL CONGRESS ON ADVANCED SCIENTIFIC STUDIES  
AND INTERDISCIPLINARY RESEARCH**

**EVOLUTION OF FORMULA ONE (F1) MOTORSPORTS AND ITS TOP-NOTCH  
ADVANCEMENT IN ENGINEERING INNOVATIONS ACROSS THE RACING  
INDUSTRY**

Imoh Ime Ekanem (ORCID ID: 0000-0002-8973-9260)  
 Aniekan Essienubong Ikpe (ORCID ID: 0000-0001-9069-9676)  
 Eyo Sunday Abia (ORCID ID: 0009-0008-7308-570X)

JANUARY 2024

Sesizle Videyo Başlat Katılımcılar Sohbet Ekran paylaş Tezdeyirtiler Uygulamalar Beyaz Tahtalar Daha fazla

Odaın Çık

Tümünü Sesizle Al



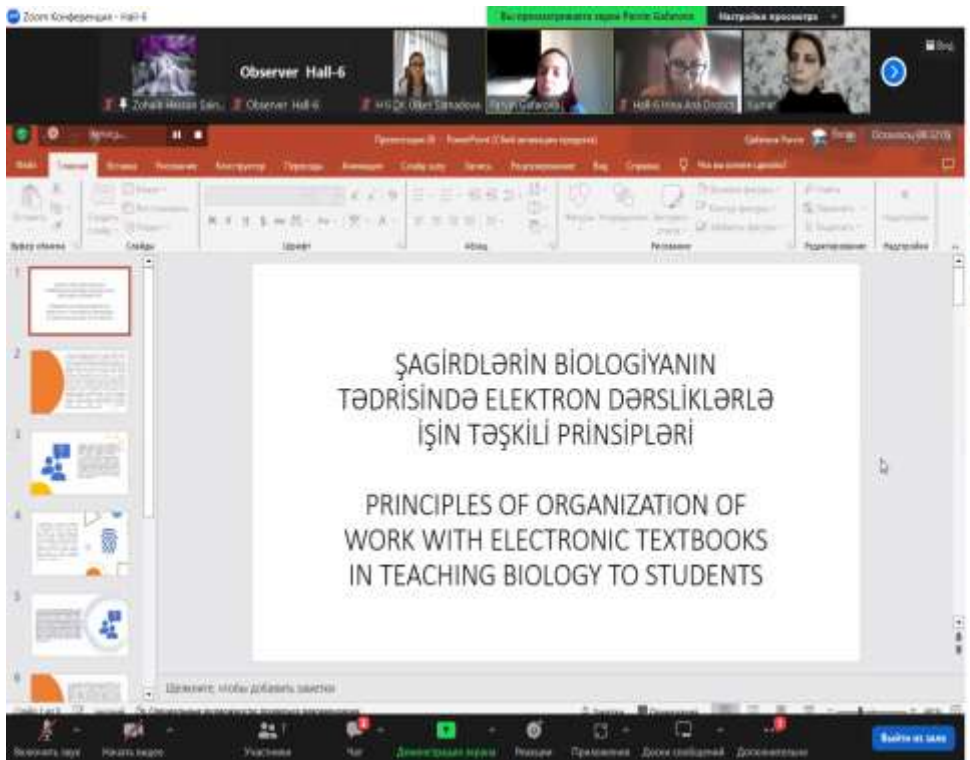

# CONTENT

<b>CONGRESS ID</b>	<b>I</b>
<b>PROGRAM</b>	<b>II</b>
<b>PHOTO GALLERY</b>	<b>III</b>
<b>CONTENT</b>	<b>V</b>

Author	Title	No
Uğur GÜREL Merve CEYHAN	EARTQUAKE ASSISTANCE PLATFORM	1
Merve CEYHAN Uğur GÜREL	RADIOMIC FEATURE EXTRACTION IN CANCER-SPECIFIC PREDICTIVE MODELING	2
Hiba SHAHID Prof. Dr. Syed Ali Raza NAQVI	ANTIOXIDANT, ENZYME INHIBITION AND TOXICOLOGY STUDIES OF METHANOL EXTRACTS OF SELECTED MEDICINAL PLANTS	11
Priyanshi GOYAL	ROLE OF NANOROBOTICS IN HEALTHCARE	13
Iirjan MALOLLARI Hasime MANAJ Sami MAKOLLI Anisa DHROSO	BIOENERGY – ITS PRESENT AND FUTURE DUTY IN THE RENEWABLE ENERGY SYSTEM	14
Iirjan MALOLLARI Redi BUZO Luljeta PINGULI Fjora CANE	SIMULATION OF POLYLACTIC ACID AND XYLITOL PRODUCTION FROM THE BREWER'S SPENT GRAINS	15
Khaoula MKHAYAR Kaouakeb El Khattabi Samir CHTITA Souad ELKHATTABI	DESIGN NOVEL ANTICANCER AGENTS FOR HUMAN BREAST CANCER CELL LINE: EXPLORING VIA QSAR AND MOLECULAR DOCKING ANALYSES	16
Hertiana IKASARI FX. SUGIYANTO Akhmad Syakir KURNIA	TOTAL FACTOR PRODUCTIVITY (TFP) OF THE INDONESIAN MANUFACTURING INDUSTRY USING LEVINSHON-PETRIN APPROACH	17
Arwa Abdul Magid Mohamed Elmahjubi	THE ROLE OF TOURISM ADVERTISING IN THE PROMOTION OF TOURISM SECTOR APPLIED STUDY ON THE LIBYAN TOURISM MINISTRY	18
Ahmet ÖZBAY Melis KARAKAŞ	NARCISSISTIC PERSONALITY DISORDER AND ITS TREATMENTS WITHIN THE FRAMEWORK OF PSYCHOTHERAPY APPROACHS	26
Ulker SAMADOVA	THE INFLUENCE OF FRENCH LITERATURE ON THE OTTOMAN LITERATURE	46
Beyza DURUCU	PACKAGING COLLABORATIONS WITH ARTIFICIAL INTELLIGENCE	52
Pelın YAZICI KARAYAĞIZ	ALTERNATIVE METHODS AND TECHNOLOGIES TO THE USE OF SO <sub>2</sub> IN WINE PRODUCTION	53

Muhammet TORTUMLU Kıvanç UZUN	THE PREDICTIVE ROLE OF YOUNG ADULTS' CAREER PLANNING SKILLS ON THEIR CAREER OPTIMISM AND EMPLOYMENT HOPE	54
Gülçin SAĞIR KESKİN	DISCUSING THE CONCEPTS OF SOVEREIGNTY AND STATE OF EMERGENCY THROUGH CARL SCHMITT	70
TOUGHZAOUI Abdelilah CHEDADI Oussama EL AISSOUQ Abdellah EL OUARDI Youssef BOUACHRINE Mohammed OUAMMOU Abdelkrim MORADI Kamal	COMPUTATIONAL STUDY OF NEW BENZOSULFONAMIDES AS TRPV4 ANTAGONISTS USING 3D-QSAR, MOLECULAR DOCKING, MOLECULAR DYNAMICS AND ADMET PREDICTION	72
Dilber ÇAĞLAR	FOODS WITH POSTBIOTIC AND SYMBIOTIC PROPERTIES	73
Alakbarova Khumar Elham	ALGERIAN LITERATURE AGAINST FRENCH COLONIAL POLICY	75
Sezen TEKİN Tuğba ÇORLU Irmak KARADUMAN ER Selim ACAR	INVESTIGATION OF OPTICAL AND PHOTOSENSOR PROPERTIES OF La-DOPED ZnNiO THIN FILMS	78
Irina-Ana DROBOT	THE MEANING OF JEWELRY FOR WOMEN IN INDIAN AND MOROCCAN CULTURES	87
Sevinç TAY Murat YILMAZTEKİN	ENCAPSULATION OF GREEN TEA EXTRACT BY ELECTROSTATIC EXTRUSION TECHNIQUE	101
Bahar YAKUT ÖZEK	PHILOSOPHICAL THINKING IN EARLY CHILDHOOD EDUCATION: DEVELOPING CRITICAL THINKING SKILLS WITH P4C	104
Imoh Ime EKANEM Aniekan Essienubong IKPE Eyo Sunday ABIA	EVOLUTION OF FORMULA ONE (F1) MOTORSPORTS AND ITS TOP-NOTCH ADVANCEMENT IN ENGINEERING INNOVATIONS ACROSS THE RACING INDUSTRY	107
Uğur Sevim KALENDER Yasemin BEYHAN	INVESTIGATION OF THE RELATIONSHIP BETWEEN HEDONIC HUNGER AND MEDITERRANEAN DIET IN WORKING AND NON-WORKING WOMEN	128
Baiju THOMAS	FOSTERING AN UNDERSTANDING OF E- WASTE MANAGEMENT AMONG STUDENTS IN MODERN EDUCATIONAL SYSTEMS	142
Mehmet Akif HAFIZOĞLU	ADHESIVE WEAR INVESTIGATION OF GLASS FIBER MATERIALS	143
Rawayau A. MANNIR Sani A. YANDOMA Muhammad F. LAWAL Sani AHMED	PROXIMATE, VITAMINS, IN VITRO ANTIOXIDANT AND FUNCTIONAL ANALYSIS OF SOME POLYHERBAL FORMULATIONS AS POTENTIAL BOTANICAL CANDIDATES FOR PHARMACEUTICAL SCREENING. GINGER, GARLIC AND CLOVE (GGC)	149

Mustafa KOÇ	PICKPOCKETING IN ISTANBUL (1934-1935)	166
Gheorghe GIURGIU Manole COJOCARU	GUT DYSBIOSIS IN DOGS WITH SPINAL CORD INJURY: IMPACT OF POLENOPLASMIN	174
Jean-Marc GNONLONFOUN	EXPLORING EMPLOYMENT SUCCESS OF LEARNERS WITH DISABILITIES UPON GRADUATION FROM HAIRDRESSING PROGRAM IN SELECTED BENINESE VOCATIONAL AND TECHNICAL EDUCATION CENTRES	175
Mahmood AHMED	IBUPROFEN CONJUGATED SULFONAMIDES AS UREASE INHIBITORS	176
Khalil El KHATABI Mohammed Aziz AJANA Tahar LAKHLIFI Mohammed BOUACHRINE	IDENTIFICATION OF NOVEL POTENTIAL ACETYLCHOLINESTERASE INHIBITORS THROUGH 3D-QSAR, DOCKING AND MOLECULAR DYNAMICS SIMULATIONS TARGETING ALZHEIMER'S DISEASE	177
Aniekan Essienubong Ikpe Jephtar Uviefowwe Ohwoekevwo	INTELLIGENT TRANSPORTATION SYSTEMS AS A PIVOTAL INSTRUMENT IN THE DEVELOPMENT OF SMART CITIES IN THE 21 <sup>st</sup> CENTURY	179
Kerim İŞLER Eser Burak GEZEN Metem KALYONCU	INVESTIGATION OF THE EFFECTS OF DIFFERENT REFRIGERANTS ON THE CAPACITY OF A FINNED-TUBE CONDENSER USING UNILAB COILS SOFTWARE	198
Ceyhun ŞAKIROĞLU	TOLERANCE IN RELATIONS BETWEEN CIVILIZATIONS IN THE AGE OF GLOBALIZATION PROBLEMS OF THE FORMATION AND DEVELOPMENT OF THE ENVIRONMENT	200
Romanova ANASTASIA	LEARNING TO LISTEN: SOME LISTENING COMPREHENSION STRATEGIES	202
Muhammad Aminu MUSA	A MATHEMATICAL MODEL FOR OPTIMISING PASSIVE INDOOR THERMAL AND VISUAL COMFORT IN SINGLE BANKED OFFICE BUILDINGS IN TEMPERATE DRY CLIMATE OF NIGERIA	203
Bilal AHMED	ANALYZING MAGNETO HYDRODYNAMIC BLOOD FLOW CONVINCED PERISTALTICALLY: A STUDY OF NON-LINEAR MODELS IN AN ASYMMETRIC CHANNEL	204
Eleonora Lutvig gizi Babayeva	THE PROBLEM OF STYLISTIC DEVICES AND EXPRESSIVE MEANS IN TRANSLATION BASED ON THE BOOK "THE IMAGE OF AZERBAIJAN IN THE ENGLISH LANGUAGE PRESS DURING THE PERIOD OF INDEPENDENCE"	205



Isma'il IBRAHIM Yusuf HASSAN	SYNTHESIS AND ANTIMICROBIAL ACTIVITY OF 2-METHOXY-4-[(2- PHENYLHYDRAZONO) METHYL] PHENOL	206
Mohd SUALH Saifullah REHMANI	NAVIGATING THE INTERSECTION: ISLAM AND SECULARISM IN CONTEMPORARY SOCIETIES	207
Binyam ZIGTA	NUMERICAL STUDY OF PHYSIOLOGICAL BLOOD FLOW WITH STRETCHING CAPILLARY ON MHD MICROPOLAR FLUID	208
Tülay GÜRSOY Nurhayat ATASOY	HEAVY METAL CONTENT OF THE LINDEN PLANT GROWED IN VAN/TURKEY PROVINCE	209
Tülay GÜRSOY Nurhayat ATASOY	HEAVY METAL CONTENT OF THE WATERCANE PLANT GROWED IN VAN/TURKEY PROVINCE	211
Neha SINGH Suneel KUMAR	A REVIEW: CHOLESTEROL AND ITS MANAGEMENT	213
Salem Mansour GWIRB Ebrahim Mohamed ALAWJ	THE ROLE OF TRAINING PROGRAMS IN INCREASING THE LEVEL OF FAMILIARITY OF JOB PERFORMANCE APPLIED STUDY ON BAB ALBAHAR HOTEL IN TRIPOLI – LIBYA	214
Kübra İNÇ H. Soner ALTUNDOĞAN	APPLICATION OF ORGANOSOLV METHOD TO OBTAIN HIGH CELLULOSE CONTAINING PRODUCT FROM MEDIUM DENSITY FIBERBOARD POWDER	223
Marwa TAINSA İsmail Hakkı TEKİNER	BIOCHEMICAL BALLET OF SOURDOUGH WITH MICROBIOTA: METABOLIC AND NUTRITIONAL PERSPECTIVES ON FOOD QUALITY AND HEALTH	225
Bahar YAKUT ÖZEK	DEVELOPMENT OF CRITICAL THINKING SKILLS IN PRESCHOOL PERIOD	226
Zohaib Hassan SAIN	SUSTAINABLE DEVELOPMENT: CHALLENGES AND STRATEGIES IN SOUTH ASIA, SPOTLIGHTING PAKISTANI HIGHER EDUCATION	228
Zohaib Hassan SAIN	THE INTEGRATION OF ARTIFICIAL INTELLIGENCE FOR HIGHER EDUCATION ADVANCEMENT IN PAKISTAN	229
Gafarova Parvin MUHAMAD	PRINCIPLES OF ORGANIZATION OF WORK WITH ELECTRONIC TEXTBOOKS IN TEACHING BIOLOGY TO STUDENTS	230
Meryem KONCAK DOĞRUER	POPULATION DEVELOPMENT IN KÖYCEĞİZ PROVINCE	237
Mustafa BUĞDAY Abakar IBRAHİM MAHAMAT Yacoub NAGI MOHAMED Adam HISSEIENE MAHAMAT	HEAT RECOVERY VENTILATION	239

Fatma ERASLAN Mustafa UYANIK	MAKDISI IN THE CONTEXT OF ITS CONTRIBUTION TO HISTORICAL GEOGRAPHY	243
Ivan PAVLOVIC	TETRAMERIASIS OF PHEASANTS IN SPRED BELGRADE AREA	245
Ali Aleisawi NASR	THE IMPACT OF MARKETING MIX ON THE IMPROVEMENT OF BANKING SERVICE QUALITY APPLIED STUDY ON ALAMMAN BANK, NALOOUT CITY- LIBYA	246
Tuğba ÖNEY	OTTOMAN FOUNDATIONS AND THEIR SOCIAL FUNCTIONALITY: THE CASE OF BURSA PROVINCE	262
Usman SANI KK Abubakar LAWAL	DETERMINATION OF THE TOXICITY LEVEL OF NICOTINE FROM INHALED CIGARETTE USING ALBINO RAT	272
Julius Oluwayomi OLUWADAMILARE	WOMEN AS TRADITIONAL MUSIC EDUCATORS AMONG YORUBA OF SOUTHWEST NIGERIA: LEARNING FROM THE PAST AND THE PRESENT TO PROJECT THE FUTURE	282
Yusuf SAYAR	TÜRKİYE-USA RELATIONS BETWEEN 1960- 1970	283
Zehra GÖZÜTOK TAMDOĞAN	TUNUSIAN PILGRIM GUEST of ISTANBUL in 1882: MUHAMMAD AL-SENUSI	291
Bayurzhan SAĪFUNOV Ayaulym SERİK	RELIGIOUS MOVEMENT «ALLATRA»	293



## EARTQUAKE ASSISTANCE PLATFORM

**Dr. Öğr. Üyesi Uğur GÜREL**

Eskişehir Osmangazi Üniversitesi,  
ORCID: 0000-0001-9088-1515

**Araş. Gör. Merve CEYHAN**

Eskişehir Osmangazi Üniversitesi,  
ORCID NO: 0000-0003-0733-3652

### ABSTRACT

This study aims to build a platform for coordinating earthquake victims and volunteer aids effectively. Over the last century, numerous earthquakes have occurred, affecting both our nation and the global landscape, causing extensive damage in the regions they impacted. Due to these earthquakes, challenges arose in delivering collected aid to the affected areas, leading to instances where this circumstance resulted in the loss of human lives. The objective of this paper is to create a web application with the purpose of swiftly and efficiently delivering essential aid to the affected areas following an earthquake. A web-based software system has been crafted to facilitate earthquake victims with internet access, allowing them to submit their aid requests. At the same time, donors seeking help can publish their assistance through the same platform. The web project has been formulated considering pertinent data integrity, security, and speed advancements within relevant technical developments. The system's broadcasting service communicates with the web application through a Rest API, and user requests are processed within the system through this service. As a result of this paper, it is clearly shown that this developed system can be used to combine earthquake victims and volunteer aids. Mobile applications can be built as future work. The practical part of the study was done by Ömer Faruk LALE and Mesut KIZILAY, we thank them.

**Keywords:** Earthquake, web applications, rest API



## KANSERE ÖZGÜ ÖNGÖRÜCÜ MODELLEMEDE RADYOMİK ÖZELLİK ÇIKARILMASI

RADIOMIC FEATURE EXTRACTION IN CANCER-SPECIFIC PREDICTIVE MODELING

**Araş. Gör. Merve CEYHAN**

Eskişehir Osmangazi Üniversitesi,  
ORCID NO: 0000-0003-0733-3652

**Dr. Öğr. Üyesi Uğur GÜREL**

Eskişehir Osmangazi Üniversitesi,  
ORCID: 0000-0001-9088-1515

### ÖZET

Medikal görüntülerin analiz edilerek kapsamlı incelenmesi ve barındırdıkları çeşitli özelliklerin çıkartılması yaklaşımı radyomik olarak ifade edilir. Bu yaklaşım ile bilgisayar tabanlı medikal veriler nitel ve nicel analizlerle daha detaylı incelenme imkânı bulur. Bu analizler sonucu elde edilen sonuçlar hastalıkların tanısı, tedavisi ve prognozu açısından önemli avantajlar sağlamaktadır. Radyomik üzerine yürütülen çalışmalar hastalıkların tespit ve tedavisindeki etkinliği artırmaya yönelik olarak derin öğrenme yöntemlerine entegre edilmektedir. Derin öğrenme, veri setleri üzerinde matematiksel hesaplamalar sonucu bazı önemli saklı özellikleri çıkararak ve bu özellikleri ayırt edici düzeyde yakalayan algoritmalar içermektedir. Radyomik verilerin derin öğrenme yöntemlerinde kullanılması medikal görüntülerdeki saklı özelliklerin ortaya çıkarılmasına ve hastalıkların erken dönemlerde tespitine olanak vermektedir. Derin öğrenme modelleri, görüntüleme işaretçileri oluşturarak hastalıkların karakteristik özelliklerinin daha iyi anlaşılmasına ve kişiselleştirilmiş tedavi stratejilerinin oluşturulmasına imkân sağlar. Radyomik ve derin öğrenme birleşimi, özellikle onkoloji çalışmalarında tümörlerin karakterize edilmesi, sınıflandırılması ve tedaviye yanıtın belirlenmesi gibi klinik uygulamalarda büyük potansiyel taşımaktadır. Radyomik ve derin öğrenme yöntemleri arasındaki ilişki, medikal görüntülerin etkili bir şekilde analiz edilmesine, hastalıkların erken dönemde tespit edilmesine, tedavi planlarının optimize edilmesine olanak sağlamaktadır.

**Anahtar Kelimeler:** Radyomik, Özellik Çıkarımı, Derin Öğrenme, Kanser Tespiti, Analiz.

### ABSTRACT

The approach of analyzing medical images comprehensively and extracting their various features is referred to as radiomics. With this approach, computer-based medical data can be examined more thoroughly with qualitative and quantitative analyses. The results obtained from these analyses provide significant advantages in terms of disease diagnosis, treatment, and prognosis. Studies on radiomics are integrated with deep learning methods to increase the



effectiveness in detecting and treating diseases. Deep learning includes algorithms that extract important hidden features from mathematical calculations on data sets and capture these features at a distinctive level. Using radiomic data in deep learning allows for discovering hidden features in medical images and detecting diseases at early stages. Deep learning models create imaging markers, allowing a better understanding of the characteristics of diseases and the creation of personalized treatment strategies. The combination of radiomics and deep learning has great potential in clinical applications such as characterizing and classifying tumors and determining response to treatment, especially in oncology studies. The relationship between radiomics and deep learning methods allows practical analysis of medical images, early detection of diseases, and optimization of treatment plans.

**Keywords:** Radiomic, Feature Extraction, Deep Learning, Cancer Detection, Analysis.

## GİRİŞ

Radyomik, radyoloji ve omik kavramlarını birleştiren bir kelimedir. Radyomik veriler, bilgisayarlı tomografi, manyetik rezonans görüntüleme ve X ışınları gibi tıbbi görüntülerin analiz edilmesiyle elde edilen genetik ve moleküler verileri ifade eder (Van Timmeren, Cester, Tanadini-Lang, Alkadhi, & Baessler, 2020). Radyomik verileri hastalık özelliklerini net bir şekilde yakalayabilir, kişiselleştirilmiş tedavileri belirleyebilir ve hastalığı erken aşamalarında tespit edebilir. Bu özellikleriyle radyomik, tıbbi görüntüleme giderek büyüyen bir araştırma alanı haline gelmektedir.

Tıbbi görüntüleme verileri çeşitli yöntemlerle elde edilebilir. Bunlardan en yaygın olanları CT (bilgisayarlı tomografi), MR (manyetik rezonans görüntüleme), PET (pozitron emisyon tomografisi), ultrason ve X ışınlarıdır (Pichler, Judenhofer, & Pfannenber, 2008). CT, vücudun ayrıntılı bir kesitsel görüntüsünü oluşturmak için X ışınlarını kullanır ve organların, dokuların ve lezyonların ayrıntılı bir anatomik haritasını sağlar. CT görüntüleri analiz edilerek yoğunluk, şekil, boyut ve heterojenlik özellikleri gibi radyomik veriler elde edilebilir. MR, vücudun ayrıntılı görüntülerini elde etmek için güçlü manyetik alanlar ve radyo dalgalarını kullanır. PET vücuttaki metabolik aktiviteyi ölçmek için kullanılır. PET görüntülerinin hücre aktivitesi, metabolik yoğunluk, lezyon dağılım hızı açısından analiz edilmesiyle radyomik veriler elde edilebilir. Ultrason, vücuttaki yapıları görselleştirmek için ses dalgalarını kullanan bir yöntemdir. Ultrason görüntülerindeki radyomik imzalar lezyon şekli, boyutu ve yoğunluğu gibi özelliklerin analiz edilmesiyle de elde edilebilir. Kemikleri ve belirli dokuları incelemek için röntgen uygulanır. Kemik yoğunluğu ve lezyon görünürlüğü gibi özellikler, X-ışını görüntülerinde radyomik imzalar sağlar. Bu tıbbi görüntüleme kaynaklarından elde edilen veriler, daha spesifik bilgi sağlamak amacıyla radyomik özellikleri çıkarmak için analiz edilebilir.



Radyomik verilerin kendisi bölgesel özellikler, yoğunluk ve heterojenlik özellikleri, şekil ve yapısal özellikler, istatistiksel özellikler, doku özellikleri, morfolojik özellikler, damarsal özellikler ve spektral özellik gibi farklı özelliklere sahiptir (Lee et al., 2017). Bölgesel özellikler, görüntü üzerinde belirli bir bölgeyi temsil eden özelliklerdir. Bir tümörün boyutu, şekli veya içerdiği piksel yoğunluğu bölgesel özelliklere örnek olarak verilebilir. Yoğunluk ve heterojenlik özellikleri, görüntüdeki piksellerin yoğunluğu ve tümör gibi bölgelerin heterojenliği gibi özellikleri ifade eder. Tümörün kenar düzenliliği, simetri gibi özellikler şekil ve yapısal özelliklerdendir. Görüntü piksellerinin analizi sonucu elde edilen ortalama yoğunluk, standart sapma gibi özellikler istatistiksel özelliklerdendir. Görüntü içindeki doku desenlerini ifade eden özellikler tekstür özellikleri olarak ele alınmaktadır. Görüntülerdeki nesnelerin şekli ve yapısal özelliklerine odaklanan morfolojik özelliklerdir. Vasküler Özellikler, görüntüdeki damar yapılarına ilişkin özelliklerdir. Görüntü üzerindeki belirli spektral bantlarda bulunan özellikler de spektral özellikler denir. Bu özellikler tamamı bir hastanın tıbbi görüntüsünden çıkarılan bilgileri temsil eder. Radyomik analiz, bu özelliklerin genetik, moleküler veya klinik verilerle birleştirilmesini içerir ve bu da hastalıkların tanı, tedavi ve prognozunu anlamak için kapsamlı bir bilgi sağlar (Tomaszewski & Gillies, 2021).

Radyomik veriler, tıbbi görüntülerin analizi yoluyla elde edilen özelliklerdir ve çeşitli amaçlarla kullanılmaktadır. Radyomik verilerin kullanım alanları ve amaçları hastalık tanısı, tedavi planlama, tedavi yanıtı ve prognoz tahmini, hastalık izleme ve gerileme takibi, biomarker geliştirme, klinik araştırmalar olarak sıralanabilir (Kumar et al., 2012).

## MATERYAL VE METOT

### 1. Veriseti

Kanser alanında yapılan çalışmalarda farklı organlardaki farklı türlerdeki kanser çeşitleri için çok sayıda veri seti bulunmaktadır. Bu veri setleri, kanserle ilgili genetik, moleküler, klinik ve görüntüleme verilerini içerebilir. Alanda en kapsamlı veri setlerini bulunduran kaynaklar “National Cancer Institute” (National Cancer Institute, 2023) ve “Cancer Imaging Archive” (Cancer Imaging Archive, 2023) (Şekil 1) kaynaklarıdır. Bu kaynaklarda bir kanser türüne ait farklı veri tiplerini içeren veri setleri bulunmaktadır. Ayrıca kanser ile ilgili olan veri setlerinin bazıları sınırlı erişim ya da kapalı olarak bulunmaktadır. Bu kaynaklarda veri setlerinden bazıları açık olarak paylaşılmaktadır.

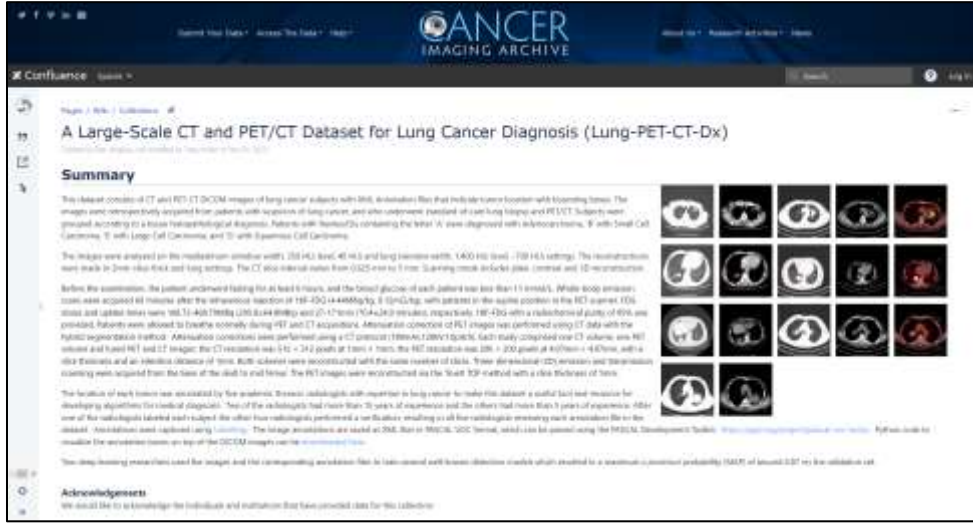

**Şekil 1.** Cancer Imaging Archive veriseti web sayfası görseli

“A Large-Scale CT and PET/CT Dataset for Lung Cancer Diagnosis (Lung-PET-CT-Dx)” (A Large-Scale CT and PET/CT Dataset for Lung Cancer Diagnosis (Lung-PET-CT-Dx), 2023) isimli veri seti radyomik verilerin oluşturulması için bu çalışma kapsamında kullanılmıştır. Bu veri seti 4 farklı kanser türüne ait akciğer kanserli hastaların CT ve PET-CT DICOM görüntülerini içermektedir (Tablo 1).

**Tablo 1.** Veri seti içeriği

Dosya isimleri	Kanser türü	Veri setine ait örnek görüntü
Lung_Dx-A0001	Adenokarsinom	
Lung_Dx-B0001	Küçük hücreli karsinom	
Lung_Dx-E0001	Büyük hücreli karsinom	
Lung_Dx-G0001	Skvamöz hücreli karsinom	



## 2. Kullanılan Araçlar

Medikal görüntülerdeki radyomik verileri çıkarabilmek için çeşitli yazılımlar, kütüphaneler ve uygulamalar bulunmaktadır. PyRadiomics, 3D Slicer, Radiomics Toolbox, CERR (Computational Environment for Radiotherapy Research), ve IBEX (Imaging Biomarker Explorer) alanda yaygın olarak kullanılan radyomik çıkarma araçlarıdır.

PyRadiomics, python tabanlı bir radyomik özellik çıkarma kütüphanesidir. DICOM (Dijital Görüntüleme ve İletişim) formatındaki medikal görüntülerden çeşitli radyomik özellikleri çıkarmak için kullanılmaktadır (Artificial Intelligence in Medicine (AIM) Program, 2023).

3D Slicer, görüntüleme ve radyomik analiz işlemleri için tasarlanmış açık kaynaklı bir yazılımdır. 3D Slicer, medikal görüntülerden çeşitli özellikleri çıkarmak ve analiz etmek için kullanılmaktadır (3D Slicer, 2023).

Radiomics Toolbox, MATLAB tabanlı bir araçtır ve radyomik özelliklerin çıkarılması ve analizi için çeşitli işlemlere sahiptir. Bu araç, medikal görüntülerden çeşitli radyomik özellikleri elde etmek ve analiz etmek amacıyla kullanılmaktadır (Radiomics.bio, 2023).

CERR, radyoterapi araştırmaları için tasarlanmış bir MATLAB tabanlı bir platformdur. Radyomik analizler için de kullanılabilir ve medikal görüntülerden özellik çıkarmak için çeşitli araçlar içermektedir (CERR, 2023).

IBEX, radyomik analiz ve görüntüleme biomarker'ları geliştirmek için tasarlanmış bir açık kaynaklı platformdur (Team, 2023).

Bu araçlar, radyomik analizlerde kullanılan yaygın ve güçlü çözümlerden sadece birkaçıdır. Radyomik çalışma alanı hızla gelişmektedir ve her geçen gün yeni araçlar, güncellemeler ortaya çıkmaktadır. Yapılması hedeflenen çalışma veya araştırma alanına uygun araçların seçilmesi önemlidir.

## 3. Yöntem

Bu çalışma kapsamında DICOM uzantılı verilerden radyomik özelliklerin çıkartılması için **Chia-Feng Lu tarafından geliştirilen MRP yazılımı kullanılmıştır (Lu, 2023). Bu yazılım verilen medikal görüntüleri okumakta ve bu görüntülerden radyomik özellikleri vermektedir. Bu işlem her bir medikal resim için tekrarlanmıştır.**

**Bu radyomik özellikler:** Energy, Entropy, Kurtosis, Maximum, Mean, Mean absolute deviation, Median, Minimum, Range, Root mean square, Skewness, Standard deviation, Uniformity, Variance, First quartile, Third quartile, Autocorrelation, Cluster Prominence, Cluster Shade, Cluster Tendency, Contrast, Correlation, Difference entropy, Dissimilarity, Energy, Entropy, Homogeneity 1, Homogeneity 2, Informational measure of correlation 1 (IMC1), Informational measure of correlation 2 (IMC2), Inverse Difference Moment Normalized (IDMN), Inverse



Difference Normalized (IDN), Inverse variance, Maximum Probability, Sum Average, Sum entropy, Sum variance, Variance, Short Run Emphasis (SRE), Long Run Emphasis (LRE), Gray-Level Nonuniformity (GLN), Run Length Nonuniformity (RLN), Run Percentage (RP), Low Gray-Level Run Emphasis (LGLRE), High Gray-Level Run Emphasis (HGLRE), Short Run Low Gray-Level Emphasis (SRLGLE), Short Run High Gray-Level Emphasis (SRHGLE), Long Run Low Gray-Level Emphasis (LRLGLE), Long Run High Gray-Level Emphasis (LRHGLE) şeklinde sıralanmaktadır.



Şekil 2. Uygulama sırasında MRP yazılım arayüzü

Bu arayüz kullanılarak akciğer kanserine ait medikal resimlerin radyomik özellikleri çıkartılmıştır. Elde edilen radyomik özelliklere Şekil 3'te yer verilmiştir.

First order statistic			
1. Energy:	2482665276.	27. Contrast:	0.16875
2. Entropy:	8.835	28. Correlation:	0.01352
3. Kurtosis:	14.083	29. Difference entropy:	0.51388
4. Maximum:	1623.2323	30. Dissimilarity:	0.11024
5. Mean:	839.068	31. Energy:	0.60517
6. Mean absolute deviation:	61.089	32. Entropy:	1.5509
7. Median:	803.9393	33. Homogeneity 1:	0.95024
8. Minimum:	779.0104	34. Homogeneity 2:	0.96881
9. Range:	844.2219	35. Informational measure of correlation 1:	-0.00803
10. Root mean square:	845.0542	36. Informational measure of correlation 2:	0.86184
11. Skewness:	3.5084	37. Inverse Difference Moment Normalized:	0.0079
12. Standard deviation:	100.8074	38. Inverse Difference Normalized:	0.98815
13. Uniformity:	0.016203	39. Inverse variance:	0.88502
14. Variance:	10182.3112	40. Maximum Probability:	0.77242
7-1. First Percentile:	794.2395	41. Sum Average:	2.7724
7-3. Third Percentile:	820.5993	42. Sum entropy:	1.408
Shape/size based features			
15. Compactness 1:	0.0038889	43. Sum variance:	3.2655
16. Compactness 2:	0.0047618	44. Variance:	0.00857
17. Maximum 3D diameter:	432.743	Gray level run-length matrix	
18. Spherical dispersion:	5.944	45. Short Run Emphasis:	0.01888
19. Sphericity:	0.10824	46. Long Run Emphasis:	50.6413
20. Surface area:	71354.2637	47. Gray-Level Nonuniformity:	24681.8688
21. Surface to volume ratio:	0.57894	48. Run Length Nonuniformity:	24435.7134
22. Volume:	123876.7047	49. Run Percentage:	0.73831
Textural features			
Gray level co-occurrence			
23. Autocorrelation:	2.7008	50. Low Gray-Level Run Emphasis:	1.2337
24. Cluster Prominence:	149.8142	51. High Gray-Level Run Emphasis:	143.2126
25. Cluster Shade:	18.3272	52. Short Run Low Gray-Level Emphasis:	0.83085
26. Cluster Tendency:	3.2850	53. Short Run High Gray-Level Emphasis:	3.0008
		54. Long Run Low Gray-Level Emphasis:	48.3062
		55. Long Run High Gray-Level Emphasis:	69.0438

Şekil 3. MRP yazılım arayüzü üzerinden elde edilen değerler

Elde edilen bu radyomik özellikler kanser türleri hakkında yorum yapmak amacıyla kullanılacaktır. Hedeflenen çalışma iş akışı Şekil 4'te verilmiştir. Radyomik verilerin derin öğrenme yöntemi ile analizi hedeflenmektedir.

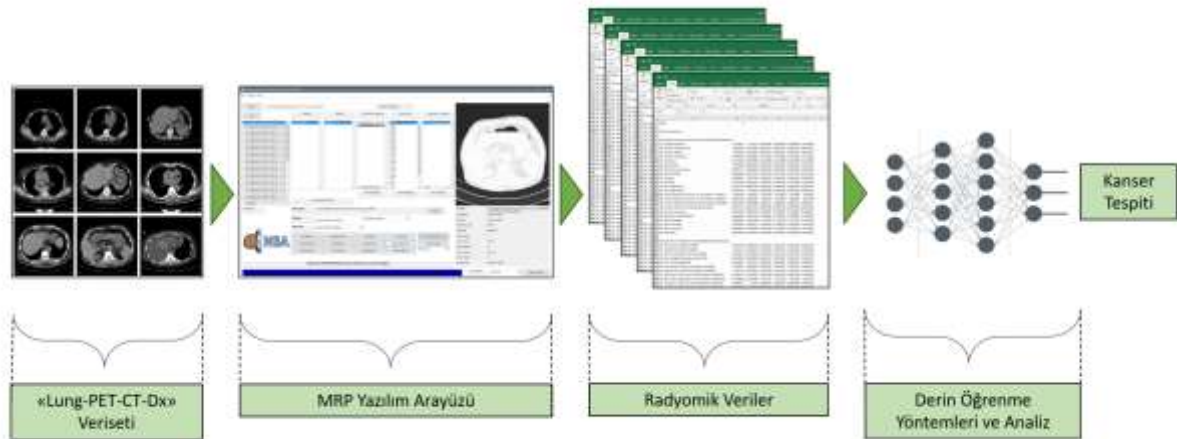

Şekil 4. Hedeflenen çalışma iş akışı



## SONUÇ ve TARTIŞMA

Radyomik özelliklerin çıkarılmasının temel amacı, tıbbi görüntülerden elde edilen bilgileri daha derinlemesine analiz ederek hastalıkların anlaşılmasını, teşhisini, tedavi planlamasını ve prognozunu iyileştirmektir. Farklı tıbbi merkezlerden elde edilen görüntülerin ve verilerin entegrasyonu ve standartlaştırılması, radyomik analizin daha güvenilir ve genelleştirilebilir hale getirilmesine yardımcı olacaktır. Derin öğrenme yöntemlerinin radyomik analizde daha fazla kullanımı, karmaşık ilişkileri tanımlama ve hastalık belirtilerini daha hassas bir şekilde sınıflandırma yeteneğini artırabilir. Birden fazla görüntüleme modalitesinin (örneğin, CT, MRI, PET) bir araya getirilerek analiz edilmesi, daha kapsamlı ve bütünsel bir hastalık profili oluşturulmasına olanak sağlar. Radyomik analizlerde kullanılan veri setlerinin büyüklüğü ve karmaşıklığı, büyük veri ve veri madenciliği yöntemlerinin daha fazla uygulanmasını gerektirebilir. Radyomik özelliklerin daha yüksek hassasiyet ve özgüllük sağlamak üzere iyileştirilmesi, klinik uygulamalarda daha güvenilir sonuçlar elde etmeyi mümkün kılabilir. Radyomik analiz, hastaların genetik, moleküler ve klinik profilleri ile entegre edilerek daha bireyselleştirilmiş tıp uygulamalarının geliştirilmesine olanak tanır. Radyomik analizlerin kanserlerin yanı sıra diğer hastalıklarda da uygulanabilirliğini değerlendiren çalışmalar, bu alandaki genişletilmiş uygulama potansiyelini ortaya çıkarabilir. Radyomik özelliklerin klinik pratiğe daha fazla entegre edilmesi ve bu özelliklerin klinik validasyon çalışmaları, radyomik analizin hastaların bakımında daha sık kullanılmasını sağlayabilir. Radyomik, hastalıkların altında yatan etiyolojik ve biyolojik süreçleri anlamak için daha fazla araştırmaya olanak tanıyabilir. Bu alanlarda gerçekleşecek ilerlemeler, radyomik analizlerin tıp pratiğinde daha yaygın bir şekilde kullanılmasını sağlayabilir ve hastalıkların daha etkili bir şekilde anlaşılmasına, tanılanmasına ve tedavi edilmesine katkıda bulunabilir.

## Referanslar

3D Slicer, 3D Slicer image computing platform, Erişim Adresi: <https://www.slicer.org/>, Erişim Tarihi: 09.12.2023

A Large-Scale CT and PET/CT Dataset for Lung Cancer Diagnosis (Lung-PET-CT-Dx), Erişim Adresi:

<https://wiki.cancerimagingarchive.net/pages/viewpage.action?pageId=70224216>,

Erişim Tarihi: 09.12.2023

Artificial Intelligence in Medicine (AIM) Program, PyRadiomics, Erişim Adresi: <https://github.com/AIM-Harvard/pyradiomics>, Erişim Tarihi: 09.12.2023

Cancer Imaging Archive, Erişim Adresi: <https://www.cancerimagingarchive.net/collections/>, Erişim Tarihi: 09.12.2023



- CERR, A Computational Environment for Radiological Research, Erişim Adresi: <https://cerr.github.io/CERR/>, Erişim Tarihi: 09.12.2023
- Kumar, V., Gu, Y., Basu, S., Berglund, A., Eschrich, S. A., Schabath, M. B., . . . Fenstermacher, D. J. M. r. i. (2012). Radiomics: the process and the challenges. *30*(9), 1234-1248.
- Lee, G., Lee, H. Y., Park, H., Schiebler, M. L., van Beek, E. J., Ohno, Y., . . . Leung, A. J. E. j. o. r. (2017). Radiomics and its emerging role in lung cancer research, imaging biomarkers and clinical management: State of the art. *86*, 297-307.
- Lu, C.-F, Multimodal Radiomics Platform, MRP V5.0. Erişim Adresi: [http://cflu.lab.nycu.edu.tw/MRP\\_MLinglioma.html](http://cflu.lab.nycu.edu.tw/MRP_MLinglioma.html), Erişim Tarihi: 09.12.2023
- National Cancer Institute, Erişim Adresi: <https://portal.gdc.cancer.gov/>, Erişim Tarihi: 09.12.2023
- Pichler, B. J., Judenhofer, M. S., & Pfannenbergl, C. J. M. I. I. (2008). Multimodal imaging approaches: Pet/ct and pet/mri. 109-132.
- Radiomics.bio, RadiomiX Toolbox. Erişim Adresi: <https://radiomics.bio/radiomix-toolbox/>, Erişim Tarihi: 09.12.2023
- Team, I. , IBEX. Erişim Adresi: <https://github.com/ibex-team/ibex-lib>, Erişim Tarihi: 09.12.2023
- Tomaszewski, M. R., & Gillies, R. J. J. R. (2021). The biological meaning of radiomic features. *298*(3), 505-516.
- Van Timmeren, J. E., Cester, D., Tanadini-Lang, S., Alkadhi, H., & Baessler, B. J. I. i. i. (2020). Radiomics in medical imaging—“how-to” guide and critical reflection. *11*(1), 1-16.



## ANTIOXIDANT, ENZYME INHIBITION AND TOXICOLOGY STUDIES OF METHANOL EXTRACTS OF SELECTED MEDICINAL PLANTS

Hiba SHAHID

Prof. Dr. Syed Ali Raza NAQVI

Research Laboratories of Chemistry Department, Government College University Faisalabad,  
Pakistan.

### ABSTRACT

The purpose of this work was to study the biological activities of methanolic extracts of *Tagetes erecta*, *Calendula officinalis* and *Murraya koenigii* on alpha-amylase at varying concentrations. Antioxidants obtained from selected medicinal plant extracts should be able to produce the desired redox reaction, be physiologically inert, non-toxic, effective in low concentrations, and should provide prolonged stability to the formulation. The comet assay's detection of DNA damage highly depends on the cells in the selected therapeutic plant components. Environmental pollution is a major factor that has an impact on human lives as it damages cell DNA. The % radical scavenging activity was performed by using DPPH and FRAP antioxidant assays. The % inhibition of methanolic extracts were performed by using  $\alpha$ -amylase and urease inhibition assays. The toxicology studies were performed by using comet assay to check the selected plants extract's potential to damage DNA. The % inhibition of methanolic extracts of alpha amylase was noted in the range of 11.49 to 50.56 % and  $IC_{50}$  in the range of  $04.09 \pm 0.05$  to  $07.39 \pm 0.23$   $\mu\text{g}/\text{mL}$  respectively at the mentioned concentrations. The % urease inhibition range of leaf extracts at 300 to 400 rpm of *Tagetes erecta* were in range of 52.32 to 2.11 %. Methanolic extracts of *Tagetes erecta* showed the total phenolic contents in the range of  $0.03 \pm 0.24$  to  $0.42 \pm 0.63$  mg GA/ 100g for leaf extracts and  $0.006 \pm 0.39$  to  $0.09 \pm 0.28$  mg GA/100g for stem extracts.  $0.02 \pm 0.32$  to  $0.17 \pm 0.38$  mg GA/ 100g TPC of curry leaves and  $0.02 \pm 0.32$  to  $0.17 \pm 0.38$  mg GA/ 100g,  $0.001 \pm 0.39$  to  $0.18 \pm 0.39$  mg GA/100g for leaf and stem extracts of *Calendula officinalis*. According to researchers, the total phenolic contents in a plant largely contribute to antioxidant activity. The % radical scavenging activity of leaf extracts of *Tagetes erecta* was noted in the range of 2.13 to 76.13 % and 3.73 to 46.31 % by using DPPH and FRAP antioxidant assays. The current experiment showed that NDEA increased DNA damage, as indicated by the lengthening of the comet tail.



ATLAS 11. INTERNATIONAL  
CONGRESS ON ADVANCED SCIENTIFIC STUDIES AND INTERDISCIPLINARY RESEARCH

---

Ingestion of *T. erecta* leaf extract significantly reduced protein and lipid oxidation and lessened DNA damage, which is interpretable as a decrease in oxidative stress brought on by NDEA. The results of the work therefore, clearly indicate the potential of these extracts to manage hyperglycemia and oxidative stress. The evaluation of enzyme inhibition and antioxidant potentials of plant extracts has been done by using 96-well microplate reader technique. Data obtained has been statistically analyzed using appropriate statistical tools.

**Keywords:** *Tagetes erecta*, *Calendula officinalis*, *Murraya koenigii*, antioxidant, enzyme inhibition, comet assay, evaluation and statistical analysis.



## ROLE OF NANOROBOTICS IN HEALTHCARE

Priyanshi Goyal

School of Pharmacy, Mangalayatan University, Aligarh, Uttar Pradesh, India

Priyanshi goyal, School of Pharmacy, Mangalayatan University, Aligarh, Uttar Pradesh, India

### ABSTRACT

The term "nano-robot" refers to any kind of controllable machine that is built from nano-components and operates on the nano ( $10^{-9}$ ) metre or molecular size. Specifically, nano robotics is the field of nanotechnology engineering that focuses on the design and construction of these still-largely-speculative machines. Nanorobotics and macrorobotics are quite different fields owing to scale and material variations, yet there are many shared design and control techniques that could be applied in the future. Thanks to today's scientific know-how, we can try to build nanorobotic devices and link them to the macro world for control. There is a chance to construct more of these devices by emulating nature, and there are innumerable examples in nature. Nowadays these nano robots play a vital role in the field of Bio Medicine. This paper guides to the recent research on nano robots in the Bio medical applications with their composition.

**Keywords:** Nanorobots; healthcare; biomedicine; cancer; diabetes



## BIOENERGY – ITS PRESENT AND FUTURE DUTY IN THE RENEWABLE ENERGY SYSTEM

\*<sup>1</sup>Iirjan Malollari, <sup>1</sup>Hasime Manaj, <sup>2</sup>Sami Makolli, <sup>1</sup>Anisa Dhroso

<sup>1</sup>Chemical Process Engineering Group, Department of Industrial Chemistry, University of Tirana

\*Renewable Energy Unit, Academy of Sciences of Albania

<sup>2</sup>UBT- University for business and Technology, Prishtinë, Kosova

### ABSTRACT

Suppose current generations continue to extract and consume fossil energy resources at today's rates. In that case, the most significant risk, in the short or medium term, in addition to the depletion of such resources, will be irreversible damage to today's and future environment. The use of fossil resources, formed over millions of years, has allowed the achievement of an unparalleled way of life. Industry, trade and services have developed thanks to machines powered by the energy produced by such fuels. Energy crises will also increase "polluting" fossil fuels such as carbon, bituminous sands and fuel oils due to increasing CO<sub>2</sub> emissions in the atmosphere. In consideration of this flow of the problem, many countries and international organizations have tried in recent years to search for suitable instruments to adapt Development to preserve the environment [1-3].

One of the instruments available to achieve this objective is the ever-more frequent use of renewable energy sources, mainly through biomass, wind, solar, water and geothermal energy, which can guarantee an environmental impact smaller than that produced from natural fossil resources. In this framework, a more fruitful contribution is required for the Identification and evaluation of these current resources of the country with renewable origin, as well as bringing to life efficient modern methods for the development of new technological and engineering processes suitable for the conditions of the country, which lead in a tendentious manner towards the optimal use of alternative energy sources.

Nature develops, perfects and balances its resources, becoming an inexhaustible energy source only through cycles and recycling. Implementing strategies to combat the consequences of the rapid use of fossil fuels as the primary energy source is essential. In addition to a method for energy conservation and reduction of energy consumption accompanied by increased efforts for an intelligent system of transmission and distribution of the produced energy, using renewable energy sources is the most logical solution to this problem.

**Keywords:** renewable energy, organic resources, advantages, technologies, social impact, environment protection





## SIMULATION OF POLYLACTIC ACID AND XYLITOL PRODUCTION FROM THE BREWER'S SPENT GRAINS

<sup>1</sup>Iirjan Malollari, <sup>2</sup>Redi Buzo, <sup>1</sup>Luljeta Pinguli, <sup>1</sup>Fjora Cane

<sup>1</sup>Chemical Process Engineering Group, Department of Industrial Chemistry, University of Tirana

<sup>2</sup> Department of Bio Chemistry, University “Fan S. Noli”, Korçë, Albania

### ABSTRACT

Brewer's spent *grains* (BSG) are a valuable by-product of brewing technology. They constitute a solid residue from malt production as the grain material is soaked in water, broken up and dried. The scraps are collected at the end during the shredding process. Brewer's spent *grains* are generally composed of lignin, cellulose, hemicellulose, and protein, although their different composition depends on the type of grain used, processing conditions, and storage methods. Brats can make up 85% of the total product of the brewing process and are widely used for livestock feed due to their high fibre and protein content. Generally, the spent grain is given to local farms at a low price to ensure it can be removed from the plant before degradation. In general, many breweries consider spent grain material to be heavy.

Bioethanol, Polylactic Acid and Xylitol production from grain grains used by breweries through our study was determined and analysed for their economic viability. The following processes were created by scaling up laboratory processes in the scientific literature and evaluating patent literature from major chemical companies. The bioethanol production process is the simplest of the three estimated fermentation processes of grain grains (wheat, corn, barley, rye, etc.).

With this study, we seek to present a process for converting waste into two products with added value, such as an alternative diabetic sugar called xylitol, and a biodegradable polymer material, such as polylactic acid. This process uses beer from breweries and minibreweries as raw material. The process consists of collection, universal pre-treatment and then a separation process to feed one of two continuous fermenters. A large amount of acidophilic yeast *Candida tropicalis* ferments xylose to xylitol, then purifies it to a marketable form. *Lactobacillus delbrueckii*, this type of bacteria, ferments glucose into lactic acid, which then polymerises to form polyacetic acid. This polymer is then cleaned (purified) and processed for sale. The product profile is optimal as it includes both the main components of the grain, cellulose and hemicellulose. Under current market conditions, this process is expected to be financially desirable.

**Keywords:** Brewer's spent *grains*, Bioethanol, Polylactic Acid, Xylitol



## DESIGN NOVEL ANTICANCER AGENTS FOR HUMAN BREAST CANCER CELL LINE: EXPLORING VIA QSAR AND MOLECULAR DOCKING ANALYSES

**Khaoula Mkhayar<sup>1,\*</sup>, Kaouakeb El khattabi<sup>2</sup>, Samir Chtita<sup>3</sup> and Souad Elkhattabi<sup>1\*</sup>**

<sup>1</sup> Laboratory of Engineering, Systems and Applications, National School of Applied Sciences, Sidi Mohamed Ben Abdellah-Fez University, Fez, Morocco.

<sup>2</sup> Department of Fundamental Sciences, Faculty of Medicine Dentistry, Mohammed V University, Rabat, Morocco.

<sup>3</sup> Laboratory of Analytical and Molecular Chemistry, Faculty of Sciences Ben M'Sik, Hassan II University of Casablanca, B.P 7955, Casablanca, Morocco

### ABSTRACT

In this study, we explored the quantitative correlation between the anti-NSCLC (Non-Small Cell Lung Cancer) biological activity and the molecular structure within a series of 38 derivatives of cyclohexane-1,3-dione-dimidone. To achieve this, we utilized molecular descriptors computed through DFT-B3LYP/6-31G, along with topological and physicochemical analysis. The outcomes of the QSAR models developed herein using MLR and MNLN techniques exhibit the robust predictive capability of these models. Specifically, the linear model yielded an  $R^2$  value of 0.913 ( $R^2_{CV} = 0.85$ ,  $R^2_{test} = 0.934$ ), while the nonlinear model achieved  $R^2$  values of 0.991 ( $R^2_{CV} = 0.82$ ,  $R^2_{test} = 0.997$ ). Leveraging the predictions derived from the QSAR model, novel molecular structures were designed and subsequently assessed for their anti-NSCLC activity. Furthermore, significant interactions between these molecules and the human c-Met protein were forecasted. Integrating projections from the QSAR models, molecular docking analyses, and in silico ADMET property evaluations, we pinpointed one out of the 16 newly developed molecules as a potential drug candidate for NSCLC.

**Keywords:** QSAR, ADMET, Molecular Docking, NSCLC, C-met



## **TOTAL FACTOR PRODUCTIVITY (TFP) OF THE INDONESIAN MANUFACTURING INDUSTRY USING LEVINSHON-PETRIN APPROACH**

**Hertiana Ikasari**

Dian Nuswantoro and Diponegoro University, Semarang, Indonesia

**FX. Sugiyanto**

Diponegoro University

**Akhmad Syakir Kurnia**

Diponegoro University

### **ABSTRACT**

The aim of this research is to analyze the productivity of medium and large businesses in the Indonesian manufacturing industry in 2010-2019. The production function is estimated using the Levinshon-Petrin (L-P) approach. The dependent variable used is value added, while the independent variable is labor and capital expenditure which is proxied using the value of purchases/additions and manufacture/repairs of fixed capital goods. In addition, the L-P approach uses intermediate inputs as a proxy for unobservable productivity shock. This research uses secondary data from the Indonesian Central Statistics Agency using the 4-digit standard classification of Indonesian business field. The number of industries studied was 1771 industries, excluding industry codes 1420, 2621, 2818, 2823, 3040, 3320, due to unavailability of data. This result demonstrates that medium and large businesses exhibit decreasing returns to scale

**Keywords:** Total Factor Productivity; Levinshon-Petrin; Manufacturing Industry; medium and large business



**THE ROLE OF TOURISM ADVERTISING  
IN THE PROMOTION OF TOURISM SECTOR  
APPLIED STUDY ON THE LIBYAN TOURISM MINISTRY**

**Arwa Abdul Magid Mohamed Elmahjubi**

Tourism Studies Department, Faculty of Arts, Tripoli University – Libya

**ABSTRACT**

The study objective was to identify the role of advertising in the promotion of tourism sector. The study adopted the descriptive research method to describe the role of advertising and its functions, characteristics and tools in promoting the tourism sector through the collection of data and information required. The collection of data and information has been done through distributing questionnaires were directed to intentionally sample, who work in the promotion and advertising department. The targeted were (26) people. The collected questionnaires were evacuated and analyzed and hypothesis were tested by using the statistical package for social sciences (SPSS). The hypothesis were positively proven which indicated that: There is statistical relationship between advertising and the promotion of tourism sector in Libya. The study reached a number of results and recommendations, the most important of them: there were statistical relationship between advertising and tourism promotion. The correlation coefficient scored (0.803) which resulted in advertising do promote the tourism sector in Libya by (64.3%). The most important recommendation was to increase the allocated budget for advertising to guarantee its effectiveness and sufficiency and to select the most appropriate promotional tools to sustain the promotional campaigns.

**Keywords:** Tourism advertising, tourism sector in Libya, Libyan Tourism Ministry, advertising department, promotion department.



## دور الاعلان السياحي في تنشيط قطاع السياحة دراسة تطبيقية على ديوان وزارة السياحة الليبية

أ. أروى عبدالمجيد محمد المحجوب  
قسم الدراسات السياحية، كلية الآداب، جامعة طرابلس، ليبيا

### المستخلص:

هدفت الدراسة إلى التعرف على دور الاعلان السياحي في تنشيط قطاع السياحة. واعتمدت هذه الدراسة على المنهج الوصفي لوصف دور الاعلان ووظائفه، وخصائصه، ووسائل الاعلان في تنشيط قطاع السياحة من خلال جمع المعلومات والبيانات المطلوبة وذلك بموجب توزيع أسئلة استبيان تم توزيعها على عينة قصدية قوامها (26) مفردة ممتثلة في العاملين بإدارتي التنشيط والاعلام السياحي بديوان وزارة السياحة الليبية. وتم تحليل عرض بيانات الدراسة والإجابة عن أسئلتها واختبار فرضياتها من خلال تطبيق الحزمة الاحصائية للعلوم الاجتماعية (SPSS)، حيث تم اثبات الفرضية التي تنص على وجود دور ذو علاقة احصائية بين الاعلان السياحي وتنشيط قطاع السياحة الليبي. وتوصلت الدراسة على عدد من النتائج والتوصيات من أهمها: وجود علاقة معنوية ذات دلالة إحصائية بين الاعلان وتنشيط قطاع السياحة، حيث بلغت قيمة معامل الارتباط (0.802) ونتج عنها أن الاعلان يعمل على تنشيط القطاع السياحي بنسبة بلغت (64.3%). وأهم التوصيات: الحرص على رفع الميزانية المخصصة للإعلانات لضمان كفايتها وكفاءتها لاختيار وسائل الاعلان المناسبة لدعم الحملات الاعلانية.

**الكلمات المفتاحية:** الاعلان السياحي، قطاع السياحة الليبي، وزارة السياحة، ادارة التنشيط السياحي، قسم الاعلام بوزارة السياحة.

### 1.1 مقدمة

يُعد الإعلان السياحي من أهم وسائل الترويج السياحي، لذا سنتطرق في هذا الورقة إلى تعريف الإعلان السياحي، خصائص الإعلان السياحي، وظائف الإعلان السياحي، بالإضافة إلى الوسائل الإعلان السياحي. حاول العديد من الباحثين والخبراء إعطاء صورة شاملة للإعلان من خلال عدد من التعاريف نذكر منها:  
يُعد الإعلان من عناصر المزيج الترويجي، ونشاط اتصالي غير شخصي لنقل المعلومات الخاصة بالمنتج أو الخدمة لغرض إقناع الزبون. والإعلان السياحي هو الدليل المادي للصناعة السياحية من خلال وظيفته الأساسية وجوهرها ، وهو يعرف بما تحتويه البلد من معالم سياحية سواء أكانت طبيعية أم أثرية تاريخية أم فندقية أو أي مظهر آخر أو مجال من مجالات الجذب السياحي ، وذلك باستخدام كافة الوسائل الإعلامية والاتصالية المتطورة من أفلام وإعلانات



قادرة على جذب السياح الأجانب ومواطني البلد، وبالتالي فالإعلان السياحي ضرورة حتمية ومحورية للصناعة السياحية.

### 2.1 تعريف الاعلان

عرفه الاتحاد الأمريكي للتسويق على انه : الشكل الغير الشخصي لتقديم وترويج الأفكار والخدمات بواسطة جهة معلومة مقابل اجر مدفوع (سالف، 2018).

كما عُرف الإعلان بأنه نشاط فيه فن وعلم لإغراء الأفراد والمستهلكين لشراء السلع والخدمات المعلن عنها عبر وسائل اتصال معينة، مقابل اجر مدفوع ( الحربي، 2012).

ويقصد بالإعلان السياحي انه" جهود غير شخصية ومدفوعة تعمل على التأثير في فئات المستهلكين وتوجيههم لشراء البرامج السياحية، ولنجاح الإعلان السياحي لابد لنا من دراسة رغبات وحاجات وأذواق السياح وأيضا العوامل الاجتماعية والجغرافية والاقتصادية بعدها يمكن وضع حملة إعلامية تجذب الكثير من السياح ( زعباط، 2018).

### 3.1 وظائف الإعلان السياحي

تتمثل وظائف الإعلان السياحي في(البكري، 2009)(الصيداوي، 2018):

- أن يعتمد على الحقائق و البيانات الصادقة المعبرة فعلا عن الخدمات التي ستقدمها شركة السياحة خلال البرنامج السياحي المعلن عنه بدون مبالغة.
- أن تعبر فعلا عن ما يتضمنه من( المحفزات السياحية ) وعناصر الجذب السياحي التي تجذب السياح، وتدفعهم إلى زيارة دولة معينة وتزيد من إنفاقهم.
- أن تكون رسالة متجانسة مع عادات وتقاليد وتاريخ وقيم، وعادات المجتمع الذي نخاطبه.
- إن الإعلان في الغالب يركز على المنطقة الرمادية في الدماغ، بقدر ما يعتمد على إثارة المشاعر، وتهيج النفوس لاستقطاب السائح لزيارة منطقة معينة.

### 4.1 وسائل الإعلان السياحي

من الوسائل المستخدمة في الإعلان السياحي ما يلي (احسان، 2017):

- **الوسائل الصوتية:** وهي الوسيلة التي تستخدم حاسة السمع لدى السياح وهي الندوات، والمؤتمرات والإذاعة المسموعة.
- **الوسائل المطبوعة:** وتتضمن جميع الوسائل المكتوبة، الصحف، والمجلات، والملصقات، واللافتات السياحية.
- **الوسائل المرئية:** وهي الوسيلة التي تستخدم حاسة النظر للسائح ومنها معارض السياحة، الإعلانات الضوئية، النماذج السياحية.



- الوسائل الصوتية والمرئية: وهي الوسيلة التي تستخدم حاسة النظر والسمع في آن واحد ومن هذه الوسائل التلفاز، والانترنت، والأفلام السينمائية.

### 5.1 الدراسة الميدانية

وقد استخدمت الباحثة الترميز الرقمي في ترميز إجابات أفراد المجتمع للإجابات المتعلقة بالمقياس الخماسي حيث تم إعطاء درجة واحدة للإجابة (غير موافق بشدة)، ودرجتان للإجابة (غير موافق) وثلاث درجات للإجابة (موافق إلى حد ما)، وأربع درجات للإجابة (موافق)، وخمس درجات للإجابة (موافق تماماً)، وقد تم تحديد درجة الموافقة لكل فقرة من فقرات الاستبيان ولكل محور من مقارنة قيمة متوسط الاستجابة المرجح مع طول فئة المقياس الثلاثي، وحسب طول فئة المقياس من خارج قسمة (2) على (3).

جدول (1) ترميز بدائل الإجابة وطول فئة تحديد اتجاه الإجابة

الإجابة	غير موافق بشدة	غير موافق	موافق إلى حد ما	موافق	موافق تماماً
الترميز	1	2	3	4	5
طول الفئة	1 إلى أقل من 1.8	1.8 إلى أقل من 2.6	2.6 إلى أقل من 3.4	3.4 إلى أقل من 4.2	4.2 إلى 5
درجة الموافقة	منخفضة جداً	منخفضة	متوسطة	مرتفعة	مرتفعة جداً

جدول (2) يوضح التوزيعات التكرارية ونتائج التحليل الوصفي لمتغير الدعاية والاعلان

ت	الفقرة	النسبة و التكرار	غير موافق بشدة	غير موافق	موافق إلى حد ما	موافق	موافق تماماً	المرجح المتوسط	الانحراف المعياري	درجة الموافقة
1	الميزانية المخصصة للإعلانات كافية.	ك %	11 42.3	2 7.7	4 15.4	9 34.6	0 0	2.42	1.362	منخفضة
2	يتم التخطيط للحملات الإعلانية.	ك %	0 0	0 0	10 38.5	9 34.6	7 26.9	3.88	0.816	مرتفعة
3	عدد الإعلانات كافي للتعريف بالسياحة في الأسواق الدولية.	ك %	6 23.1	6 23.1	4 15.4	10 38.5	0 0	2.69	1.225	متوسطة
4	عدد الإعلانات كافي للتعريف بالسياحة في السوق المحلي.	ك %	6 23.1	5 19.2	9 34.6	6 23.1	0 0	2.58	1.102	منخفضة
5	تصميم الرسالة الإعلانية مناسب لثقافة	ك	3	6	7	10	0	2.92	1.055	متوسطة



**ATLAS 11. INTERNATIONAL  
CONGRESS ON ADVANCED SCIENTIFIC STUDIES AND INTERDISCIPLINARY RESEARCH**

				0	38.5	26.9	23.1	11.5	%	المستهدفين من الإعلان.
مرتفعة	0.56	3.92	3	18	5	0	0	0	ك	تستخدم الإعلانات لتذكير السياح من فترة إلى أخرى بالموارد والخدمات السياحية.
			11.5	69.2	19.2	0	0	0	%	
مرتفعة	0.587	3.77	2	16	8	0	0	0	ك	التركيز على أسلوب الكلمة المنطوقة من خلال تحقيق رضا السياح عن الخدمات السياحية.
			7.7	61.5	30.8	0	0	0	%	
مرتفعة	0.599	3.96	4	17	5	0	0	0	ك	استخدام أكثر من وسيلة للإعلان عن الموارد والخدمات السياحية.
			15.4	65.4	19.2	0	0	0	%	
مرتفعة	0.724	3.73	2	17	5	2	0	0	ك	نشر الدعاية من خلال جهات محايدة حول الموارد والخدمات السياحية.
			7.7	65.4	19.2	7.7	0	0	%	
منخفضة	1.061	2.38	0	5	6	9	6	6	ك	أنا راضي عن عدد الإعلانات ووسائل الإعلام المستخدمة للإعلان عن الموارد والخدمات السياحية.
			0	19.2	23.1	34.6	23.1	23.1	%	
متوسط	0.59	3.23								إجمالي الاعلان

المصدر: الدراسة الميدانية

من الجدول رقم (2) تبين إن قيم المتوسطات لعبارات محور الاعلان، تراوحت ما بين (2.38) إلى (3.96)، كما تبين إن (5) عبارات كانت قيم متوسطاتها ضمن الفترة (3.4 إلى أقل من 4.2) وهذا يشير إلى إن درجة الموافقة على تلك العبارات كانت مرتفعة، وترتب تلك الفقرات تنازلياً كما يلي:

1. استخدام أكثر من وسيلة للإعلان عن الموارد والخدمات السياحية.
  2. تستخدم الإعلانات لتذكير السياح من فترة إلى أخرى بالموارد والخدمات السياحية.
  3. يتم التخطيط للحملات الإعلانية.
  4. التركيز على أسلوب الكلمة المنطوقة من خلال تحقيق رضا السياح عن الخدمات السياحية.
  5. نشر الدعاية من خلال جهات محايدة حول الموارد والخدمات السياحية.
- كما تبين إن عبارتين من عبارات هذا المحور كانت قيم متوسطاتها ضمن الفئة (2.6 إلى أقل من 3.4) لذا فإن درجة الموافقة على العبارتين كانت متوسطة، وترتبها تنازلياً كما يلي:

1. تصميم الرسالة الإعلانية مناسب لثقافة المستهدفين من الإعلان.
  2. عدد الإعلانات كافي للتعريف بالسياحة في الأسواق الدولية.
- وتبين أيضاً إن (3) عبارات من عبارات محور الدعاية والاعلان كانت قيم متوسطاتها تقع ضمن الفترة (1.8 إلى أقل من 2.6) لذا فإن درجة الموافقة على تلك العبارات كانت منخفضة وترتبها تنازلياً كما يلي:
1. عدد الإعلانات كافي للتعريف بالسياحة في السوق المحلي.
  2. الميزانية المخصصة للإعلانات كافية.
  3. أنا راضي عن عدد الإعلانات ووسائل الإعلام المستخدمة للإعلان عن الموارد والخدمات السياحية.





كما بينت النتائج في الجدول رقم (2) أن متوسط الاستجابة لإجمالي محورا الاعلان كان (3.23) ويقع ضمن الفئة (2.6 الى أقل من 3.4) لذا فإن مستوى الإعلان كان متوسطاً.

### 1.5.1 اختبار الفرضية

ركزت هذه الورقة على فرضية مفادها: يوجد أثر ذو دلالة إحصائية للإعلان السياحي على تنشيط قطاع السياحة الليلية.

جدول (3) نتائج تباين الانحدار لتحديد أثر للإعلان السياحي على تنشيط القطاع السياحي

معاملات الانحدار		قيمة الدلالة	نسبة الأثر	معامل التحديد (R <sup>2</sup> )	معامل الارتباط
الدعاية والاعلان	الثابت				
1.192	0.979-	0.000	%64.3	0.643	0.802

قيمة F المحسوبة = 43.258 درجات الحرية (1 ، 24) ، قيمة F الجدولية = 4.2597

المصدر: الدراسة الميدانية

أظهرت النتائج في الجدول (3) وجود علاقة معنوية ذات دلالة إحصائية بين الاعلان وتنشيط قطاع السياحة، حيث كانت قيمة معامل الارتباط (0.802)، وقيمة الدلالة الإحصائية تساوي صفرًا وهي أقل من 0.05 وتشير إلى معنوية العلاقة بين المتغيرين، أي إن الاهتمام بالإعلان يسهم في تنشيط قطاع السياحة في ليبيا. ولتحديد أثر الاعلان السياحي على تنشيط قطاع السياحة، فإن قيمة F تساوي (43.258) وهي قيمة مرتفعة قياساً بالقيمة الجدولية (4.2597)، وكانت قيمة الدلالة الإحصائية (P-Value) تساوي صفرًا وهي أقل من 0.05، وهذا يدل يؤكد القوة التفسيرية العالية لنموذج الانحدار الخطي من الناحية الإحصائية، وكانت قيمة معامل التحديد (0.643) وتدل على أن ما نسبته (%64.3) من التغيرات في تنشيط قطاع السياحة يعود إلى الاعلان ما لم يؤثر مؤثر آخر، لذا يتم قبول الفرضية الفرعية الأولى " يوجد أثر ذو دلالة إحصائية للإعلان السياحي على تنشيط قطاع السياحة الليلية ".

ويمكن تقدير معالم نموذج الانحدار حسب معادلة الانحدار بالشكل التالي:

$$Y = - 0.979 + 1.192 * X_1 + \varepsilon$$

حيث:

Y تنشيط القطاع السياحي ، X<sub>1</sub> الدعاية والاعلان، ε الخطأ العشوائي.

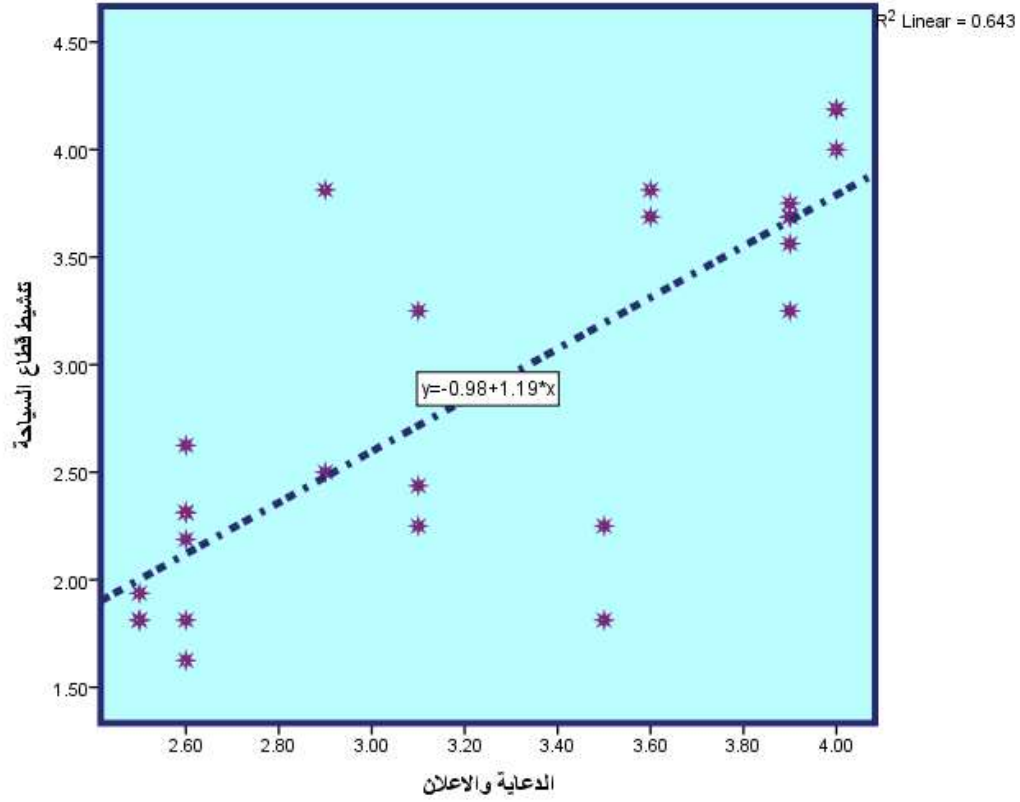

المصدر: الدراسة الميدانية  
شكل (1) يبين العلاقة بين الاعلان وتنشيط القطاع السياحي

## 6.1 النتائج والتوصيات

### أولاً: النتائج

خلصت الورقة على عدد من النتائج التالية:

1. بينت الدراسة وجود علاقة معنوية ذات دلالة إحصائية بين الاعلان وتنشيط قطاع السياحة، حيث بلغت قيمة معامل الارتباط (0.802) ونتج عنها أثر للإعلان على تنشيط القطاع السياحي بنسبة بلغت (64.3%).
2. أظهرت الدراسة إن مستوى الاعلان كان متوسطاً، فقد بلغت قيمة متوسط الاستجابة (3.23) وفق مقياس التدرج الخماسي.
3. أثبتت الدراسة أنه لا يوجد اهتمام كافي بالإعلانات للتعريف بالسياحة في السوق المحلي.
4. أظهرت الدراسة أن الميزانية المخصصة للإعلان عن النشاطات السياحية غير كافية.
5. بينت الدراسة أن الوسائل المستخدمة للإعلان عن الموارد والبرامج السياحية، والخدمات السياحية غير كافية.
6. عدم ملائمة عملية تصميم الرسالة الاعلانية للفئات المستهدفة من السياح.



### ثانياً: التوصيات

- بعد تحليل البيانات التي تم جمعها والوصول إلى استنتاجاتها، فإن الدراسة توصي بالآتي:
1. الحرص على رفع قيمة الميزانية المخصصة للإعلانات لضمان كفايتها وكفاءتها.
  2. تكثيف أعداد الإعلانات من خلال استخدام الوسيلة الاعلامية المناسبة للتعريف بالسياحة في الأسواق المحلية والدولية.
  3. الحرص على الاستغلال الأمثل للموارد السياحية لتنشيط القطاع السياحي في ليبيا.
  4. الأخذ بنظر الاعتبار ثقافات المستهدفين بالإعلانات عند تصميم الرسائل الإعلامية.
  5. إجراء دراسات ميدانية خارج ليبيا للتعرف على وجهات نظر السياح حول السياحة في ليبيا والأخذ بنظر الاعتبار نتائج وتوصيات تلك الدراسات.
  6. إقامة المؤتمرات العلمية وورش العمل لتقديم الدعم للشركات السياحية المحلية وقطاع السياحة بشكل عام.
  7. ضرورة جمع البيانات والمعلومات حول الأسواق والمستجدات في مجال السياحة بشكل دوري.
  8. استخدام الوسيلة الاعلامية التي تتوافق وثقافات السياح المحليين والدوليين.

### 7.1 المصادر

- إحسان سليمان سعد أحمد، (2017)، التسويق السياحي وأثره في أداء شركات ووكالات السياحة والسفر، دراسة ميدانية ولاية الخرطوم، أطروحة ماجستير في السياحة، جامعة شندي، السودان.
- البكري تامر، (2009)، الاتصالات التسويقية والترويج، الطبعة الثانية، دار الحامد للنشر والتوزيع، عمان، الاردن.
- زعباط سامي، (2018)، الترويج في المؤسسة الاقتصادية، ط(1)، مكتبة الوفاء القانونية للنشر، الاسكندرية، مصر.
- الصيداوي محمد سالف، (2018)، أثر عناصر المزيج الترويجي على السياحة الداخلية في دمشق وريف دمشق، أطروحة ماجستير في إدارة الاعمال، الجامعة الافتراضية السورية، سوري
- الحربي عباس رجا، (2012)، التسويق السياحي في المنشآت السياحية، دار أسامة للنشر والتوزيع، عمان، الاردن.



**NARCISSISTIC PERSONALITY DISORDER AND ITS TREATMENTS WITHIN  
THE FRAMEWORK OF PSYCHOTHERAPY APPROACHS**  
PSİKOTERAPİ EKOLLERİ ÇERÇEVESİNDE NARSİSİSTİK KİŞİLİK BOZUKLUĞU VE  
TEDAVİLERİ

**Dr. Ahmet ÖZBAY**

Milli Eğitim Bakanlığı, ORCID: 0000-0001-5021-5980

**Melis KARAKAŞ**

Yüksek lisans öğrencisi, İstanbul Aydın Üniversitesi, ORCID NO: 0009-0003-7653-2599

**ABSTRACT**

Narcissistic personality disorder receives its name from Narcissus, who (in Greek mythology) fell in love with his reflection in the water. Narcissism is intense self-love. These people talk excessively about themselves in social settings, despise individuals by displaying a grandiose attitude. They have a deep need for others however they are unable to express love. They lack empathy and are unable to maintain interpersonal relationships. Narcissistic personality disorder has been examined in various ways by many psychotherapy approaches and has been treated with several treatment techniques. These individuals may have this disorder due to the feeling of inferiority that they have experienced in the first period of their lives, their parents' upbringing style or the emotional deprivation that they experience. This study titled "narcissistic personality disorder and Its Treatments within the Framework of Psychotherapy Approaches" aims to reveal narcissistic personality disorder from the perspective of theories and theorists and to address which treatment methods are used to treat it by using the literature review method. Today, how to treat narcissistic personality disorder is a very controversial issue, so the study aims to contribute to the field by presenting the development of the narcissistic concept from the period when it first emerged to the present day and the treatment methods used as a whole.

**Keywords:** Narcissistic personality disorder, Psychodynamic psychotherapy, Cognitive behavioral therapy, Schema therapy, Masterson approach

**ÖZET**

Narsisistik kişilik bozukluğu adını Yunan mitolojisinde sudaki yansımasına âşık olan Narkissos'tan almaktadır. Narsisizm kişinin kendisine yoğun sevgi duymasıdır. Bu kişiler toplum içerisinde kendilerinden çokça bahsederler, büyüklenmeci bir tavır sergileyip karşılardaki bireyleri küçük görürler. Diğerlerine derin bir ihtiyaç duyarlar fakat sevgi gösteremezler. Empatiden yoksun ve kişiler arası ilişkileri sürdürmeyen bir yapıdadırlar. Narsisistik kişilik bozukluğu birçok psikoterapi ekolleri tarafından farklı şekillerde ele alınmakta ve farklı tedavi yöntemleri ile tedavi edilmektedir. Bu bireyler yaşamlarının ilk döneminde yaşadıkları aşağılık duygusundan, ebeveynlerinin yetiştirme stillerinden veya yaşadıkları duygusal yoksunluklardan dolayı bu bozukluğa sahip olabilmektedirler. "Psikoterapi Ekolleri Çerçevesinde Narsisistik Kişilik Bozukluğu ve Tedavileri" adlı bu



çalışmada literatür taraması yöntemi kullanılarak narsisistik kişilik bozukluğunun kuramlar ve kuramcılar perspektifinden ortaya konulmaya ve hangi tedavi yöntemleri ile tedavi edildiğini ele almayı amaçlamaktadır. Günümüzde narsisistik kişilik bozukluğunun ne şekilde tedavi edileceği çok tartışmalı bir konudur, bu sebeple çalışmada narsisistik kavramının ilk ortaya çıktığı dönemden günümüze kadar olan gelişimini ve kullanılan tedavi yöntemlerini bir bütün halinde sunarak alana katkı sağlanması amaçlanmıştır.

**Anahtar Kelimeler:** Narsisistik kişilik bozukluğu, Psikodinamik psikoterapi, Bilişsel davranışçı terapi, Şema terapi, Masterson yaklaşımı

## INTRODUCTION

"Narcissism" takes its name from Narcissus, a character in Greek mythology who fell in love with his reflection in the water. When Narcissus was born, his parents took him to a prophet, who said that if Narcissus never saw his reflection, he would live a long life. However, while hunting for one day, Narcissus stopped to drinking water from a pond and saw his own reflection, falling in love with it. Eventually, he became hopeless in his love and committed suicide (Öztürk, 2016). According to another myth, Narcissus was also a handsome young man loved by everyone, but he did not return any affection. This eventually caught the attention of the goddess aphrodites. Aphrodite cursed Narcissus, and as a result, he fell in love with his reflections while gazing at a pool of water. Narcissus spent every day alone with his own reflection, longing for the face that he could not possess. He was unaware that he was in love with his own image. Ultimately he tried to become one with the image and drowned in the pool (Millon et al, 2019: 439-440).

These two myths clearly illustrate the basis of narcissism, which is the intense love narcissists have for themselves. The term "narcissism" literally means "the love of one's own body," which implies a sexual desire and pleasure toward oneself (Özsaydın, 1984; cited in laraaziz & Erdem Atak, 2013: 46).

According to Masterson, narcissistic personality disorder is divided into three types. These are the exhibitionist narcissist, the covert narcissist and the devaluing narcissist. exhibitionist narcissistic individual, typically seeks perfection in everything they do, striving to achieve wealth, power, and beauty. They have endless motivation to find people who will admire them by reflecting their sense of grandiosity (Masterson, 2014).

Narcissism is generally categorized into two types. The first is DSM, which is a categorical approach used to obtain a more common result and diagnosis. The second is the dimensional approach, which evaluates the compatibility of general personality structures (Taymur & Türkçapar, 2012).

### *DSM-5 Diagnostic Criteria for Narcissistic Personality Disorder*

According to the Personality Disorders section of the American Psychiatric Association's Diagnostic and Statistical Manual of Mental Disorders, the diagnostic criteria for Narcissistic Personality Disorder are as follows:



1. Exaggerates achievements and talents are expected to be seen as superior based on these achievements and shows an unreasonable sense of entitlement.
  2. Engages in fantasies of unlimited success, power, intelligence, beauty, or ideal love.
  3. Believes that they are "special" and unique, and can only be understood by other special or high-status people (or institutions) and that they need to associate with them.
  4. Desires to be admired excessively.
  5. Feels entitled (especially have unrealistic expectations of receiving special treatment or getting what they want without earning it).
  6. Exploits others for their own gains (uses others to achieve their own goals).
  7. Lacks empathy: does not want to understand the feelings and needs of others.
  8. Often envies others or believes that others envy him/her.
  9. Shows arrogant behaviors or attitudes, and treats others disrespectfully
- (Köroğlu, 2014: 333-334).

### ***General Outlooks of Narcissistic Persons***

Narcissistic individuals tend to harm others through feelings of envy. They are critical by nature, and can be referred to as "self-loving subjects." Criticism, envy, and perfectionism prevail. They sustained their self-esteem by seeking approval from others. These individuals quickly notice similarities between themselves and others, and if they perceive a deficiency in themselves and see it in the other person, they begin to criticize and belittle them. They often create their identities based on being liked, supported, and deeply needing others, but their love is shallow (Kernberg, 2016).

Emotions in Reality  
feelings



Emotions that compensate for these difficult



(Hacak, 2023).



***Interpersonal Relationships in Narcissistic Personality Disorder***

Narcissists generally believe that they are entitled to everything and that they exhibit a lack of empathy. Therefore, it is difficult for them to form close relationships with each other. They are highly sensitive to harsh words and insults and often strive to create a small group of admirers who worship them. Usually, parents of narcissistic individuals idolized their children during infancy. Consequently, the child does not understand that others are separate individuals with their own desires. Parents do not accept that the child makes mistakes. If the child makes a mistake, they are no longer perfect or loved. From this, it can be said that the parents of these individuals are also narcissistic, and that narcissistic individuals enjoy talking about themselves and will immediately start talking about themselves if there is a crowd. They do not show any interest in others when they begin to speak, and usually interrupt and attempt to regain control of the conversation. Most narcissists have a fan base instead of close friends, and do not have their own thoughts. They generally adopt the thoughts of leaders and big men (Millon et al, 2019: 454-456).

***Types of Narcissistic Personality***

<p><b>UNPRINCIPLED</b> (Antisocial traits) They have a weak conscience; they are unprincipled, immoral, disloyal, deceitful, fraudulent, arrogant, exploitative; domineering, contemptuous, and vengeful.</p>	<p><b>ELITIST</b> (This is a derivative of the 'pure' pattern) Believes that their special status and supposed achievements in childhood give them privilege and authority; the image they project to the outside world has little to do with reality and they feel entitled to everything they display; they are seeking preferential treatment and a good life; they climb social ladders, establish relationships to gain a special place for themselves and to gain advantages.</p>
<p><b>LUSTFUL</b> (Histrionic traits) They are sexually seductive, inviting, and tempting; talkative and clever, but avoid real intimacy; they are prone to hedonistic desires and can charm and seduce helpless and naive people; they are pathological liars and deceivers.</p>	<p><b>COMPENSATORY</b> (Negative, Avoidant Traits) Tries to nullify or eliminate deep feelings of inferiority and lack of self-confidence; tries to compensate by creating an illusion that their flaws make them exceptional, admirable, and worthy of praise; their self-worth is dependent on how much they can improve themselves.</p>

(Millon et al, 2019: 435).

**Cognitive Behavioral Therapy**



The cognitive approach generally sees the individual not as a passive entity, but as an active being who perceives and interprets their environment (Cüceloğlu, 2012:28, cited in Yıldırım, 2020: 97-98). In the 1970s, the cognitive approach began to emerge, with Aaron T. Beck and Albert Ellis being its pioneers. As a psychotherapeutic approach, cognitive theory emphasizes that the problem of psychological disorders lies in cognitive functions. In general, cognitive interventions aim to reduce excessive emotional and rigid behavioral responses by regulating and changing individuals' thoughts, beliefs, and perception errors. Cognitive intervention aims to change an individual's thinking style towards events, oneself, and the environment (Hackney & Cormier, 2008: 177, cited in Yıldırım, 2020: 97-98). In the context of behavior, the focus is on trying to change the individual's behavior. As a result, both the cognitive and behavioral aspects aim to reduce or solve problems. The basic concepts in cognitive-behavioral therapy are cognition, automatic thoughts, beliefs, and core beliefs.

### ***Narcissistic Personality Disorder in Cognitive Behavioral Therapy***

Cognitive Behavioral Therapy defines narcissistic personality disorder as fragile self-esteem, a pursuit of attention and approval, and attempts to regulate them through explicit or implicit grandiose behaviors (Şalcıoğlu, 2022: 30). According to the behavioral model, there are no innate problems in individuals with any personality disorder. Individuals with narcissistic personality disorders have certain ingrained thoughts. These are highly dysfunctional thoughts. The treatment attempts to change these thoughts.

### ***“Established Thoughts of Narcissistic Personality Disorder” (Köroğlu, 2010).***

- I am very special.
- Because I am superior, I deserve special treatment and privileges.
- I do not need to follow the rules that others obey.
- I need to be recognized, praised, and admired.
- Those who do not show respect for their position must be punished.
- Other individuals should meet their needs.
- Others must understand how special I am.
- It is unforgivable to not receive respect or not get what I deserve.
- Others do not deserve admiration for what they have.
- Others do not have the right to criticize me.
- I am very special, and others must find new ways to replace me.
- Only superiors can understand me.
- I have many reasons to want great things.

### ***Dialectical Behavior Therapy***

Dialectical Behavior Therapy (DBT) is a type of cognitive behavioral therapy developed in the late 1980s by psychologist Marsha M. Linehan for the treatment of borderline personality disorder. It has also been used to treat other disorders. Therapy aims to develop skills in areas





such as mindfulness, emotion regulation, interpersonal effectiveness, and distress tolerance. There were four stages of therapy. The first stage focuses on reducing suicidal behaviors and addressing issues that negatively affect clients' quality of life. In the second stage, the client was encouraged to move from avoiding negative emotions to experiencing them. The third stage involved setting goals related to trauma, social issues, and life difficulties. Finally, the therapy aims to increase the client's capacity for freedom and enjoyment (Lynch, Trost, Salsman & Linehan, 2007; cited in Güzel, 2020: 593).

### ***Treatment of Narcissistic Personality Disorder in Cognitive Behavioral Therapy***

Goals generally include reducing behaviors such as comparative or exalting language, expecting special treatment or privileges, ignoring rules, thinking of rules are for others, and being excessively selective in friendships, while increasing behaviors such as empathy, perspective taking, and being open to criticism (Şalcıoğlu, 2022: 97). Social skills training, such as directing the person towards more functional behaviors in different environments, and communication skills training are treatment methods that can help a person establish more effective relationships. Patients with narcissistic personality disorder generally do not willingly receive therapy. Therefore, these goals must be clearly addressed. The person must be given empathy training, which includes teaching basic listening and attention skills. They were also taught and supported in the objective evaluation of others. Mirroring is important in therapy (Şalcıoğlu, 2022: 222-224).

Davis argued that narcissists' desire to be unique leads to many cognitive distortions. Narcissistic individuals tend to evaluate themselves and others in a black and white manner. They believe that they are superior to others, and that others should accept this. These thoughts should be replaced by more realistic thoughts. These types of thoughts not only boost a person's self-confidence but also eliminate sensitivity to failure. Davis also suggests that, instead of seeing themselves as superior to others, narcissistic individuals should seek personal similarities, which would be more empathetic. Role-playing techniques can be used to develop empathy (Millon et al, 2019: 474). Realistic goals and a realistic lives can be shown to a person. For example, a person can be a locally recognized actor instead of a globally recognized one. These realistic goals help the person look at life more objectively and become a helpful element in therapy.

To motivate the clients to stay in therapy for a certain period of time for a change, it may be necessary to show them enough attention and empathy. Talking about their successes in life and focusing on themselves can help alleviate depressive symptoms. However, if the therapist supports the person too much, the narcissistic individual may think that they do not need to change and become overly inflated (Millon et al, 2019: 473).

If the therapist uses sentences like "As you said before" to a client with narcissistic personality disorder, the patient may accept comments and suggestions more easily with the feeling of being listened to. Likewise, when the patient starts treatment, he/she may start with negative feelings towards the therapy and therapist, and the therapist must needs deal with



these negative feelings first. Otherwise, treatment may be threatened (Caligor, Levy & Yeomans, 2015).

***Schema Therapy***

Jeffrey et al. developed schema therapy by combining different therapeutic approaches to treat patients when cognitive behavioral therapy is insufficient. Schema therapy is more focused on the treatment of personality disorders, and its effectiveness has been proven in previous studies (Young, Klosko & Weishaar, 2022). Schemas refer to information that individuals learn after they are born. For example, a child's experience and knowledge about of approaches creates a schema for approaches. Therefore, individuals have millions of schemata. Schemas become certain patterns over time, and may become difficult to change. This is why real problems arise when the schemas cannot be changed. Schema therapy is a therapeutic technique that deals with negative schemas developed by individuals (Kaya, 2022).

SCHEMA AREAS	SCHEMATICS
Abandonment and Rejection	1- Abandonment/Instability 2- Mistrust/Abuse 3- Emotional Deprivation 4- Defectiveness/Shame 5- Social Isolation
Damaged autonomy and self-expression	6- Addiction/Inadequacy 7- Vulnerability to Illness and Harm 8- Enmeshment/Undeveloped Self 9- Failure
Impaired Boundaries	10- Entitlement / Grandiosity 11- Insufficient Self-Control / Self-Discipline
Other-Directedness	12- Submissiveness 13- Self Sacrifice 14- Approval-Seeking / Recognition-Seeking
Hypervigilance and Inhibition/Overcontrol	15- Negativity / Pessimism 16- Emotional Inhibition / Overcontrol 17- Overvigilance / Inhibition 18- Punitive / Cruelty

(Güler, 2020: 398)

**Şekil 1.** Young divided the scheme fields into five parts and collected the schemes under 18 headings.

***Schema Therapy for Narcissistic Personality Disorder***



Narcissistic Personality Disorder has three core modes in Schema Therapy:

- 1- Abandoned Child
- 2- Grandiose
- 3- Detached Self-Soother

Not all patients with narcissistic personality disorders have all of these modes. There were also patients in the different modes. Patients with narcissistic personality disorder are usually unable to give genuine love. The basic stages of narcissism are emotional deprivation and defectiveness, which are also a part of the Abandoned Child mode.

The entitlement schema is an overcompensation for the other two schemas, and is part of the grandiose mode. Most individuals with narcissistic personality disorders are unable to give genuine love. The core stages of narcissism are emotional deprivation and defectiveness, which are components of the abandoned child mode. They often act in a way that ensures that their needs are met, because they expect to be deprived. The primary reason they feel neglected and misunderstood is the schema.

A defectiveness schema is present because narcissists usually feel flawed. Consequently they avoid close relationships. They fundamentally want to connect with others, but feel uncomfortable and withdraw when they experience closeness (emotional deprivation = desire for closeness, defectiveness = withdrawal, distancing). They believed that any flaw they had would be humiliating and lead to rejection. When they fail to meet their high standards, they fall from a high place and experience shame. Such narcissistic injuries can lead to severe pathologies (e.g., depression and anxiety) (Young, Klosko & Weishaar, 2022: 534-535).

Other possible schemas in individuals with Narcissistic Personality Disorder include:

- Mistrust / Mistreatment
- Social Isolation
- Failure
- Insufficient Self-Control / Self-Discipline
- Submissiveness
- Approval-Seeking / Recognition-Seeking
- High Standards / Overcriticality
- Punitive / Cruelty.

### ***Treatment of Narcissistic Personality Disorder in Schema Therapy***

First, feelings of loneliness and shame should emerge to provide the patient with sufficient motivation for change (Dieckmann and Behary, 2015). The main goal of schema therapy is to replace automatic behavior with controlled behavior (Roediger, 2015: 91). For example, a narcissistic person may behave in an affirming manner instead of being dismissive, or engaging in acceptance behavior instead of longing. In the treatment of narcissism using schema therapy, the main goal is to help the patient develop a healthy adult mode. This involves helping the patient access their lonely child mode so that they can feel understood, listened to, and cared for, and learn to care about and empathize with others. Confronting the



patient's grandiose mode helps the lonely child mode to accept more realistic love without emphasizing the patient's need for validation. Helping the patient let go of maladaptive habits and avoidance behaviors of their disconnected self-soothing mode, which is replaced by real love, self-expression, and emotional experience (Young, Klosko & Weishaar, 2022: 534-535). The therapist primarily helps the patient to establish close relationships with themselves and other important people. They assist the patients in receiving and giving love and regaining trust by providing limited parenting (Ertürk & Kaynar, 2017).

As patients gradually satisfy the need for love within themselves, they no longer have to exhibit a diminishing or self-centered attitude towards others. Thus, both the grandiose and the disconnected self-soothing modes weaken and begin to disappear. Until this point, patients may not have known what real love is, so therapy can be the first step in establishing a relationship and they can realize if they have difficulty in building relationships. Narcissistic patients eventually behave in a grandiose manner towards their therapist, just as they do towards other people, and in such cases, it would be appropriate for the therapist to confront the patient empathetically. This can help the patients see their negative relationships with others, and the real transformation begins here (Young, Klosko & Weishaar, 2022: 566).

The therapist identified other existing complaints to prevent the patient from ending therapy after starting to establish a relationship in therapy. The therapist then connects with the patient's vulnerable child mode and attempts to show the patient that they care about this mode. The patient realizes that their need for love in the vulnerable child mode is being fulfilled. Therapists may demonstrate vulnerability to help the patient understand and empathize with it, emphasizing that it is of human quality. As therapy progresses, the patient may delve into the childhood origins of the vulnerable child mode, and at that point, the therapist can provide parenting to the vulnerable child mode and begin the process of improving the schema. Instead of coping modes, adaptive functions have been discovered, and their use has increased. Towards the end of therapy, the therapist teaches about schema modes and encourages discussion about them, and helps the patient generalize the changes they have made in therapy to their life outside of therapy.

### **Psychodynamic Psychotherapy**

According to Freud's personality theory, the basis is that "behaviors are influenced by unconscious processes, beliefs, behaviors, and passions that the individual is not aware of but still affect their behavior" (Hafizoğlu, 2019). Freud believed that personality develops in the first six years of life, and that any disorder is related to a problem experienced during this period.

The primary goal of psychoanalysis is to remove the amnesia cover that covers the first years of childhood and evokes conscious memory and demonstrations of childhood sexual life (Freud, 1933). Freud defined psychoanalysis as a method used to examine mental processes that cannot be examined in any other way, a technique used in the treatment of mental illnesses that originates from this research method, and knowledge accumulation consisting of psychological concepts obtained through this method will create a new scientific discipline



(Freud, 1933, cited in Sezeroğlu, 2020: 68). Jung, influenced by Freud's psychoanalysis, developed the psychodynamic approach to therapy, a theory that places less emphasis on sexuality. It basically consists of the same thought as psychoanalysis, but with less emphasis on sexuality.

### ***Narcissistic Personality Disorder in Psychodynamic Psychotherapy***

Psychoanalytic theorists have defined the concept of narcissism in different ways: From a psychodynamic perspective, the defense mechanisms of narcissistic individuals generally involve primitive defense mechanisms, such as splitting, denial, projective identification, omnipotence, and primitive idealization. According to Van der Wall, normal narcissism develops through normal object relationships, while pathological narcissism develops through pathological object relationships. Freud's first important work on narcissism is the article "On Narcissism: An Introduction." Freud believes that the basis of narcissism is related to sexuality and considers it as a libidinal investment that the individual makes in themselves, while Jung sees it as a situation related to time. According to Jung, a narcissistic person is someone who, due to not receiving the necessary care relationship in the early stages of life, tries to become self-sufficient and does not need anyone else. In the infants, an emotional bond with the caregiver could not be established as needed. The infant has invested in itself what it should have invested in the other, and has preferred to live in the inner world rather than in the outer world (Freud, 1914).

Kernberg, as a contemporary object relations theorist, describes narcissists as grandiose, excessively self-centered, and eager to obtain admiration and praise from others. They lack striking interest and empathy towards others. These individuals exhibit striking envy towards those who seem to have what they do not possess or appear to be satisfied with their lives. Narcissists lack emotional depth and cannot comprehend others' complex emotions. They also have difficulty differentiating their own emotions (Kernberg, 2016).

Kernberg considered antisocial personality disorder as a type of narcissistic personality disorder that arises from the insufficient internalization of moral values and leads to serious deviations in object relations (Çıkrıkçılı, 2018). According to Kernberg, narcissism is a defence mechanism that developed in response to early developmental obstacles. It places narcissism on a spectrum ranging from antisocial to malignant and narcissism as a severe form to a more mature form. Narcissistic individuals have a consistent way of working and can be socially successful, but their work and achievements serve for exhibitionism (Salman Akhtar & Thomson, 1982).

According to Kohut, narcissism is considered a healthy developmental phase, but pathological narcissism is seen as fixation during the normal developmental stage. People are born narcissists and gradually mature. Narcissistic development of the self emerges at two extremes: the "grandiose self" and the "idealized parental image" 'idealized parental image'. These develop in parallel, allowing for the formation of desires and ambitions at one point and goals and ideals at another in the self. If parents are unable to meet their child's needs during that stage and do not fulfill the functions of the self-object, disappointments occur in the child and developmental stagnation occurs as a result. If these disappointments occur in



the "idealized parental image," the person feels anxious when they perceive a threat but is not capable of soothing themselves because the parents who could have helped them through these early disappointments were unable to do so. On the other hand, if the mother does not mirror the child's developmentally appropriate grandiosity, disappointments occur in the "grandiose self". The child's narcissistic self does not change, and in later stages, the person evaluates themselves unrealistically while also experiencing feelings of inferiority, constantly oscillating between the two extremes. The fundamental characteristics of narcissistic personality are an exaggerated sense of self-worth and intense feelings of insecurity and inferiority underlying it (Burhanoğlu, 2017). While Kohut has a more positive and optimistic perspective on the concept of narcissism, Kernberg sees narcissism as a condition that continues into adulthood and needs to be studied intensively (Schmidt, 2019).

"One of the most common characteristics in the backgrounds of these individuals is the presence of cold parental figures with underlying, but intense, aggressive tendencies. Consistently, a parental figure (usually the mother) who is superficially well-organized and capable in the home, but who is somewhat emotionally distant, uninvolved, and taciturn with underlying aggressiveness, stands out." In such an environment, children develop severe oral frustration, resentment, and aggression, creating the necessary conditions for defense against excessive envy and hatred. In healthy individuals, the superego is integrated with ideal self-images and ideal object images; these ideal self-images, which are integrated with real self-images, create tension between the ego and the superego. However, in individuals with pathological narcissism, the pathological fusion between the ideal self, ideal object, and real self-images prevents the superego from integrating in this way, as idealizing processes prevent these idealized images from focusing on real parental demands and superego precursors identified as aggressive (Kernberg, 2016: 203-205).

Horney believes that narcissism is essentially an inflation of self-esteem, where the individual attributes greater value to their own abilities and qualities than is realistic. She argues that self-love and admiration are insufficient grounds for expecting others to feel the same way. Fenichel suggests that although narcissists may appear to be achieving success after success, they are not truly satisfied and try to fill a deeper void, which they only realize later. Reich develops the compensation theme, which many analysts believe underlies narcissism, and argues that the exhibitionistic urge harbors a contempt for those whose admiration is needed. Rosenfeld highlighted the tendency of narcissists to idealize their self-images and deny any deviation from perfection (Millon et al, 2019: 442). When the projective tests of individuals with narcissistic personality disorder are examined, depression and worthlessness often come to the forefront. When these results are evaluated, it is seen that unsuccessful identification has a negative effect on the individual who also experiences inadequacy in the superego structure due to object relationships during childhood. Individuals try to satisfy themselves internally but are unable to do so and feel a strong sense of worthlessness (Özen, 2020: 96).

### ***Kernberg and Kohut's Narcissist Comparison***



- 1- While Kernberg suggests that there is a period that can be overcome as one grows older, Kohut argues that developmental success leaves lifelong traces of its residues.
- 2- Kernberg proposed that the pathology of narcissistic personality disorder arises from a fixation in infantile narcissism and the combination of pathological self, ideal self, ideal object, and real self, whereas Kohut suggested that the pathology arises from a developmental arrest in early narcissism due to a failure to progress, leading to a persistent narcissistic self and an idealized parental image.
- 3- Kernberg argues that object relations involve devaluing-exploitative, idealizing, and feared-dangerous relationships, whereas Kohut proposes that they involve relationships of contempt and idealization.
- 4- While Kernberg emphasizes negative, destructive, controlling, and transformative potential in treatment, Kohut emphasizes positive transformative potential (Schmidt, 2019: 138).

### ***Treatment of Narcissistic Personality in Psychodynamic Psychotherapy***

Narcissistic personality disorder is a disorder in which it is very difficult to achieve change in treatment (Ronningstam & Weinberg, 2023). Narcissists' psychotherapy generally relies on Kohut's or Kernberg's therapy. Kernberg described an expressive psychotherapy in which confrontations are more commonly used. The main goal is to understand the origins of clients' conscious and unconscious anger. If there are any negative transferences towards the therapist, they are examined, and defense mechanisms such as splitting, reflection, and projective identification are addressed. The focus is on how inter-personal relationships experienced in childhood are re-enacted in the therapeutic relationship with the therapist. Understanding inter-personal connections leads to insights into problems in other relationships. On the other hand, Kohut argues that grandiose narcissism is a developmental obstacle that is related to insufficient or problematic communication during childhood. In this regard, an attempt has been made to revive early relationships in therapy. The therapist constantly shows empathy and understanding, and accordingly, provides mirroring, which reduces the client's need for a grandiose self (Millon et al, 2019: 475).

According to Kernberg, in individuals with narcissistic personality disorder, their ideal self, real self, and ideal objects pathologically merge, demonstrating that they have everything they want within themselves, without needing others (Yalçın, Ünal & Ülbe, 2017: 38). The therapist should be able to apologize if they make a mistake during therapy, but if they do so with shame, the narcissistic patient may think that feeling ashamed and making mistakes is bad and demeaning. Therefore, therapists should be able to demonstrate that apologizing is not something to be ashamed of. Narcissistic ruptures that may occur during therapy should be noted, as if they are not, the therapy can end suddenly.

### ***Masterson Approach***



Masterson developed the theory of abandonment depression. According to Masterson, an individual's psychological makeup consists of three basic elements: genetics, the environment, and fate. These three components interact with each other in an individual's psychological makeup and development of self, which can result in various personality disorders. Masterson classifies personality disorders according to developmental self or object relations. Narcissistic personality disorder is associated with grandiosity, preoccupation with fantasies, exhibitionism, weak responses to criticism, manipulative power, and exploitation.

There are three clusters of narcissistic personality disorder: exhibitionistic, closet, and devaluing. From a psychodynamic perspective, Masterson's approach to diagnosing personality disorders is based on the relationship between self-representation and object-representation. In narcissistic personality disorder, this self-representation and object representation may be intertwined, excluded from both representations, reflected in both representations, or acted upon (Özakkaş, 2016).

### *Narcissistic Personality Disorder According to the Masterson Approach*

Despite being a disorder that arises from a developmental halt in more primitive stages, narcissistic personality disorder is functionally more adaptive than borderline personality disorder. Masterson relies on Mahler's separation-individuation theory, and according to Mahler, narcissistic personality disorder is based on the practice stage. Some studies have shown that mothers of individuals with narcissistic personality disorder are emotionally cold and abusive toward their children. Narcissistic personality disorder consists of two main sections: libidinal and aggressive. According to Masterson, the Libidinal section is a defensive fused unit that is charged with libidinal energy. The second section was charged with aggression. The feelings in the libidinal section were unique, special, appreciated, perfect, and flawless. In the Aggression section, there are feelings of depression, anger, fear and panic, emptiness and nothingness, guilt and shame, and passivity were assessed. The fundamental defense mechanisms of Narcissistic Personality Disorder include primitive splitting, avoidance, denial, projective identification, projection, and introjection (Katz, 2016).

- **The Exhibitionist Narcissist:**

A narcissistic individual who has made a libidinal investment in themselves is characterized by a grandiose and reality-denying structure. They generally seek to be the center of attention and admiration in areas such as money, beauty, power, and desirability. The patient expects the therapist to reflect on these areas back to them and assumes that this is being done when the therapist remains silent. The reasons for coming to therapy are generally the loss of a person, abandonment, career change, aging, or illness, which often involves a loss of narcissistic supplies. These often reveal the voids in their relationships. An individual's condescending style suddenly falls, depression increases, and feelings of emptiness and anxiety are observed. A person is unfamiliar with these emotions and does not know how to cope with them because they have not experienced them before (Katz, 2016). This phenomenon can also be referred to as grandiose narcissism.





- **Closet Narcissist:**

If libidinal investment is made in an object, the individual feels completely owned by it under the object's protection and lives in its happiness. They idealize the object and illuminate themselves in the light of this idealization. This creates a spontaneous sense of self: however, the self is grandiose, special, and contains unique feelings. They often criticize and attack themselves. They want to be "perfect in every way," but they cannot be perfect. These individuals are more delicate and find it difficult to keep moving because they gain a sense of self by focusing on something other than themselves. Consequently, they feel inferior, which can lead to depression (Katz, 2016). A person hides their narcissistic personality.

- **Devaluer Narcissist:**

A narcissist who cannot use idealization excessively and is not grandiose. Individuals spend most of their time in an aggressive mode, and when attacked, they become angry and externalize this anger by attacking others. They have little or no self-activation and often struggle with impulse control, feeling the need to isolate and protect themselves (Katz, 2016).

### ***Narcissistic Personality Disorder Treatment in the Masterson Approach***

According to Masterson, confrontation is not very frequent in the treatment of narcissistic personality disorder, and it is more appropriate to work with the mirroring technique for interpreting narcissistic vulnerability. Owing to the patient's impaired reality evaluation abilities and a defense mechanism that is highly prone to denial, it is best to first mirror the emotions that arise from the injury and then interpret the narcissistic injury for the treatment to progress correctly. However, if we confront these individuals directly and show their defenses, they may quit treatment. There are three parts to mirroring narcissistic vulnerability: pain, self, and defense. Importantly, the therapist should observe the patient when interpreting the mirroring of narcissistic vulnerability (Katz, 2016).

## **CONCLUSION and RECOMMENDATIONS**

Narcissistic Personality Disorder often displays similar behaviors within the framework of psychotherapeutic approaches. Being admired and receiving attention are fundamental reasons for their existence. From a psychodynamic perspective, they require grandiose feelings to prevent inferiority complexes, and a therapy that involves more confrontation should be applied. In the Masterson approach, which is a psychodynamic theory, Masterson classifies narcissists into three types: Exhibitionist, Closet, and Devaluer. Unlike dynamic therapy, Masterson argues that a treatment approach focuses less on confrontation and more on mirroring and interpreting narcissistic vulnerability for these clients. In Cognitive Behavioral Therapy, the goal is to reduce behaviors with a more specific language than narcissists want and expect, with empathy. This directs people towards more realistic goals and thoughts. Providing psychoeducation for communication and social adaptation will be beneficial for the person, and schema therapy aims to stand beside the active modes that the patient uses and gradually reduce the person's need for that mode. For example, if an



individual was not listened to during childhood, they will be listened to in their current life to reduce their need for the child mode. In conclusion, every therapy approach can use various methods for a disorder and the effectiveness of each has been proven individually. The important thing is to determine what the patient really needs and which method will provide a faster and more positive response. According to the literature review conducted, there are few studies on narcissistic personality disorder that each approach has investigated individually, and there are not enough articles within the framework of psychotherapy approaches. Conducting further research on narcissistic personality disorder would make a significant contribution to the literature on this topic.

## REFERENCES

*American Psikiyatri Birliđi. Ruhsal Bozuklukların Tanısal ve Sayımsal Elkitabı, Beşinci Baskı (DSM-5). (2014). Tanı Ölçütleri Başvuru elkitabı (çeviri ed. E Körođlu) Ankara: Hekimler Yayın Birliđi.*

Burhanođlu, S. (2017). *Narsisizm Gelişim Kuramları*. Dr. Sabri Burhanođlu: <https://www.sabriburhanoglu.com/narsisizm-gelisim-kuramlari> adresinden alındı.

Caligor, E., Levy, K. N. & Yeomans, F. E. (2015). Narcissistic personality disorder: diagnostic and clinical challenges. *American Journal of Psychiatry*, 172(5), 415-422.

Çıkrıkçılı, U. (2018). *Antisosyal kişilik bozukluđu tanısı almış cinayet hükümlülerinde karar verme, duygu tanıma davranışlarının psikopati açısından incelenmesi ve sağlıklı kontroller ile karşılaştırılması*. (Tıpta uzmanlık tezi, İstanbul Üniversitesi, İstanbul tıp fakültesi, Ruh Sağlığı ve Hastalıkları Anabilim Dalı) Ulusal Tez Merkezi.

Dieckmann, E. & Behary, W. (2015). Schema therapy: an approach for treating narcissistic personality disorder. *Fortschritte der Neurologie-psychiatrie*, 83(8), 463-77.

Ertürk İ. Ş. & Kaynar, G. (2017). Kişilik bozukluklarında şema terapi yaklaşımı. *Ufuk Üniversitesi Sosyal Bilimler Enstitüsü Dergisi*, 6(12),98-110.

Freud, S. (1914). *Narsisizm Üzerine ve Scherber Vakası*, (Çeviri: Mustafa Atakay), Metis Yayınları.

Güler, K. (2020). *Şema Terapi*, Fatih Bal (editör). "Klinik Psikolojide Kullanılan Psikoterapi Yöntemleri", (p. 398) Nobel Yayınları.



Güzel., H. Ş. (2022). “*Kişilik bozuklukları*”, “*Dsm-5’e göre Anormal Psikoloji*”, (Editörler: Ezgi Tuna ve Öznur Öncül Demir), Nobel Yayınları.

Hacak. E. (2023). *Narsistik Kişiliğe Psikanalitik Bakış*. Ethos Psikoloji: <https://ethospsikoloji.com/narsistik-kisilige-psikanalitik-bakis/> adresinden alındı.

Hafızoğlu, A. D. (2019). *Üniversite Öğrencilerinin Savunma Mekanizmaları ile Duygusal Şemaları Arasındaki İlişkinin Değerlendirilmesi* (Yüksek Lisans Tezi, İstanbul Sabahattin Zaim Üniversitesi Sosyal Bilimler Enstitüsü) Ulusal Tez Merkezi.

Karaaziz, M. & Erdem Atak, İ. (2013). Narsisizm ve narsisizmle ilgili araştırmalar üzerine bir gözden geçirme. *Nesne*, 1 (2), s.44-59.

Katz, J. S. (2016). *Narsisistik Bozukluğun Ayırıcı Tanısı*. Psikoterapi Enstitüsü: <https://www.psikoterapi.com/narsisistik-bozuklugun-ayirici-tanisi/> adresinden alındı.

Kaya, C. (2022). *Şema Terapi*. Cemkaya: <https://cemkaya.net/terapi-tekniklerim/sema-terapi-150> adresinden alındı.

Kernberg, O. (1975). *Sınır Durumlar ve Patolojik Narsisizm*. (Çeviren. M Atakay), 2016, Metis Yayınları.

Köroğlu, E. & Bayraktar, S. (2010). *Kişilik Bozuklukları*, Ankara: HYB Basım Yayın.

Masterson, J. F. (2014). *Narsisistik ve Borderline Kişilik Bozuklukları Bir Bütüncül Gelişimsel Yaklaşım*. İstanbul: Psikoterapi Enstitüsü.

Millon, T., Grossman, S., Millon, C., Meagher, S. & Ramnath, R. (1996). *Modern Yaşamda Kişilik Bozuklukları*, Türkiye İş Bankası Kültür Yayınları.

Özakkaş, T. (2016). *Masterson Yaklaşımına Genel Bakış*. Psikoterapi Enstitüsü: <https://www.psikoterapi.com/masterson-yaklasimina-genel-bakis/> adresinden alındı.

Özen, S. (2020). *Kişilik Bozuklukları*. İstanbul: Siyah Beyaz.

Öztürk, Ö. (2016). *Dünya Mitolojisi*. Nika Yayınları.

Roediger, E. (2015). *Şema Terapi Nedir? Şema Terapinin Temellerine, Modellerine ve Uygulanmasına Giriş*, (Çev. S. Ataman). Nobel Yayınları.



Ronningstam, E. & Weinberg, I. (2023). Narcissistic personality disorder: patterns, processes, and indicators of change in long-term psychotherapy. *Journal of Personality Disorders*, 37(3), 337-357.

Salman Akhtar, M. D., & Thomson Jr, J. A. (1982). Overview: Narcissistic personality disorder. *Am J Psychiatry*, 139(1), 12-20.

Sezeroğlu, H. (2020). “Dinamik Terapi,” *Klinik Psikolojide Kullanılan Psikoterapi Yöntemleri*, (Editör: Fatih Bal). Nobel Yayınları.

Schmidt, A. (2019). Comparison of kernberg's and kohut's theory of narcissistic personality disorder. *Türk Psikiyatri Dergisi*, 30(2).

Şenkal, İ. E. & Kaynar, G. (2017). Kişilik bozukluklarında şema terapi yaklaşımı. *Ufuk Üniversitesi Sosyal Bilimler Enstitüsü Dergisi*, 98-114.

Taymur, İ., & Türkçapar, M. H. (2012). Kişilik: tanımı, sınıflaması ve değerlendirmesi. *Psikiyatride Güncel Yaklaşımlar*, 4(2), 154-177.

Timuroğlu, K. & İşcan, Ö. F. (2010). İşyerinde narsisizm ve iş tatmini ilişkisi. *Atatürk Üniversitesi İktisadi ve İdari Bilimler Dergisi*, 22 (2), 239-264, Retrieved from <https://dergipark.org.tr/tr/pub/atauniiibd/issue/2694/35471>.

Türkçapar, M. H. (2020). *Bilişsel Davranışçı Terapi Temel İlkeler ve Uygulama*. İstanbul: Epsilon Yayınevi.

Yalçın, Ç., Ünal, B. & Ülbe, S. (2017). Narsisistik kişilik örgütlenmesi ve narsisistik savunmaların nesne ilişkileri kuramı çerçevesinde incelenmesi: vaka ve süpervizyon çalışması. *Ayna Klinik Psikoloji Dergisi*, 37-47.

Yıldırım, D. D. (2020). “Bilişsel Davranışçı Terapi,” *Klinik Psikolojide Kullanılan Psikoterapi Yöntemleri*, (Editör: Fatih Bal), Nobel Yayınları.

Young, J. E., Klosko, J. S. & Weishaar, E. M. (2022). *Şema Terapi*. Litera Yayıncılık.



## NARCISSISTIC PERSONALITY DISORDER AND ITS TREATMENTS WITHIN THE FRAMEWORK OF PSYCHOTHERAPY APPROACHS

### GENİŞLETİLMİŞ ÖZET

Narsisizm ismini Yunan mitolojisindeki Narkissos Efsanesinden almaktadır. Narkissos sudaki yansımasında kendisini görmüş ve âşık olmuştur, bu aşk sonucunda da ölmüştür. Narkissos efsanesinden de anlaşılacağı üzere Narsisizm, kişinin kendisine duyduğu yoğun sevgiyi ifade etmektedir.

Narsisistik kişilik bozukluğu yaşayan bir birey genel anlamda her şeyde en iyisini arar, güç, güzellik ve zenginlik elde etmeye çalışır. Kendisine hayran olacak kişiler ararlar ve bulmak için yoğun bir çaba sarf ederler. Narsisist bireyler içlerindeki haset duygusuyla karşısındaki insanlara zarar verirler. Öz saygılarını diğer insanlardan onay alarak sürdürürler. Narsisistik bireyler gördüklerinin aksine başkalarına derin bir ihtiyaç duyarlar fakat sevgileri sığdır. Narsisistik kişilik bozukluğu olan bireyler kendilerini her şeye lâyık gördükleri için empatiden yoksundurlar, bu sebeple yakın ilişkilerde bulunmamaktadırlar. Kendilerinden bahsetmekten oldukça hoşlanırlar ve genelde kendi düşünceleri yoktur, büyük adamların ve liderlerin düşüncelerini benimsemiştirler. Narsisist bireylerin çoğunlukla ebeveynleri de narsisisttirler.

“Psikoterapi Ekolleri Çerçevesinde Narsisistik Kişilik Bozukluğu ve Tedavileri” isimli bu çalışmada literatür taraması yapılmıştır. Narsisizm kelimesinin kullanıldığı ilk günden bu güne dek narsisizmin tanımlanma şekli ve kullanılan etkili tedavi yöntemleri bir bütün halinde sunulmaya çalışılmıştır. Daha önce yapılmış araştırmalarda belirli ekoller çerçevesinde narsisizm incelenmiş fakat birkaç ekolün bir arada sunulduğu bir çalışmaya rastlanılmamıştır. Narsisizmin tanımlanması ve tedavisi oldukça tartışmalı bir konudur bu sebeple kullanılan yöntemler bir bütün halinde sunulması katkı yapılması amaçlanmıştır.

Narsisistik kişiliğin 4 çeşidi vardır. Bunlar: İlkesiz Narsisist (antisosyal özellik gösterenler), Elitist Narsisist (her şeyi kendine hak görenler), Şehvetli Narsisist (histrionik özellik gösterenler) ve Telafici Narsisist (kaçıngan özellik gösterenler) şeklindedir.

Bilişsel Davranışçı Terapi, Narsisistik kişilik bozukluğunu değişken ve kırılabilir benlik saygısı, ilgi çekme ve onaylanma arayışıyla bunları düzenleme girişimleri ve açık ya da örtük büyülenme kişilik olarak tanımlar. Bilişsel davranışçı terapiye göre Narsisistik kişilik bozukluğunun şu şekilde yerleşik düşünceleri vardır: “Ben çok özel biriyim”, “Ayrıcalık hak ediyorum”, “Hayran olunmam gerek”, vs.

Bilişsel davranışçı terapinin, Narsisistik kişilik bozukluğu tedavisinde hedefleri genel olarak; karşılaştırmacı ya da yüceltici dil, özel davranılma ya da ayrıcalıklar beklentisi, kuralları görmezden gelme, kuralların başkaları için olduğunu düşünme, arkadaşlıklarda aşırı seçicilik gibi davranışların azaltılması; empati ve perspektif alma, eleştiriye açık olma davranışları ise artırılması gereken davranışlar şeklindedir.

Tedavi de aynalamak oldukça önemli bir unsurdur. Narsistlerin biricik olma istekleri çok fazla bilişsel çarpıtmaya sebep olmaktadır. Bunun önüne geçmek için ise daha gerçekçi düşünce kalıpları bulmak gerekir. Bu kişiler kendilerini üstün görmek yerine kişisel benzerlikler ararlarsa bu daha empatik bir yaklaşım olacaktır. Empati geliştirmek için de rol yapma



teknikleri kullanılabilir. Diğer yandan eğer terapist danışanı çok fazla desteklerse birey fazla şişip değişmeye ihtiyaç duymadığını düşünebilir.

Şema terapide Narsisistik kişilik bozukluğu için üç temel mod vardır: Yalnız Çocuk Modu, Büyüklenme Mod ve Kopuk Kendini Uyuşturucu Mod. Kişi bunlardan hepsine veya bazalarına sahip olabilir. Narsisistik kişilik bozukluğu olan çoğu hasta gerçek sevgiyi deneyimleyemedikleri için hayat boyu duygusal yoksunluk ve kusurluluk şemalarını sürdürebilirler. Duygusal yoksunluk şemasına sahip olmalarının temel sebebi kendilerine yakın olan kişilerden çok fazla şey talep etmeleri ve çok az şey vermeleridir. İhmal edilmiş ve yanlış anlaşılmış olmalarının temel sebebi de duygusal yoksunluk şemasından kaynaklanmaktadır. Kusurluluk şemasına sahip olma sebepleri ise narsistler çoğunlukla kendilerini kusurlu hissederler bu yüzden de yakın ilişkilerden kaçınırlar. Herhangi bir kusurunun ortaya çıkmasının küçük düşürücü olacağına ve sonucunda reddedileceğine inanırlar.

Şema terapinin tedavisinin ana hedefi ise otomatik davranışın yerine kontrollü davranışın almasıdır. Terapist temel olarak hastanın sağlıklı yetişkin modu oluşturmasına yardımcı olmaktadır. hastanın ilgilenilmiş ve dinlenmiş, anlaşılmış hissetmesi, başkalarıyla ilgilenmesi ve empati kurması için yalnız çocuk moduna yardımcı olur.

Terapist önce hastanın kendisiyle ve diğer önem verdiği kişilerle yakın ilişkiler kurmasına yardım eder. Hastaya sınırlı ebeveynlik yaparak sevgi alabilmesi, verebilmesi ve yeniden güven duymasına yardımcı olur. Hasta giderek sevgiyi benliğinde doyurdukça artık başkalarını küçültücü veya benmerkezci bir tavır sergilemek zorunda kalmaz. Bu şekilde hem büyülenme modu hem kopuk kendine uyuşturucu modu zayıflamaya ve yok olmaya başlar. Narsisistik hastalar eninde sonunda terapist de diğer insanları davrandıkları şekilde büyülenme bir şekilde davranırlar bu ve bu gibi durumlarda terapistin hastayla empatik bir şekilde yüzleşmesi sağlıklı olacaktır. Terapist bir süre sonra danışanın yalnız çocuk moduyla bağlantı kurar ve onunla ilgilenildiğini gösterir. Hasta bu noktada yalnız çocuk modunun sevgi ihtiyacının karşılandığını görür. Daha sonralarda hasta yalnız çocuk modunun çocukluk kökenle iner o noktada ise terapist yalnız çocuk moduna ebeveynlik yapıp şemayı iyileştirme sürecine başlayabilir. Baş etme modları yerine uyum sağlayıcı işlevler keşfedilir ve bunların kullanımını arttırılmaya çalışılır.

Psikanalitik kuramcılar narsisizmi bir çok farklı şekillerde tanımlamışlardır Psikodinamik ekole göre narsisist bireylerin altta yatan derin bir aşağılık duyguları vardır ve bunu önlemek amacıyla büyüklük duygularına ihtiyaç duyarlar. Freud'a göre narsisizmin temeli cinselliktir ve kişinin kendisine yaptığı bir libidinal yatırımdır. Jung'a göre ise narsisistik birey, yaşamının ilk döneminde alması gereken bakımı alamamış ve kendine yetmeye çalışan bir bireydir. Kişi ötekine yapması gereken yatırımı kendisine yapmıştır ve iç dünyada yaşamayı tercih etmiştir. Kernberg ise narsisizmi patolojik bir gelişim olarak tanımlamıştır. Narsisizmi erken gelişim dönemlerinde yaşanan engellemelere karşı geliştirilen bir savunma türü olarak görmüştür. Kernberg narsisizmi ağır bir tabloda daha olgun bir tabloya doğru giden bir spektruma yerleştirmiştir Kohut ise patolojik narsisizmi normal gelişim döneminde yaşanan bir fiksasyon olarak ele almıştır. İnsanlar doğuştan narsisistlerdir ve gittikçe olgunlaşırlar.



Bireyin çocukluk döneminde yaşadığı sorunlar sebebiyle yüzeyde abartı bir kendilik değeri oluşur fakat altta yatan yoğun bir güvensizlik ve aşağılık duyguları vardır.

Narsisistik kişilik bozukluğunun tedavisinde genellikle Kohut'un veya Kernberg'in terapileri temel alınır. Kernberg genelde yüzleştirmelerin sık yapıldığı bir terapiden bahseder. Burada danışanın öfkelerini anlamak ve savunma mekanizmalarını nasıl kullandığına bakmak gerekir. Kohut ise erken dönem ilişkilerini tekrar canlandırmaya çalışır. Terapist sık olarak empati ve anlayış göstererek aynalama yapar, böylece danışan büyüklenmeci benliğe daha az ihtiyaç duyar.

Masterson'a göre narsisizm üç kümeden oluşur ve bunlar; Teşhirci Narsisist, Gizli Narsisist ve Değersizleştirici Narsisist şeklindedir. Masterson tedavide yüzleştirmenin sık olmadığı, daha çok narsisistik zedelenmenin yorumlanması için aynalayarak yorumlama tekniğini kullanmayı önerir. Hastanın gerçeği değerlendirmesindeki bozukluklar ve inkarı sık kullanan bir savunmada olması sebebiyle önce zedelenmenin ortaya çıkardığı duyguları aynalayarak ardından da bu zedelenmeyi yorumlayarak terapide ilerlemeyi savunur.



## THE INFLUENCE OF FRENCH LITERATURE ON THE OTTOMAN LITERATURE

**Dr. Ulker SAMADOVA**

Azerbaijan National Academy of Science, Institute of Oriental Studies,

Orcid. 0009-0004-3967-5117

### ABSTRACT

French influence began to attack Ottoman literature with all its might in the first half of the 19th century. The fact that the Ottoman Empire was lagging behind Europe in everything - be it literature, civilization, or war were an indication of the inevitability of renewal and even Europeanization. In the field of literature, at the request and request of the population, who were tired of the old divan literature and needed to simplify the language, writers began to Europeanize after Frenchization.

First of all, intellectuals went to France to study and learn the French language, and then the translations of French literature and the interest of French newspapers in the Ottoman Empire led to great developments in the country's westernization. From French literature, Fenelon, Victor Hugo, Voltaire, Alexandre Dumas, Chateaubriand, Longus, Daniel Defoe, Lassage, Bernardin de Saint-Pierre, Paul de Kock, Xavier de Montepin, Edmond Tarbe, Ponson de Terrail, Eugen Sue, Frederic Soulie, Pierre Zaccone, Emile Richebourg, Lapointe, Emile Gaboriau, Fortune du Boisgobey, Jules Verne, Alphonse de Lamartine, etc. His works were translated into Turkish and the readership got to know the novel in this way. Later, in Ottoman literature, 'Taashshuki Talat ve Fitnat', 'Felatun beyle Rakım Efendi', 'Araba Sevdası', 'Intibah', 'Cezmi', etc., were novels written under the influence of the above-mentioned French authors.

The second issue was newspapers. The fact that newspapers were read and received great attention in France led to the publication of newspapers and magazines in the Ottoman Empire after 1860. It resulted in the publication of many newspapers such as "Tasvir-i Efkar", "Takvim-i Vekayi", "Ceride-i Havadis".

The third issue a special Ottoman audience was introduced to the theater. After receiving the approval of Sultan Selim of that time, the Guistiniani theater was started to be established in Istanbul after the intellectual class, who had studied in France and lived there for a while, had a meeting of ideas about this issue in the palace. In the first years, works in Armenian and Turkish were presented, and after a few years, Turkish writers' own works were presented.

The fourth issue is the influence of French on Turkish in literature in the field of poems. The translation of French works into Turkish became even more important. The intensity of translation that began in the Tanzimat literature continued in the literature of Servetus-





i Fünun. Many writers of this movement were influenced by French and continued to write their works under this influence. Ahmet Mithat Efendi and Rezaizade Mahmut Ekrem, one of the authors of Tanzimat Literature, are among our authors who use French words the most in their works. Rezaizade Mahmut Ekrem's novel *Araba Sevdası* has so many French words that a French-Turkish dictionary was created behind the novel. Ahmet Mithat Efendi de Felatun Bey and Rakım Eendi wrote a lot of French words in his novel.

**Key words.** Frech influence, theatre, magazines, novels, translation issues.

## INTRODUCTION

After signing of the Treaty of Paris (1856), Westernization and other reforms were adopted by the Ottoman government as a strategy to protect the state in existence. The Christian Question in the Empire as well as the pressures of the Great Powers emerged to become the most important reasons to impel the Ottoman Government to carry out reforms. The Ottoman Empire and the Habsburg Empire were the countries that attempted to find a way out of the political difficulties and challenges arising from the legacy of an ancient regime, emerging nationalist movements and imperialist aspirations of Western powers and Russia.

After the declaration of the Islahat Fermanı and the signing of the Treaty of Paris in 1856, the West's expectations from the Ottoman State and the amount of the pressure they put on it for reforms increased. However, as we shall see in this chapter, the Empire was entangled in a web of problems. All the problems about the administration of the country had to be reconsidered; disintegration of the Empire was inevitable as long as the existing structure remained in place. This was clearly visible in the light of the general situation of the country.

### Appearing of novel genre

The Turkish society, which turned its face to the West with the Tanzimat movement, was influenced by the West in terms of political, social and literary fields. It is known that each literary period feeds on the social events of its own time. In the new period that emerged with the Tanzimat, the changes in the structure of the state and society also affected the literature. Tanzimat has an important place in Turkish life because of the changes and developments which occurred in politics, society and literature. Tanzimat Literature exists by taking Occidental Literature as its model. The Literal changes are aimed at the Occident, especially French Literature. The authors, stuck between the Orient and the Occident, reflect their dilemma to their works, too. Therefore, our literature is between Oriental and Occidental cultures. The artist who think the same as Western people but live like Eastern people grow distant from the old literature in the



course of time. The main theme of Tanzimat novels is Occidentalization. The changes in Ottoman social structure in XIX. Century affect Turkish people on a large scale. The function which novel undertakes in this period should be taken into consideration. The novel taken from the Occident begins to be used as a means of modernization. Tanzimat novelists, who regard novel as a means of education and occidentalization, not only want to become Occident while being devoted to Oriental values but also accept occidentalization as inclining towards Oriental values at the same time. Therefore, authors have a cultural dilemma. In this process, changes occur in both state structure and society's cultural values. Dilemmas occur especially in morals, sorts of individuals, education system, traditions, enjoyment and social life

### **Changes in newspaper field.**

The press has an incontrovertible significance in the life of both states and societies. This significance stems from the molder and router characteristics of the press on states and societies are their independence. The first samples of the press in the Ottoman Empire were generated with the activities triggered the making of the original Ottoman Press. In addition to this impact, it is an incontrovertible fact that the idea of following or catching the changing and diversifying world order affected the creation of original press. Mahmut the second and the state officials played an important role in preparing the state to the Tanzimat (And, 1972). In additions to reforms on state and society, the idea and realization of a Turkish newspaper is introduced for the first time in the Tanzimat period. This period with a newspaper, started with Takvim-i Vekayi in 1831, can be identified as the genesis and developing **period of the media in Turkish history**. There is a strong bond between literature and newspapers in Turkish journalism that began to develop during the second half of the nineteenth century under the influence of France. Newspapers have positively influenced literature and directly influenced the development of new literature. When the people from Ottoman went to France in order to learn the language they came across with newspaper and read news from it every day. After returning to their country opened here the publishing houses and tried to publish different newspapers for entertaining and to educating the people.

### **The establishment theatre**

The Tanzimat (reorganization) man saw the greatest distinction between Western theater and Ottoman theater as in framed theater and written text. At the beginning, we come across a number of early experiments to complete this dilemma. We encounter four theater buildings in Istanbul in 1839, when Gülhane-i Hatt-i Humayun (the imperial edict of Gülhane) was declared, Two of them were representatives of foreign circus communities. As a matter of fact, the Gedikpaşa Theater, which we would come across in the future, was a cambazhane (illusionist theatre) built for the representation of the circus.

The development of written dramatic text was later. Nevertheless, it can be said that there were earlier trials. We come across a number of Turkish plays written among the studies



of the Eastern Language School, which was opened to educate young people who knew the languages of these countries to be employed in the embassies of the Eastern countries of the European states. In addition, there was a play translation of the St.Lazar monastery in Venice published in Turkish with Armenian letters. Moreover, a feature of this second essay was that it was written in Turkish, in pure Turkish. In the real sense, the first Turkish theater play was the “Poet Marriage” written by Ibrahim Sinasi Efendi for Dolmabahçe Saray Theater in 1859 (Dino, 2008)

Another factor contributing to the development of the Western theater in the Ottoman lands was the interest of Turkish statesmen and intellectuals towards the theater. The Turkish ambassadors in foreign countries have contributed to the Ottoman adaptation of their theatrical works, which they saw when they returned to the Western theater as they enlightened the Ottomans on their chiefs and reports. Arifi Pasha, who had been the ambassador of Vienna, prudence and grand vizier, was initially charged with the strict supervision of the theaters. As a matter of fact, in the future it was quite a vision for the age to turn the German classics into Turkish and to act them. In the palace, Safvet Bey made a turn from Moliere in 1847 and organized performances at Müzik-i Humayun (the imperial band/orchestra (of the Ottoman Empire)). These include the positive influence of the theatrical development of Bursa Governor Ahmet Vefik Pasha, Adana Governor Ziya Pasha, Trabzon Governor Ahmet Bey (Aktel, 1998).

In addition to the state officials who we mentioned above, another factor contributing to the development of Western theater was foreign embassies. Some foreign ambassadors had made theater halls in the embassies and gave presentations there. Not only embassy officials, but also by the public were invited for these demonstrations. Those who wrote and acted were among the embassy staff.

It is also important not to forget the foreign communities that have come to the country to made demonstrations in the development of the Western theater. These have played a major role not only in the growth of the audience and the formation of theater culture but also in the development of local theater actors. They served as a kind of teaching tasks for local theater actors.

### **Translations**

With the Westernization movement, Turkish society has experienced important changes in social, cultural and literary life as in many areas. In this process gaining acceleration through Tanzimat, Turkish literature entered into a renewal process and the translations made from the West has played an important role in shaping this new literature. In Tanzimat Period mostly novels were translated and a large part of these translations were performed from the popular novelists. In this period, the popular novel translations which attracted great acclaim by the masses became an important tool in recognition of Western culture and civilization. The officials of those times were trying to encourage everyone to learn a foreign language keeping in mind the proverb “A man who speaks a language is a



man, a man who speaks two languages is worth two men, a man who speaks three is worth all mankind.” For example, the newspaper Mecmua-i Lisan (1898-1900) taught its readers French through translation. During the Tanzimat Period of the Ottoman Empire, when “western literature” was mentioned, French literature was the most acknowledged among all. Almost all of our writers were influenced by French writers when writing their first books. For this reason, most of our writers knew French. For example, Şinasi learned French while working as a secretary at Reşat Bey’s office. Later on, when he went to France, he started to be well known in literature by translating Lamartine’s books. Another example is Ziya Paşa, who knew French and Arabic. He learned French while working at the Palace as a secretary; Ethem Pacha helped him to learn it. When he was in Switzerland, he translated J.J. Rousseau’s “Emile” and “les Confessions”. Namık Kemal learned French with some encouragement from Şinasi, and worked in the “translation office” as a translator. Later on, when he was abroad, he received his education on Law and Sociology. Recaizade Mahmut Ekrem knew Arabic, Persian and French; he became a teacher at the Galatasaray High School from 1880 to 1888. He was influenced by Hugo and Lamartine. According to Ahmet Mithat Efendi’s son Kamil, his father learned French in 17 months and soon after that he learned Arabic, Persian, English, Italian, Latin and Greek in succession. Other writers of the Tanzimat Period who knew French very well were Sami Pacha Sezai, Abdülhak Hamit Tarhan, Münif Paşa and Şemseddin Sami Bey. The writers of Servet-i Fünun also knew French as the writers of the Tanzimat Period did. For example the founder of modern poetry Tevfik Fikret graduated from the Galatasaray High School (in 1867-1915). Cenap Şahabettin was sent to France to complete his education in medicine. Halit Ziya Uşaklıgil finished the French Catholic High School and later went to France (Okay, 2012). Mehmet Rauf, Hüseyin Cahid Yalçın, Süleyman Nazif, Ahmet Hikmet Müftüoğlu also knew French very well. Besides national literature, in novels and stories, it is possible to see a tendency from personal life to social life. Turkish literature in the period of innovation developed under the influence of European literatures, especially French literature. During this process, translation activity has also been extremely effective in the search for literary genre and content in Turkish literature (Kara, 2010)

. The first translated works were published in newspapers and magazines and then published as a book. Within the scope of the thesis, first of all, the stories translated from French in the literary magazines published between 1860-1891 were determined. Then, the translated books, treatises and anthologies published in the relevant time period were scanned and the translated stories in them were determined.

## Conclusion

XIX. Century is a changing century for the Ottoman Empire. Subject of mythesis is the examination of French effects during this changing period. Especially, the period beginning at 1856 whit Hatt-ı Humayun is characterized as French century of the Empire. British and French ambassadors participated in the meeting held for the purpose of issuing



Hatt-I Humayun. Edouard Thouvenel participated on the meeting for issuing Hatt-ı Humayun, on behalf of France and undertaking French embassy duty until 1855 was the diplomat starting the French century. General evaluation of France about Ottoman reforms were summarized in French reform program written in 1867. It is possible to get results about general approach of France about Ottoman reforms by means of this evaluation. The proposals of France about reforms were recognized generally by the Tanzimat bureaucracy. The reason for this recognition is the consistency of French thesis with targets of Tanzimat. The proposals of France to lead egalitarian and secularization were in parallel with Ottomanism being the official view of Tanzimat. France became a model country for reformist bureaucracy of Bab-ı Ali.

### REFERANCE

Aktel, M.(1998), *Tanzimat fermanının toplumsal yansıması*. İstanbul; İktisadi ve idari bilimler fakültesi dergisi, 1998, p.177-184.

And, M.(1972), *Tanzimat ve istibdad döneminde türk tiyatrosu 1839-1908*, Ankara; Türkiye iş bankası kültür yayınları, 487 p.

Dino, G. ( 2008), *Türk romanının doğuşu*. İstanbul; agora kitablığı, 224 p.

Kara, S.V. (2010), *Tarihsel değerlendirmeler ışığında Türkiyede çeviri etkinliği*, Mersin; Mersin Üniversitesi eğitim fakültesi dergisi, N1, p. 94-101.

Koç, O. (2012), *Tanzimat dönemi edebi nesrinde üslup değişimleri*, Sakarya, 354 p.

Okay, O. (2013), *Batılılaşma devri türk edebiyatı*, İstanbul; Dergah yayınları, 278 p.

[http://www.dilededebiyat.org/Dersnotlari/tanzimat\\_edebiyati.html](http://www.dilededebiyat.org/Dersnotlari/tanzimat_edebiyati.html)

[https://tr.wikipedia.org/wiki/Hatt-ı\\_hümâyun](https://tr.wikipedia.org/wiki/Hatt-ı_hümâyun)

<https://tr.wikipedia.org/wiki/Tanzimat>

<http://www.turkedebiyati.org/tanzimat-edebiyatinin-olusumu.html>

<http://www.edebiyatfatihi.net/2014/09/tanzimat-edebiyatolusumu1donem2donem.html>



## PACKAGING COLLABORATIONS WITH ARTIFICIAL INTELLIGENCE

**Beyza DURUCU**

Packaging R&D Executive, Dimes Food Ind. and Inc.

ORCID NO: 0009-0007-5401-3965

### ABSTRACT

Artificial Intelligence (AI) is a machine's ability to perform the cognitive functions we associate with human minds, such as perceiving, reasoning, learning, interacting with an environment, problem solving, and even exercising creativity. AI technology continues to propel the food industry at a rapid pace. We've seen many innovations related to the service, production, packaging and distribution of food over the years. These changes all aim to protect public health and create a more efficient and sustainable food industry. In this study, the topics of packaging design, food safety and sustainability in the food industry with artificial intelligence were examined. Firstly, with artificial intelligence, consumers' habits are analyzed in detail and play a guiding role in packaging design. On the other hand, it provides important data in the food industry by providing controls on food safety and quality with artificial intelligence systems and supporting it with sensory analyses. Finally; AI aims to provide the most appropriate sustainable packaging selection by analyzing the component of the product. In this study, details of packaging collaborations with artificial intelligence have been compiled. I wish to acknowledge to Dimes Food Ind. and Inc. for their valuable supports to the study.

**Key Words:** artificial intelligence, food industry, packaging



## ALTERNATIVE METHODS AND TECHNOLOGIES TO THE USE OF SO<sub>2</sub> IN WINE PRODUCTION

**Pelin YAZICI KARAYAĞIZ**

R&D Engineer, Dimes Food Ind. and Inc.

ORCID: 0009-0005-7027-8723

### ABSTRACT

SO<sub>2</sub> plays an key role in the production, maturation and/or bottle storage of wine. In addition to it's antimicrobial properties, SO<sub>2</sub> is a Stone antioxidant. As an antioxidant, SO<sub>2</sub> prevents chemical oxidation by reacting with oxygen radicals. It inhibits the polyphenol oxidase enzyme from grapes and changes the oxidation pathway by reacting with oxidized components. As an antimicrobial, SO<sub>2</sub> inhibits undesirable microflora in the environment, and this effect varies depending on the pH of the environment. SO<sub>2</sub> ensures that the color of the wine is stable. In addition to all these positive properties, it is also known that SO<sub>2</sub> causes allergic reactions in some consumers. Increasing health concerns regarding the use of SO<sub>2</sub> have led to a widespread trend towards the use of SO<sub>2</sub> as an alternative and/or in combination with antimicrobial and antioxidant agents. Many studies are being carried out on using SO<sub>2</sub> in wine as an alternative or complementary to its protective effect. Dimethyl dicarbonate, bacteriocin, lysozyme, chitosan, and phenolic compounds are among the substances that can be used instead of or together with SO<sub>2</sub>. Additionally, this increase in consumer trends has led to the application of non-thermal technologies in wine production. Technologies that can deactivate microorganisms in wine are being researched. High hydrostatic pressure, ultraviolet radiation, and pulsed electric field are examples of non-thermal technologies that are being studied to be applied in wine for this purpose. The main purpose of the substance or method that can be an alternative to the use of SO<sub>2</sub> is to meet similar properties with SO<sub>2</sub> and preserve the sensory properties of the wine.

In this study, the applicability of alternative methods and technologies to minimize the use of SO<sub>2</sub> in wine production was examined.

I wish to acknowledge to Dimes Food Ind. and Inc. for their valuable supports to the study.

**Key Words:** Wine, SO<sub>2</sub>, alternative



## GENÇ YETİŞKİNLERİN KARIYER PLANLAMA BECERİLERİNİN KARIYER İYİMSERLİKLERİ VE İŞ UMUTLARI ÜZERİNDEKİ YORDAYICI ROLÜ

THE PREDICTIVE ROLE OF YOUNG ADULTS' CAREER PLANNING SKILLS ON THEIR CAREER OPTIMISM AND EMPLOYMENT HOPE

**Muhammet TORTUMLU**

Dr. Öğr. Üyesi, Burdur Mehmet Akif Ersoy Üniversitesi

ORCID NO: 0000-0002-7245-1017

**Kıvanç UZUN**

Dr. Öğr. Üyesi, Uşak Üniversitesi, (Sorumlu Yazar).

ORCID NO: 0000-0002-6816-1789

### ÖZET

Üniversite öğrenciliği döneminde olan genç yetişkinler için kariyer planlama becerisi oldukça önemlidir; çünkü bu beceri, gelecekte mesleklerine yönelik hangi alanda çalışacaklarını seçerken, kariyer hedeflerini belirlerken ve iş dünyasına hazırlanırken onlara rehberlik etmektedir. Genç yetişkinlerin kariyerlerine ilişkin olumlu algılarını ifade eden kariyer iyimserliklerinin ve iş umutlarının güçlendirilmesi, etkili kariyer planlama becerilerine sahip olmalarına bağlı olabilir. Bu düşünceden hareketle bu araştırmanın temel amacı, genç yetişkinlerin kariyer planlama becerileri ile kariyer iyimserlikleri ve iş umutları arasındaki ilişkinin saptanması ve genç yetişkinlerin sahip oldukları kariyer planlama becerisinin, kariyer iyimserlikleri ve iş umutları üzerinde anlamlı birer yordayıcı olup olmadığının belirlenmesidir. Bu amaç doğrultusunda, değişkenler arasındaki ilişkinin belirlenebilmesi için ilişkisel araştırma modeli kullanılmıştır. Çalışma grubu ise uygun örnekleme yöntemi ile oluşturulmuştur. Araştırmacılar tarafından hazırlanan çevrimiçi form, üniversite öğrencilerinin bulunduğu sosyal medya platformlarında paylaşılarak, genç yetişkinlik döneminde bulunan 403 katılımcıya (283 kadın ve 120 erkek) ulaşılmıştır. Katılımcıların yaş ortalaması 20.87'dir ( $\pm 2.77$ ). Araştırmada veriler, araştırmacılar tarafından oluşturulan demografik bilgi formu, Kariyer Planlama Ölçeği, Kariyer Geleceği Ölçeği ve İş Umudu Ölçeği kullanılarak toplanmıştır. Genç yetişkinlerin kariyer planlama becerileri ile kariyer iyimserlikleri ve iş umutları arasındaki ilişki pearson korelasyon katsayısı ve basit doğrusal regresyon analizleriyle incelenmiştir. Araştırmanın sonucunda, genç yetişkinlerin kariyer planlama becerileri ile kariyer iyimserlikleri ve iş umutları arasında pozitif yönde anlamlı ilişkiler bulunmuştur. Ayrıca genç yetişkinlerin, kariyer planlama becerisi düzeylerinin artmasının hem kariyer iyimserliklerini hem de iş umutlarını pozitif yönde yordadığı sonucuna ulaşılmıştır. Ulaşılan sonuçlar, genç yetişkinlerin





kariyer planlama becerilerinin desteklenmesi yoluyla kariyer iyimserliklerinin ve iş umutlarının artırılabilmesine ilişkin umut veren kanıtlar taşımaktadır.

**Anahtar Kelimeler:** Kariyer, Kariyer Planlama, Kariyer İyimserliği, İş Umudu, Genç Yetişkinler.

## ABSTRACT

Career planning skills are very important for young adults who are university students because this skill guides them in choosing the field they will work in the future, setting their career goals and preparing for the world of work. Strengthening young adults' career optimism and employment hopes, which express their positive perceptions of their careers, may depend on having effective career planning skills. Based on this idea, the main purpose of this study is to determine the relationship between young adults' career planning skills and their career optimism and employment hope and to determine whether young adults' career planning skills are significant predictors of their career optimism and employment hope. For this purpose, a relational research model was used to determine the relationship between the variables. The study group was formed by convenient sampling method. The online form prepared by the researchers was shared on social media platforms where university students are present, and 403 participants (283 female and 120 male) in young adulthood were reached. The average age of the participants was 20.87 ( $\pm 2.77$ ). The data were collected using a demographic information form created by the researchers, Career Planning Scale, Career Futures Inventory and Employment Hope Scale. The relationship between young adults' career planning skills and their career optimism and employment hope was examined using Pearson correlation coefficient and simple linear regression analysis. As a result of the study, significant positive relationships were found between young adults' career planning skills and their career optimism and employment hope. In addition, it was concluded that increasing the level of career planning skills of young adults positively predicted both their career optimism and employment hope. The results provide hope that young adults' career optimism and employment hopes can be increased by supporting their career planning skills.

**Keywords:** Career, Career Planning, Career Optimism, Employment Hope, Young Adults.

## GİRİŞ

Bugünün hızla değişen iş dünyasında, genç yetişkinlerin kariyerlerini başarıyla planlama ve yönlendirme becerileri giderek daha önemli bir hal almaya başlamıştır. Kariyer planlaması, bireylerin meslek seçiminden iş hedeflerine, eğitim gereksinimlerinden kişisel gelişimine kadar bir dizi kararı içeren karmaşık bir süreçtir. Genç yetişkinler için bu süreç, belirsizliklerle dolu olabilir



ve geleceğe dair belirli hedefler şekillendirmek zorlu bir görev haline gelebilir (Tortumlu ve Uzun, 2023). Sosyal Bilişsel Teori'nin (Bandura, 1986) kuramsal temellerine dayalı olarak ortaya çıkan Sosyal Bilişsel Kariyer Teorisi, bireylerin akademik ve kariyer ilgi alanlarının nasıl geliştiği, bu ilgi alanlarının diğer değişkenler ile birlikte kariyerle ilgili seçimleri nasıl teşvik ettiği ve insanların eğitim ve kariyer hedeflerine yönelik performans ve süreklilik düzeylerini nasıl elde ettiklerini incelemiştir (Lent, Brown ve Hackett, 1994). Hem Sosyal Bilişsel Teori hem de Sosyal Bilişsel Kariyer Teorisi, bireysel farklılıkların, iyimserlik ve umut gibi kişisel yatkınlıkların önemini özellikle vurgulamaktadır. Bu olumlu yönler, bir kişinin öz-yeterlik inançlarını ve geleceğe ilişkin beklentilerini somutlaştırmaya büyük ölçüde fayda sağlayan kariyer planlama becerilerinden etkilenebilir. İyimserlik, olumlu sonuçları beklemeye yönelik genelleştirilmiş bir eğilim veya bir kişinin yaşamında kötüden ziyade iyi şeylerin olacağına olan inancı olarak tanımlanabilir (Scheier ve Carver, 1993). Umut ve iyimserlik kavramları yakın anlamlı kavramlar gibi görünmelerine rağmen temelde birbirlerinden farklı anlamlar taşımaktadırlar. Umut, arzu edilen hedeflere ulaşmak için yollara ve motivasyona odaklanırken; iyimserlik ise gelecekteki olumlu sonuçlara ilişkin beklenti duyma ile ilgilidir (Santilli, Marcionetti, Rochat, Rossier ve Nota, 2017). Bryant ve Cvengros (2004) bu kavramları, geleceğe yönelimi yansıtan tek bir küresel boyutun ikili göstergeleri olarak değerlendirmişlerdir. Umut motivasyondan beslenebilen bir tutum iken, iyimserlik ise olaylara veya durumlara olumlu yaklaşımı ifade etmektedir.

Üniversite öğrenciliği döneminde olan genç yetişkinler için kariyer planlama becerisi oldukça önemlidir; çünkü bu beceri, gelecekte mesleklerine yönelik hangi alanda çalışacaklarını seçerken, kariyer hedeflerini belirlerken ve iş dünyasına hazırlanırken onlara rehberlik etmektedir. Kariyer planlama ve geliştirme süreci, öğrencilerin kendini tanıma, güçlü ve zayıf yönlerin tespiti, eğitim alma ve beceri geliştirme, kariyer hedeflerinin belirlenmesi, iş dünyasına hazırlık, kariyere uyum ve gelecek yaşamdaki mutluluklarında önemli bir etkidir. Kariyer planlama becerisi, bireylerin daha fazla öz-farkındalık yaşamasına imkân tanımaktadır (Soeprijanto, Diamah ve Rusmono, 2022). Öz-farkındalık, bireylerin kendilerini gerçekleştirebileceklerine olan inançlarını artıran önemli bir faktördür. Kendini geliştirebileceğini hissetmek hem kişisel eylemlilik anlamında hem de hedeflere yönelik belirli yollar arama anlamında bireylerin sahip olduğu motivasyona olumlu katkılarda bulunur (Bandura, 1997; Maddux ve Gosselin, 2003; Snyder, 2000) ve başarısızlık deneyimine rağmen iyimser ve geleceğe ilişkin umutlu bir bakış açısı ortaya çıkartabilir (Silvia ve O'Brien, 2004). Diğer taraftan Öz-Düzenleme Teorisi (Self-Regulation) bireysel hedeflere ulaşmak için zihinsel süreçleri, tutumları ve davranışları sistematik ve sıralı bir şekilde ayarlamının önemini özellikle vurgulamıştır (Zimmerman, 2002). Öğrenciler için öz-düzenleme süreci, düşüncelerini, eylemlerini ve sonuçlarını sürekli olarak amaçlarına ulaşmaya yönlendirdikleri bir süreç olarak tanımlanabilir (Schunk, Pintrich ve Meece, 2008). Akademik görevlerde başarılı sonuçlar ortaya



koymak, ilham ve planlamanın bir kombinasyonunu gerektirdiğinden, umut ve hedef belirleme döngüsünde çok önemli bir rol oynamaktadır (Feldman ve Kubota, 2015). Öz-farkındalık, geleceğe ilişkin planlar yapmak ve hedefler belirlemek öğrencilerde umut duygusunu güçlendirebilir ve yeteneklerine olan güvenlerini artırarak kariyerlerine ilişkin iyimser bir bakışı kazandırabilir. Umut vasıtasıyla öğrencilerin, akademik ortamlarını daha iyi düzenleyebilmeleri ve uzun vadede daha verimli bir yaşam sürmeleri beklenmektedir.

Üniversite öğrencilerinin kariyerlerine ilişkin olumlu algılarını ifade eden kariyer iyimserliklerinin ve iş umutlarının güçlendirilmesi, etkili kariyer planlama becerilerine sahip olmalarına bağlıdır. Kariyer planlama becerilerinin geliştirilmesinin ve desteklenmesinin, genç yetişkinlik döneminde yer alan üniversite öğrencilerinin kariyerlerini olumlu bir şekilde etkileyebileceği düşünülmektedir. Devamında ise kariyer iyimserliğine ve iş umuduna sahip olmak, bireylerin iş dünyasındaki başarılarını ve yaşam doyumlarını önemli ölçüde etkileyebilir. Kariyer iyimserliği, kişinin kariyer hedeflerine ulaşabileceğine duyduğu güveni yansıtırken, iş umudu ise gelecekteki iş fırsatlarına yönelik olumlu beklentileri ifade etmektedir. Bu iki faktör, bireylerin kariyerlerine duyduğu motivasyonu ve enerjiyi büyük ölçüde şekillendirebilir. Tüm bu teori, araştırma ve açıklamalar üniversite öğrencilerinin sahip oldukları kariyer planlama becerilerinin, iş umutlarını ve kariyer iyimserliklerini artıracak potansiyel bir değişken olarak ele alınabileceğini göstermektedir. Buradan hareketle bu araştırmanın temel amacı, genç yetişkinlerin kariyer planlama becerileri ile kariyer iyimserliği ve iş umudu düzeyleri arasındaki ilişkinin saptanması ve genç yetişkinlerin sahip oldukları kariyer planlama becerisinin kariyer iyimserlikleri ve iş umutları üzerinde anlamlı birer yordayıcı olup olmadığının belirlenmesidir. Bu amaç doğrultusunda şu araştırma sorularına cevap aranmıştır:

1. Genç yetişkinlerin sahip oldukları kariyer planlama becerileri ile kariyer iyimserlikleri ve iş umutları arasında anlamlı bir ilişki var mıdır?
2. Kariyer planlama becerisi, genç yetişkinlerin sahip oldukları kariyer iyimserliğinin anlamlı bir yordayıcısı mıdır?
3. Kariyer planlama becerisi, genç yetişkinlerin sahip oldukları iş umudunun anlamlı bir yordayıcısı mıdır?

## YÖNTEM

### Araştırmanın Modeli

Araştırmada genç yetişkinlerin kariyer iyimserliklerinin ve iş umutlarının, kariyer planlama becerileri açısından incelenmesine yönelik olarak ilişkisel araştırma modelinin kullanılması uygun bulunmuştur. İlişkisel araştırma modeli, nicel araştırmalar geleneğinin içerisinde yer alan bir



yaklaşımıdır ve amacı, iki veya daha fazla sayıda değişkenin arasındaki ilişkiyi inceleyerek, birlikte değişip değişmediklerini ve bu değişimin ölçüsünü belirlemektir (Karasar, 2012).

### **Çalışma Grubu**

Mevcut araştırmanın çalışma grubunu, 2022-2023 eğitim ve öğretim yılının güz döneminde Türkiye'deki bir devlet üniversitesinin çeşitli fakültelerinde öğrenim gören 403 gönüllü lisans öğrencisi oluşturmaktadır. Katılımcıların %70.20'si ( $n=283$ ) kadın, %29.80'i ( $n=120$ ) ise erkektir. Çalışma grubuna ilişkin yaş ortalaması ise 20.87 ( $\pm 2.77$ ) olarak belirlenmiştir. Çalışma grubunun oluşturulmasında, seçkisiz olmayan bir örnekleme yöntemi olan uygun örnekleme işe koşulmuştur. Uygun örnekleme, araştırmacıların, çalışmanın sağlıklı olarak sonuçlandırılabilmesi için gerekli olduğunu düşündükleri örneklem hacmine ulaşana kadar en kolay erişilebilecek olan katılımcılardan başlayarak çalışma grubunu oluşturdukları bir yöntemdir (Büyüköztürk, Kılıç-Çakmak, Akgün, Karadeniz ve Demirel, 2016).

### **Veri Toplama Araçları**

Araştırmaya ilişkin verileri toplamak amacıyla genç yetişkinlerin kişisel bilgilerinin sorulduğu demografik bilgi formu, Kariyer Planlama Ölçeği, Kariyer Geleceği Ölçeği ve İş Umudu Ölçeği işe koşulmuştur. Araştırma kapsamında işe koşulan tüm veri toplama araçları için telif hakkı sahibi olan yazarlardan, ölçeklerin bu araştırma kapsamında kullanılabilmesi için e-posta yoluyla yazılı izinler alınmıştır.

### **Demografik Bilgi Formu**

Çalışma grubundaki genç yetişkinlerin kişisel bilgilerine ulaşmak amacıyla, araştırmacılarca cinsiyet ve yaş bilgilerini içeren demografik bilgi formu hazırlanmıştır.

### **Kariyer Planlama Ölçeği (KPÖ)**

KPÖ, Gould (1979) tarafından bireylerin sahip oldukları kariyer planlama becerisi düzeylerini ölçmek için geliştirilmiş olup, Seçer (2013) tarafından Türk kültürüne uyarlanmıştır. Toplam 20 maddeden meydana gelen ölçek, 5'li Likert tipindedir. Ölçekte bulunan maddelerin puanlama skalası “[1] Kesinlikle katılmıyorum” ile “[5] Kesinlikle katılıyorum” arasındadır. KPÖ, “Kendini Değerlendirme” (1., 5., 10., 13. ve 16. maddeler), “Fırsatları Tanıma” (2., 6., 12., 15. ve 17. maddeler), “Hedefleri Belirleme” (3., 8., 9., 14. ve 20. maddeler) ve “Plan Oluşturma” (4., 7., 11., 18. ve 19. maddeler) şeklinde dört farklı alt boyuttan meydana gelmektedir. Ölçekten toplam bir bireysel kariyer planlama becerisi puanı da alınabilmektedir. Ölçekte ters puanlanan herhangi bir madde yer almamaktadır. Ölçeğin toplamından alınması muhtemel puanlar 20 ile 100 aralığında değişim göstermektedir. Ölçekten alınan puanın artması, bireyin sahip olduğu kariyer planlama becerisi düzeyinin de yükseldiğini ortaya koymaktadır. KPÖ için Cronbach Alpha iç tutarlılık



katsayısı ölçeğin bütünü için .94 olarak bulunmuştur (Sunman ve Oruç, 2022). Ölçeğin bu araştırma içerisinde kullanılabilirliğinin sınanması için yapı geçerliğinin kontrolünün sağlanması amacıyla doğrulayıcı faktör analizi (DFA), güvenilirlik değerinin tespit edilmesi için ise Cronbach Alpha iç tutarlılık analizi yapılmıştır. Bu analizler sonucunda KPÖ'ye yönelik ulaşılan değerlerin, alanyazında belirtilen geçerlik ( $\chi^2[n=403]=507.221$ ,  $sd=136$ ,  $p=.000$ ,  $\chi^2/sd=3.729$ , RMSEA=.078, SRMR=.065, CFI=.914) ve güvenilirlik (ölçeğin tümü için .88) referans aralığına uygun olduğu (Büyüköztürk, 2014; Kline, 2015) ve bu araştırma kapsamında kullanılabilmesi söylenebilir.

### ***Kariyer Geleceği Ölçeği (KARGEL)***

KARGEL, Rottinghaus, Day ve Borgen (2005) tarafından bireylerin sahip oldukları olumlu kariyer tutumlarını belirlemek için geliştirilmiş olup, Kalafat (2012) tarafından Türk kültürüne uyarlanmıştır. Toplamda 25 maddeden meydana gelen ölçek, 5'li Likert tipindedir. Ölçekte yer alan maddelerin puanlaması “[1] Kesinlikle katılmıyorum” ile “[5] Kesinlikle katılıyorum” arasındadır. KARGEL, “Kariyer Uyumluluğu” (1. ve 11. maddeler arası), “Kariyer İyimserliği” (12. ve 22. maddeler arası) ve “İş Piyasalarına İlişkin Algılanan Bilgi” (23. ve 25. maddeler arası) olmak üzere 3 farklı alt boyuttan meydana gelmektedir. Ölçeğin her bir alt boyutu ayrı ayrı kullanılabilmesi gibi, KARGEL'den genel bir kariyer tutumu puanı da alınabilmektedir. Ölçeğin kariyer uyumluluğu ve kariyer iyimserliği alt boyutlarından alınması muhtemel puanlar 11 ile 55 aralığında değişirken, iş piyasalarına ilişkin algılanan bilgi alt boyutundan alınması muhtemel puanlar 3 ile 15 aralığında değişmektedir. Ölçeğe ilişkin toplam puanlar ise 25 ile 125 aralığında değişim göstermektedir. Ölçeğin her bir alt boyutundan alınan yüksek puan bireyin ilgili alt boyutun değerlendirdiği özelliğe sahip olduğunu göstermektedir. Ölçekte yer alan 10., 11., 14., 15., 16., 19., 20. ve 24. maddeler ters olarak puanlanır. KARGEL için Cronbach Alpha iç tutarlılık katsayıları ise şu şekildedir: ölçeğin tamamı için .88, kariyer uyumluluğu alt boyutu için .83, kariyer iyimserliği alt boyutu için .82 ve iş piyasalarına ilişkin algılanan bilgi alt boyutu için .62 (Kalafat, 2012). Bu çalışma kapsamında, mevcut araştırmanın problem durumuna uygun olarak KARGEL'in sadece “Kariyer İyimserliği” alt boyutu kullanılmıştır. KARGEL'in kariyer iyimserliği alt boyutunun bu araştırma kapsamında kullanılabilirliğinin sınanması için yapı geçerliğini kontrol etmek amacıyla DFA, güvenilirlik değerinin tespit edilmesi için ise Cronbach Alpha iç tutarlılık analizi gerçekleştirilmiştir. Bu analizler sonucunda KARGEL'in kariyer iyimserliği alt boyutuna yönelik ulaşılan değerlerin, alanyazında belirtilen geçerlik ( $\chi^2[n=403]=115.727$ ,  $sd=35$ ,  $p=.000$ ,  $\chi^2/sd=3.306$ , RMSEA=.072, SRMR=.066, CFI=.940) ve güvenilirlik (.81) referans aralığına uygun olduğu (Büyüköztürk, 2014; Kline, 2015) ve bu araştırma kapsamında kullanılabilmesi söylenebilir.



### ***İş Umudu Ölçeği (İÜÖ)***

İÜÖ, Hong, Polanin ve Pigott (2012) tarafından üniversitede öğrenim görmekte olan gençlerin mezun olduktan sonra iş bulmaya yönelik umutlarını ölçmek amacıyla geliştirilmiştir. Ölçeğin Türk Kültürüne uyarlama çalışmaları ise Akın, Hamedoğlu, Kaya ve Sarıçam (2013) tarafından gerçekleştirilmiştir. Toplamda 14 maddeden oluşan ölçek, 11’li Likert tipi puanlamalıdır. Ölçekte yer alan maddelerin puanlanması “[0] Kesinlikle katılmıyorum, [5] Nötr ve [11] Kesinlikle katılıyorum” aralığında değişmektedir. İÜÖ, “Psikolojik Güçlendirme” (1., 2., 3. ve 4. maddeler) ve “Amaç Yönelimli Yol” (5., 6., 7., 8., 9., 10., 11., 12., 13. ve 14. maddeler) olmak üzere iki alt boyuttan oluşmaktadır. Ölçekte tersten puanlanan madde bulunmamaktadır. Ölçek toplam bir iş umudu puanı da vermektedir. Ölçekten alınan toplam puan 0 ila 154 aralığında değişmektedir. Ölçekten alınan puan yükseldikçe bireylerin üniversite mezuniyeti sonrasında iş bulmaya yönelik umutlarının da arttığı kabul edilmektedir. İÜÖ, Cronbach Alpha iç tutarlılık katsayısı ölçeğin tümü için .93 olarak hesaplanmıştır (Akın vd., 2013). İÜÖ’nün bu araştırma kapsamında kullanılabilirliğinin sınanması için yapı geçerliğini kontrol etmek amacıyla DFA, güvenilirlik değerinin tespit edilmesi için ise Cronbach Alpha iç tutarlılık analizi gerçekleştirilmiştir. Bu analizler sonucunda İÜÖ’ye yönelik ulaşılan değerlerin, alanyazında belirtilen geçerlik ( $\chi^2[n=403]=254.721$ ,  $sd=71$ ,  $p=.000$ ,  $\chi^2/sd=3.587$ ,  $RMSEA=.079$ ,  $SRMR=.064$ ,  $CFI=.945$ ) ve güvenilirlik (ölçeğin tümü için .91) referans aralığına uygun olduğu (Büyüköztürk, 2014; Kline, 2015) ve bu araştırma kapsamında kullanılabileceği söylenebilir.

### **Verilerin Toplanması**

Demografik bilgi formunun yanında üç ayrı ölçme aracını içeren uygulama formu, veri setinin hızlı bir şekilde toplanması amacıyla Google Formlar platformu kullanılarak çevrimiçi bir form şeklinde hazırlanmıştır. Ardından, hazırlanan çevrimiçi form, verilerin toplandığı devlet üniversitesinde araştırmacıların kolaylıkla ulaşabilecekleri fakülteler için ayrı ayrı kurulmuş olan ve öğrencilerin haberleşmelerini kolaylaştırmak amacıyla kullanılmakta olan Whatsapp gruplarında paylaşılmıştır. Çevrimiçi formdaki giriş bölümünde, araştırmanın içeriğine ve kullanılan ölçeklere dair gerek görülen açıklamalar, katılımcıların bilgisine sunulmuştur. Ardından, çevrimiçi ortamda “Açıklamayı okudum. Çalışmanın amacını anladım. Bu çalışmaya katılmayı gönüllü olarak kabul ediyorum.” beyanına onay veren katılımcılar araştırmanın veri toplama süreci içerisine dahil olmuştur.

### **Verilerin Analizi**

Verilerin istatistiksel analizlerinin yapılması için toplanan 416 veri seti öncelikle SPSS 22.0 programına işlenmiştir. Veriler sanal ortamda toplandığından formun başarıyla tamamlanıp gönderilebilmesi için katılımcıların çevrimiçi anket formundaki tüm soruları eksiksiz bir şekilde



cevaplandırmaları gereklidir. Bu şekilde, katılımcılarca doldurularak araştırmacılara ulaştırılan formlardaki değerlerin tamamı, olası sınırlar içerisinde kalmış ve kayıp olan herhangi bir veri içermemiştir. Buradan hareketle araştırmanın mevcut veri setinde, kayıp verilerin incelenmesi ve kayıp değerlerin atanması işlemleri yapılmamıştır.

Mevcut veri seti içerisinde bulunan uç değerleri belirlemek için tek ve çok değişkenli uç değer incelemeleri yapılmıştır. Öncelikle, tek değişkenli uç değerlerin incelenmesi için Z testi uygulanmış, çalışma grubunda bulunan kişi sayısının 100'den çok olması nedeniyle Z puanının kabul edilen referans değer aralığı -4.00 ile +4.00'dür (Mertler ve Vannatta, 2016). Nitekim -4.00 ile +4.00 aralığı dışında kalan standartlaştırılmış Z puanına sahip 12 katılımcının verileri çalışmadan çıkarılmıştır. Sonrasında ise çok değişkenli uç değerlerin incelenmesinin yapılabilmesi adına Mahalonobis uzaklık katsayısı hesaplanmış ve veri seti içerisinde bulunan 1 katılımcının verisi, uç değer göstermesinden dolayı çalışmanın dışında bırakılmıştır (Tabachnick ve Fidell, 2013). Toplam olarak 13 katılımcının verileri yapılacak analizlerin dışarısında bırakılmış ve geriye kalan bütün analizler uç değer ifade etmeyen 403 katılımcıya ait veriler kullanılarak yürütülmüştür.

Araştırma kapsamında kullanılacak olan verilerin, yapılacak analizler için hazırlanmasından sonra, Kariyer Planlama Ölçeği'nin, Kariyer Geleceği Ölçeği'nin kariyer iyimserliği alt boyutunun ve İş Umudu Ölçeği'nin bu araştırma içerisinde kullanılabilirliğinin belirlenmesi adına geçerliliğine ve güvenilirliğine bakılmıştır. Kullanılan ölçeklerin geçerliklerinin sınanması için yapılan DFA analizi AMOS 21.0 programının kullanılmasıyla gerçekleştirilmiş; güvenilirliklerinin sınanması amacıyla yapılan Cronbach Alpha iç tutarlık katsayısı analizi ise SPSS 22.0 programıyla yapılmıştır. Ulaşılan sonuçlar, ölçeklerin mevcut araştırma içerisinde kullanılabilir seviyede geçerliğe ve güvenilirliğe sahip olduklarını ortaya koymaktadır. Ölçeklere ilişkin ulaşılan geçerlik ve güvenilirlik değerleri, mevcut araştırma içerisinde yer alan veri toplama araçları başlığı altında ayrıntılı bir biçimde verilmiştir.

Bu çalışmada, genç yetişkinlerin kariyer planlama becerisi düzeylerinin kariyer iyimserliklerini ve iş umutlarını ne derecede ve ne yönde yordadığını saptamak adına iki ayrı basit doğrusal regresyon analizi gerçekleştirilmiştir. Regresyon analizi, bağımlı değişkenin (tahmin edilen değişken) kendisiyle ilişkili olduğu öne sürülen bir veya daha fazla bağımsız değişken (tahmin edici değişken) temel alınarak tahmin edilmesini sağlayan bir analizdir (Büyüköztürk, 2014). Regresyon analizinin gerçekleştirilebilmesi adına bazı temel varsayımlar karşılanmalıdır. Bu bağlamda, veri seti içerisinde bulunan sürekli değişkenlerin her birinin normallik varsayımını karşılayıp karşılamadığı, çoklu bağlantı sorununun yaşanıp yaşanmadığı incelenmiş ve bağımlı değişkenlere ilişkin otokorelasyon değerleri belirlenmeye çalışılmıştır.



Mevcut araştırmanın kapsamında yer alan tüm sürekli değişkenler için hesaplanmış olan çarpıklık ve basıklık katsayıları -1.00 ile +1.00 arasında olmasından yola çıkılarak, veri setinin normal dağılımdan önemli ölçüde sapmadığı söylenebilir (Çokluk, Şekercioğlu ve Büyüköztürk, 2014). Bu nedenle araştırma kapsamında işlenen verilerin, normal dağılım varsayımını sağladığı ifade edilebilir (Bkz. Tablo-1). Veri seti içerisinde çoklu bağlantı probleminin bulunup bulunmadığının kontrol edilmesi amacıyla değişkenlerin arasındaki basit (ikili) korelasyonlar incelenmiştir. Gerçekleştirilen analizler neticesinde değişkenlerin arasında hesaplanan ikili korelasyon değerlerinin tümünün, referans değeri olarak belirlenen .90'dan (Çokluk vd., 2014) düşük olduğu tespit edilmiştir (Bkz. Tablo-2). Bu çerçevede, araştırmanın değişkenleri arasında çoklu bağlantı sorununun olmadığı söylenebilir. Son aşamada, bağımlı değişkenlerden her biri için otokorelasyon değerleri (Durbin Watson testi) hesaplanmış ve kariyer iyimserliği için 1.811, iş umudu için ise 1.928 olarak tespit edilmiştir. Tabachnick ve Fidell (2013) tarafından belirtildiği üzere, hataların birbirinden bağımsız olduğunun söylenebilmesi için Durbin Watson testi sonucunun 1.50 ile 2.50 aralığında bulunması gerekmektedir, bu bağlamda ulaşılan değerlerin regresyon analizlerinin yapılabilmesi için kabul edilebilecek seviyede olduğu ifade edilebilir. Bütün bu adımların sonucu olarak mevcut verilerin, planlanan regresyon analizleri için gerekli olduğu düşünülen tüm varsayımları karşıladığı ifade edilebilir. Buradan hareketle araştırmanın alt problemlerine cevap bulabilmek için değişkenlerin arasında bulunan ilişkinin belirlenebilmesi adına pearson korelasyon katsayısı analizi; kariyer planlama becerisinin, genç yetişkinlerin kariyer iyimserliklerini ve iş umutlarını ne derece yordadığının anlaşılabilmesi için ise iki farklı basit doğrusal regresyon analizi uygulanmıştır. Tüm bu istatistiksel analizlerin tamamı SPSS 22.0 programında yapılmakla beraber anlamlılık düzeyi olarak .05 kabul edilmiştir.

## BULGULAR

Araştırmada cevap aranan alt problemler ile ilgili elde edilen bulguların sunulmasına geçilmeden önce kariyer planlama becerisi, kariyer iyimserliği ve iş umudu değişkenleri için hesaplanmış olan betimleyici istatistiklerin sonuçları, Tablo-1'de verilmiştir.

**Tablo 1.** Araştırma Değişkenlerine İlişkin Betimsel İstatistikler

Değişkenler	<i>n</i>	Ranj	Min.	Max.	$X_{ort}$	$\bar{x}$	<i>ss</i>	Çarpıklık	Basıklık
Kariyer Planlama Becerisi	403	58.00	42.00	100.00	80.00	79.16	10.55	-.339	-.098
Kariyer İyimserliği	403	36.00	19.00	55.00	39.00	39.42	7.11	-.117	-.250
İş Umudu	403	107.00	47.00	154.00	129.00	126.96	20.68	-.761	.455

Araştırma kapsamında incelenen verilerin, normal dağılım varsayımını değerlendirmek amacıyla Tablo-1'de bulunan çarpıklık ve basıklık katsayıları ele alındığında; araştırmadaki tüm sürekli





değişkenler için hesaplanan çarpıklık ve basıklık katsayılarının, referans değer aralığı olarak kabul edilen -1.00 ile +1.00 arasında (Çokluk vd., 2014) olduğu anlaşılmaktadır. Buradan hareketle araştırma kapsamında yer alan tüm değişkenlerin, normal dağılım varsayımını sağlandığı ifade edilebilir. Ayrıca Kariyer Planlama Ölçeği'nden en düşük 20 en fazla ise 100 puanın alınabileceği bilindiğine göre katılımcı genç yetişkinlerin kariyer planlama becerisi puan ortalaması ( $\bar{x}=79.16$ ), hesaplanan ortanca (medyan) puanın ( $X_{ort}=80.00$ ) çok az altında kaldığı ifade edilebilir. Diğer yandan Kariyer Geleceği Ölçeği'nin kariyer iyimserliği alt boyutundan en düşük 11 en fazla ise 55 puanın alınabildiği göz önünde bulundurulduğunda; katılımcı genç yetişkinlerin kariyer iyimserlikleri puan ortalamasının ( $\bar{x}=39.42$ ), ortanca puanın ( $X_{ort}=39.00$ ) çok az üstünde olduğu anlaşılmaktadır. Son olarak, İş Umudu Ölçeği'nden en düşük 0 en fazla ise 154 puanın alınabileceği göz önünde tutulduğunda; genç yetişkinlerin iş umudu puan ortalamasının ( $\bar{x}=126.96$ ), hesaplanan ortanca puanın ( $X_{ort}=129.00$ ) çok az altında kaldığı görülmektedir.

Araştırmanın birinci alt problemini çözmek amacıyla genç yetişkinlerin kariyer planlama becerileri ile kariyer iyimserliği ve iş umudu puanlarının arasında istatistiksel açıdan anlamlı ilişkilerin bulunup bulunmadığını ve bu ilişkilerin düzeylerinin belirlenmesi adına pearson momentler çarpımı korelasyon katsayısı analizi işe koşularak, değişkenlerin arasında bulunan ikili korelasyon değerleri incelenmiştir. Değişkenlerin arasında bulunan ikili korelasyon değerlerine ilişkin sonuçlar, Tablo-2'de gösterilmektedir.

**Tablo 2.** Değişkenler Arası Pearson Momentler Çarpımı Korelasyon Katsayısı

Değişkenler	Kariyer Planlama Becerisi	Kariyer İyimserliği	İş Umudu
Kariyer Planlama Becerisi	1.00		
Kariyer İyimserliği	.619*	1.00	
İş Umudu	.633*	.587*	1.00

\* $p<.05$

Tablo-2 incelendiğinde, genç yetişkinlerin kariyer planlama becerileri ile kariyer iyimserlikleri ( $r=.619$ ,  $p<.05$ ) ve iş umutları ( $r=.633$ ,  $p<.05$ ) arasında pozitif yönde anlamlı ilişkilerin olduğu anlaşılmaktadır. Ayrıca elde edilen korelasyon katsayısı incelendiğinde, genç yetişkinlerin kariyer planlama becerileri ile kariyer iyimserlikleri ve iş umutları arasında orta düzeyde ( $.30<r<.70$ ) bir ilişkinin var olduğu görülmektedir (Büyüköztürk, 2014). Diğer yandan tüm bu ilişkilerin, planlanan regresyon modellerinde çoklu bağlantı problemi oluşturabilecek seviyede bulunmadığı ( $r<.90$ ) ifade edilebilir (Çokluk vd., 2014).



ATLAS 11. INTERNATIONAL  
CONGRESS ON ADVANCED SCIENTIFIC STUDIES AND INTERDISCIPLINARY RESEARCH

Araştırmanın ikinci alt problemi olan genç yetişkinlerin sahip oldukları kariyer planlama becerisinin kariyer iyimserliklerini ne ölçüde yordadığını belirlemek için basit doğrusal regresyon analizi yapılmıştır. Yapılan basit doğrusal regresyon analizine ait bulgular Tablo-3'te sunulmuştur.

**Tablo 3.** *Genç Yetişkinlerin Kariyer İyimserliklerinin Yordayıcısı Olarak Kariyer Planlama Becerisi*

Yordayıcı Değişken	B	SH <sub>(B)</sub>	$\beta$	t	p
Sabit	6.427	2.112	-	3.044	.002*
Kariyer Planlama Becerisi	.417	.026	.619	15.766	.000*

R=.619 R<sup>2</sup>=.383 F=248.552 sd=1/401 p=.000 Durbin Watson=1.811

\*p<.05

Tablo-3'te görülen basit doğrusal regresyon analizi sonuçlarına göre kariyer planlama becerisi düzeyleri, genç yetişkinlerin kariyer iyimserliklerini istatistiksel olarak anlamlı bir şekilde yordamakta ve regresyon için kurgulanan modelin anlamlı olduğu görülmektedir [R=.619, R<sup>2</sup>=.383, F<sub>(1-401)</sub>=248.552, p<.05]. Kariyer planlama becerisi, genç yetişkinlerin kariyer iyimserliği puanlarındaki değişkenliğin %38.30'unu açıklamaktadır. Bu bağlamda kariyer planlama becerisi düzeylerinin, genç yetişkinlerin kariyer iyimserlikleri üzerinde büyük oranda (.26<R<sup>2</sup>) etki değerine sahip olduğu söylenebilir (Cohen, 1988). Regresyon katsayılarının anlamlılığına ilişkin t-testi sonuçları incelendiğinde ise kariyer planlama becerisi düzeyinin, genç yetişkinlerin kariyer iyimserlikleri üzerinde pozitif yönde (t=15.766, p<.05) anlamlı bir yordayıcı olduğu görülmektedir. Bu bulgular göz önüne alındığında genç yetişkinlerin, kariyer planlama becerisi puanlarının artmasıyla birlikte kariyer iyimserliklerinin de buna bağlı olarak artabileceği söylenebilir.

Araştırmanın üçüncü alt problemi olan genç yetişkinlerin sahip oldukları kariyer planlama becerisinin iş umutlarını ne ölçüde yordadığını belirlemek için basit doğrusal regresyon analizi yapılmıştır. Yapılan basit doğrusal regresyon analizine ait bulgular Tablo-4'te sunulmuştur.

**Tablo 4.** *Genç Yetişkinlerin İş Umutlarının Yordayıcısı Olarak Kariyer Planlama Becerisi*

Yordayıcı Değişken	B	SH <sub>(B)</sub>	$\beta$	t	p
Sabit	28.742	6.052	-	4.750	.000*
Kariyer Planlama Becerisi	1.241	.076	.633	16.374	.000*

R=.633 R<sup>2</sup>=.401 F=268.093 sd=1/401 p=.000 Durbin Watson=1.928

\*p<.05

Tablo-4'te görülen basit doğrusal regresyon analizi sonuçlarına göre kariyer planlama becerisi düzeyleri, genç yetişkinlerin iş umutlarını istatistiksel olarak anlamlı bir şekilde yordamakta ve regresyon için kurgulanan modelin anlamlı olduğu görülmektedir [R=.633, R<sup>2</sup>=.401, F<sub>(1-401)</sub>=



268.093,  $p<.05$ ]. Kariyer planlama becerisi, genç yetişkinlerin iş umudu puanlarındaki değişkenliğin %40.10'unu açıklamaktadır. Bu bağlamda kariyer planlama becerisi düzeylerinin, genç yetişkinlerin iş umutları üzerinde büyük oranda ( $.26 < R^2$ ) etki değerine sahip olduğu söylenebilir (Cohen, 1988). Regresyon katsayılarının anlamlılığına ilişkin t-testi sonuçları incelendiğinde ise kariyer planlama becerisi düzeyinin, genç yetişkinlerin iş umutları üzerinde pozitif yönde ( $t=16.374, p<.05$ ) anlamlı bir yordayıcı olduğu görülmektedir. Bu bulgular göz önüne alındığında genç yetişkinlerin, kariyer planlama becerisi puanlarının artmasıyla birlikte iş bulmaya yönelik umutlarının da buna bağlı olarak artabileceği söylenebilir.

### TARTIŞMA VE SONUÇ

İş umudu ve kariyer iyimserliği, bireylerin iş hayatında başarılı olma ve kişisel tatmin elde etme konusundaki olumlu inançlarını ifade etmektedir. Bu olumlu inançlar, bireylerin motivasyonlarını artırabilir, zorluklarla başa çıkılmalarını kolaylaştırabilir ve genel yaşam memnuniyetlerine katkıda bulunabilir. Nitekim yapılan birçok araştırma umut, iyimserlik ve sosyal desteğin öğrencilerin başarılarını etkilediğini göstermektedir (Bamum, Snyder, Rapoff, Mani ve Thompson, 1998; Juntunen ve Wettersten, 2006; Katz, 2002; Rogerson-Revell, 2007; Westburg ve Martin, 2003). Bu bağlamda genç yetişkin bireylerin sağlıklı bir kariyer süreci geçirebilmeleri için gerekli olan iş umudu ve kariyer iyimserliği gibi inançlarının desteklenmesi adına birtakım önleyici ve eğitici çalışmaların yapılması ihtiyacı hissedilmiştir. Öncelikli olarak öğrencilerin kariyer süreçlerine ilişkin olumlu bir inanca sahip olmaları için gerekli olan bu özellikleri destekleyebilecek becerilerin belirlenmesi bu aşamada önem kazanmaktadır. Nitekim bu araştırmada genç yetişkinlik döneminde bulunan üniversite öğrencilerinin iş umutları ve kariyer iyimserlikleri üzerinde önemli bir belirleyici olabileceği düşünülen kariyer planlama becerisine odaklanılmıştır.

Mevcut araştırmanın sonucunda, kariyer planlama becerisinin üniversite öğrencilerinin iş umudunu ve kariyer iyimserliklerini pozitif yönde ve önemli ölçüde etkilediği görülmüştür. Diğer bir deyişle üniversite öğrencilerinin kariyer planlama becerileri geliştirildiğinde, buna bağlı olarak iş umutları ve kariyerlerine yönelik iyimserlikleri de artmaktadır. Bugün Türkiye'deki üniversitelerde kariyer planlama ve geliştirme eğitimleri çeşitli müdahale programları ile öğrencilere verilmektedir (Tortumlu ve Uzun, 2023). Nitekim Bandura (1997) deneyimsel bir öğrenmenin, ilgili konuya yönelik öz-yeterlik oluşturmaya yardımcı olabileceğini ifade etmiştir. Kariyer planlama becerisi de öz-değerlendirme ve kendini keşfetme sürecini artırarak, profesyonel çevreyi tanıyarak, geleceği tasarlayarak ve kendini eylem için hazırlayarak kariyer sürecine ilişkin öz-yeterlik inancını artırmaktadır (Tarigan ve Wimbari, 2011). Üniversite öğrencilerinin kariyerlerini planlamaya yönelik yaptıkları tüm bu hazırlıklar, iş umudu ve kariyer iyimserliği gibi geleceğe dair olumlu yaklaşımlarını artırmaktadır. Kariyer planlama becerisine sahip olan bireyler, kısa vadeli ve uzun



vadeli hedefler belirleme konusunda daha başarılıdır. Bu hedefler ise bireylerin kişilik, yetenek ve zekâ türü bağlamında tüm özelliklerini dikkate alarak gelecekte ne tür işlerde çalışmak istedikleri, hangi becerilere sahip olmak istedikleri ve hangi kariyer yollarını izlemek istedikleri gibi konularla ilgilidir. Nitekim hedefler belirlemek, iş umudu ve kariyer iyimserliğini artırabilir. Zira bireyler belirledikleri hedeflere ulaşacaklarına olan inançlarıyla motive olurlar.

### **Öneriler**

Bu araştırmanın sonucunda genç yetişkinlik döneminde bulunan üniversite öğrencileri için oldukça olumlu ve önemli bulgular elde edilmiştir. Araştırma kapsamında genç yetişkinlerin kariyer planlama becerileri, kariyer iyimserlikleri ve iş umutları arasında güçlü ve pozitif bir ilişkinin olduğu anlaşılmıştır. Ayrıca genç yetişkinlerin kariyer planlama becerilerinin desteklenmesi ile kariyer iyimserliklerinin ve iş umutlarının artırılabilmesine ilişkin umut veren sonuçlar elde edilmiştir. Tüm bu sonuçlardan yola çıkarak, genç yetişkinlerin kariyer planlama becerilerini desteklemek ve güçlendirmek için çeşitli stratejiler ve müdahale programları geliştirilebilir. Örneğin, üniversitelerin bünyelerinde kariyer geliştirme, uygulama ve araştırma merkezleri kurularak, öğrencilere sunulan bireysel kariyer danışmanlık hizmetlerinin yaygınlaştırılması sağlanabilir. Bu yol ile genç yetişkinlere, kariyer planlama becerilerini güçlendirebilmeleri için kişisel özellikleri, kaynakları ve hedefleri dikkate alınarak bireye özgü rehberlik yapılabilir. Ayrıca Millî Eğitim Bakanlığına bağlı okullarda ve üniversitelerde, kariyer planlama derslerinin konulması ve içeriğinin güçlendirilmesi, genç yetişkinlerin meslek ve iş seçimi konusundaki farkındalıklarını artırabilir ve kariyer planlama süreçlerini destekleyebilir. Halihazırda üniversitelerde seçmeli ders olarak verilen kariyer planlama dersi tüm öğrenciler için zorunlu tutulabilir ve içerikleri zenginleştirilebilir. Ayrıca bu içerikler, teorik bilgiye ek olarak öz-farkındalığı artırmaya yönelik çeşitli müdahale programları geliştirilerek de desteklenmelidir. Bu bağlamda iş umudunun ve kariyer iyimserliğinin artırılmasına hizmet edecek ve içeriği kariyer planlama becerisi kazanmaya yönelik düzenlenmiş psikoeğitim programları geliştirilebilir. Üniversitelerin kariyer merkezlerinin planlamaları doğrultusunda bu programlar, öğrencilere 6 ila 8 oturum arasında 12 ila 14 kişilik gruplar halinde uygulanabilir. Büyük gruplara ise iş umudu ve kariyer iyimserliğiyle ilgili seminerler planlanarak, kariyer planlama becerisinin bu süreçteki kritik rolü hakkında kısa sürede yüzeysel bilgilendirmeler yapıp bu konuda farkındalık oluşturulabilir.



## KAYNAKÇA

- Akın, A., Hamedoğlu, M. A., Kaya, Ç., & Sarıçam H. (2013). İş Umudu Ölçeği (İÜÖ) Türkçe Formu: Geçerlik ve güvenilirlik çalışması. *İİB International Refereed Academic Social Sciences Journal*, 11, 56-68.
- Bamum, D. D., Snyder, C. R., Rapoff, M. A., Mani, M. M., & Thompson, R. (1998). Hope and social support in the psychological adjustment of children who have survived bum injuries and their matched controls. *Children's Health Care*, 27(1), 15-30.
- Bandura, A. (1986). *Social foundations of thought and action: A social cognitive theory*. Englewood Cliffs, NJ: Prentice Hall.
- Bandura, A. (1997). *Self-efficacy: The exercise of control*. New York: Freeman.
- Bryant, F. B., & Cvengros, J. A. (2004). Distinguishing hope and optimism: Two sides of a coin, or two separate coins? *Journal of Social and Clinical Psychology*, 23(2), 273-302. <https://doi.org/10.1521/jscp.23.2.273.31018>
- Büyüköztürk, Ş. (2014). *Sosyal bilimler için veri analizi el kitabı* (19.Basım). Ankara: Pegem Akademi.
- Büyüköztürk, Ş., Kılıç-Çakmak, E., Akgün, Ö.E., Karadeniz, Ş., & Demirel, F. (2016). *Bilimsel araştırma yöntemleri* (21.Basım). Ankara: Pegem Akademi.
- Cohen, J. (1988). *Statistical power analysis for the behavioral sciences* (2.Basım). Hillsdale, NJ: Erlbaum.
- Çokluk, Ö., Şekercioğlu, G., & Büyüköztürk, Ş. (2014). *Sosyal bilimler için çok değişkenli istatistik SPSS ve LISREL uygulamaları* (3.Basım). Ankara: Pegem Akademi.
- Feldman, D. B., & Kubota, M. (2015). Hope, self-efficacy, optimism, and academic achievement: Distinguishing constructs and levels of specificity in predicting college grade-point average. *Learning and Individual Differences*, 37, 210-216. <https://doi.org/10.1016/j.lindif.2014.11.022>
- Field, A. (2009). *Discovering statistics using SPSS* (3.Basım). London: Sage Publications Ltd.
- Gould, S. (1979). Characteristics of career planners in upwardly mobile occupations. *The Academy of Management Journal*, 22(3), 539-550. <https://doi.org/10.5465/255743>
- Hong, P. Y. P., Polanin, J. R., & Pigott, T. D. (2012). Validation of the employment hope scale: Measuring psychological self-sufficiency among low-income jobseekers. *Research on Social Work Practice*, 22(3), 323-332.



- Juntunen, C. L., & Wettersten, K. B. (2006). Work hope: Development and initial validation of a measure. *Journal of Counseling Psychology*, 53(1), 94-106. <https://doi.org/10.1037/0022-0167.53.1.94>
- Kalafat, T. (2012). Kariyer Geleceği Ölçeği (KARGEL): Türk örnekleme için psikometrik özelliklerinin İncelenmesi. *Türk Psikolojik Danışma ve Rehberlik Dergisi*, 4(38), 169-179.
- Karasar, N. (2012). *Bilimsel araştırma yöntemi* (24.Basım). Ankara: Nobel Yayın Dağıtım.
- Katz, Y. J. (2002). Attitudes affecting college students' preferences for distance learning. *Journal of Computer Assisted Learning*, 18(1), 2-9. <https://doi.org/10.1046/j.0266-4909.2001.00202.x>
- Kline, R. B. (2015). *Principles and practice of structural equation modeling* (4.Basım). New York: Guilford Publications.
- Lent, R. W., Brown, S. D., & Hackett, G. (1994). Toward a unifying social cognitive theory of career and academic interest, choice, and performance. *Journal of Vocational Behavior*, 45(1), 79-122. <https://doi.org/10.1006/jvbe.1994.1027>
- Maddux, J. E., & Gosselin, J. T. (2003). Self-efficacy. M. R. Leary & J. P. Tangney (Ed.), *Handbook of self and identity* içinde (ss. 218-238). New York: Guilford.
- Mertler, C. A., & Vannatta, R. A. (2016). *Advanced and multivariate statistical methods: Practical application and interpretation* (6.Basım). CA: Pyrczak Publishing.
- Rogerson-Revell, P. (2007). Directions in e-learning tools and technologies and their relevance to online distance language education. *Open Learning: The Journal of Open, Distance and e-Learning*, 22(1), 57-74. <https://doi.org/10.1080/02680510601100168>
- Rottinghaus, P. J., Day, S. X., & Borgen, F. H. (2005). The Career Futures Inventory: A measure of career-related adaptability and optimism. *Journal of Career Assessment*, 13(1), 3-24. <https://doi.org/10.1177/1069072704270271>
- Santilli, S., Marcionetti, J., Rochat, S., Rossier, J., & Nota, L. (2017). Career adaptability, hope, optimism, and life satisfaction in Italian and Swiss adolescents. *Journal of Career Development*, 44(1), 62-76. <https://doi.org/10.1177/0894845316633793>
- Scheier, M. F., & Carver, C. S. (1993). On the power of positive thinking: The benefits of being optimistic. *Current Directions in Psychological Science*, 2(1), 26-30. <https://doi.org/10.1111/1467-8721.ep10770572>



- Schunk, D. H., Pintrich, P. R., & Meece, J. L. (2008). *Motivation in education* (3.Basım). Columbus, Ohio: Pearson Merrill Prentice Hall.
- Seçer, H. (2013). *Bireysel kariyer planlama ve kişisel başarı algısı arasındaki ilişki ve Pamukkale Üniversitesi'nde bir araştırma* (Yayımlanmamış yüksek lisans tezi). Pamukkale Üniversitesi, Sosyal Bilimler Enstitüsü, Denizli.
- Silvia, P. J., & O'Brien, M. E. (2004). Self-awareness and constructive functioning: Revisiting "the human dilemma". *Journal of Social and Clinical Psychology*, 23(4), 475-489. <https://doi.org/10.1521/jscp.23.4.475.40307>
- Snyder, C. R. (2000). The past and possible futures of hope. *Journal of Social and Clinical Psychology*, 19(1), 11-28. <https://doi.org/10.1521/jscp.2000.19.1.11>
- Soeprijanto, S., Diamah, A., & Rusmono, R. (2022). The effect of digital literacy, self-awareness, and career planning on engineering and vocational teacher education students' learning achievement. *JOTSE*, 12(1), 172-190. <http://dx.doi.org/10.3926/jotse.1434>
- Sunman, G., & Oruç, Ş. (2022). Öz saygının bireysel kariyer planlama ve akademik güdülenme üzerine etkisi: Üniversite öğrencileri üzerine bir çalışma. *İşletme Akademisi Dergisi*, 3(2), 229-247. <https://doi.org/10.26677/TR1010.2022.1029>
- Tabachnick, B. G., & Fidell, L. S. (2013). *Using multivariate statistics*. Boston: Pearson.
- Tarigan, M., & Wimbari, S. (2011). Career planning program to increase career search self efficacy in fresh graduates. *Journal of Higher Education Theory and Practice*, 11(4), 75-87.
- Tortumlu, M., & Uzun, K. (2023). Üniversite öğrencileri için geliştirilen kariyer planlamaya yönelik çevrimiçi müdahale programının etkililiğinin incelenmesi. *Fırat Üniversitesi Sosyal Bilimler Dergisi*, 33(3), 1281-1298. <https://doi.org/10.18069/firatsbed.1262883>
- Westburg, N. G., & Martin, D. (2003). The Relationship between a child's hope, a parent's hope, and student-directed, goal-oriented academic instruction. *The Journal of Humanistic Counseling, Education and Development*, 42(2), 152-164. <https://doi.org/10.1002/j.2164-490X.2003.tb00003.x>
- Zimmerman, B. J. (2002). Becoming a self-regulated learner: An overview. *Theory Into Practice*, 41(2), 64-70. [https://doi.org/10.1207/s15430421tip4102\\_2](https://doi.org/10.1207/s15430421tip4102_2)



## CARL SCHMITT ÜZERİNDEN EGEMENLİK VE OLAĞANÜSTÜ HAL KAVRAMLARINI TARTIŞMAK

DISCUSING THE CONCEPTS OF SOVEREIGNTY AND STATE OF EMERGENCY  
THROUGH CARL SCHMITT

**Doktorant Gülçin SAĞIR KESKİN**

Ankara Üniversitesi Sosyal Bilimler Enstitüsü, İletişim Fakültesi, Gazetecilik Ana Bilim Dalı,  
Ankara, Türkiye

Orcid Numarası: 0000-0001-6933-4293

### ÖZET

Almanya'nın önemli hukukçu ve felsefecilerinden birisi olan Carl Schmitt, egemenlik ve olağanüstü hal kavramlarına dair akademik literatür içerisinde çeşitli tartışmaların başlatılmasına neden olmuştur. Yaşamış olduğu dönemde Nasyonal Sosyalist Alman İşçi Partisi'nin bir üyesi olan Schmitt, Almanya'nın hukuk düzeninin hangi koşullar etrafında inşa edileceğine dair de bir yol haritası oluşturmuştur. Schmitt'e göre olağanüstü hal, egemenliğin hukuki açıdan tanımlanabilmesinde son derecede önemlidir. Olağanüstü hale karar veren ve uygulayanların kimlerden oluştuğu, hangi durumlar sırasında olağanüstü halin ilan edildiği, iktidarın dinamiği açısından da değerlendirilmelidir. Bu çalışma içerisinde de Carl Schmitt'in *Siyasi İlahiyat Egemenlik Kuramı Üzerine Dört Bölüm* isimli eseri dikkate alınarak egemenlik kuramını hangi çerçeve içerisinde tanımlandığı tartışılacaktır. Egemenin kimlerden meydana geldiği ve hangi anayasal prosedürler temelinde tanımlandığı da analiz edilecektir. Ardından egemenlikle olağanüstü hal kavramı arasında inşa edilmiş olan kavramsal bağlantıya dikkat çekilecektir. Olağanüstü hal kavramından bahsedebilmek için hangi prensiplerden yola çıkıldığı ve verilen yetkilerin sınırlarının neler olduğu ifade edilecektir. Kurulu düzen ile olağanüstü hal arasında gerçekleşen mücadele biçimleri aktarılarak hukuk devleti ve anayasa nosyonları üzerinden gerçekleşebilecek hak ihlallerinin neler olduğu da çalışmada belirtilecektir.

**Anahtar Kelimeler:** Carl Schmitt, Egemenlik, Olağanüstü Hal.





## ABSTRACT

Carl Schmitt, one of Germany's important lawyers and philosophers, has initiated various discussions within the academic literature on the concepts of sovereignty and state of emergency. Schmitt, who was a member of the National Socialist German Workers Party during his time, created a road map on the conditions around which Germany's legal order would be built. According to Schmitt, the state of emergency is extremely important in legally defining sovereignty. Who decides and implements the state of emergency, and during which situations the state of emergency is declared, should also be evaluated in terms of the dynamics of power. In this study, it will be discussed within what framework the theory of sovereignty is defined, taking into account Carl Schmitt's work titled Four Chapters on the Theory of Sovereignty in Political Theology. Who constitutes the sovereign and on what constitutional procedures is it defined will also be analysed. Then, attention will be drawn to the conceptual connection between sovereignty and the concept of state of emergency. In order to talk about the concept of state of emergency, it will be stated what principles are used and what the limits of the powers given are. The forms of struggle between the established order and the state of emergency will be conveyed and the violations of rights that may occur through the notions of the rule of law and the constitution will also be stated in the study.

**Key Words:** Carl Schmitt, Sovereignty, State of Emergency.



**COMPUTATIONAL STUDY OF NEW BENZOSULFONAMIDES AS TRPV4  
ANTAGONISTS USING 3D-QSAR, MOLECULAR DOCKING , MOLECULAR  
DYNAMICS AND ADMET PREDICTION**

ETUDE COMPUTATIONNELLE DE NOUVEAUX BENZOSULFAMIDES EN TANT  
QU'ANTAGONISTES DU TRPV4 A L'AIDE DE 3D-QSAR, DYNAMIQUE  
MOLECULAIRE ,DOCKING MOLECULAIRE ET ADMET

**TOUGHZAOUI Abdelilah<sup>1</sup>. CHEDADI Oussama<sup>2</sup>. EL AISSOUQ Abdellah<sup>2\*</sup>.  
EL OUARDI Youssef<sup>3</sup>. BOUACHRINE Mohammed<sup>4</sup>. OUAMMOU Abdelkrim<sup>1</sup>  
.MORADI kamal<sup>1</sup>**

1 LIMOME Laboratory, Faculty of Sciences Dhar El Mahraz, Sidi Mohamed Ben Abdellah  
University, Fez, Morocco

2 Laboratory of Processes, Materials and Environment (LPME), Faculty of Science and  
Technology, Sidi Mohamed Ben Abdellah  
University, Fez, Morocco

3 Laboratory of Separation Technology, Lappeenranta University of Technology,  
Lappeenranta, Finland

4 MCNS Laboratory, Faculty of Sciences, Moulay Ismail University, Meknes, Morocco

**ABSTRACT**

En utilisant des techniques d'analyse computationnelle telles que la modélisation 3D-QSAR, le docking moléculaire et l'évaluation des propriétés pharmacocinétiques (ADMET), nous avons identifié de nouveaux ligands ayant une forte capacité inhibitrice sur divers dérivés aryl benzensulfonamides. Pour construire le modèle 3D-QSAR le plus optimal, nous avons utilisé l'analyse des moindres carrés partiels (PLS) et l'analyse comparative de l'indice de similarité moléculaire (CoMSIA), qui ont montré une excellente capacité de corrélation et de prédiction ( $R^2 = 0,953$ ,  $Q^2 = 0,747$ , et  $SEE = 0,072$ ). Notre étude a révélé que les champs électrostatiques, hydrophobes, accepteurs et donneurs de liaisons hydrogène jouent un rôle important dans les variations de l'activité biologique observée. Sur la base de ces résultats du Docking moléculaire et la dynamique moléculaire, ces résultats seront utiles pour l'optimisation et la découverte de nouveaux antagonistes du TRPV4.

**Keywords:** TRPV4antagonist, 3D-QSAR, Molecular docking, ADMET prediction, benzensulfonamide derivatives. Dynamic molecular



## POSTBİYOTİK VE SİMBİYOTİK ÖZELLİKLİ GIDALAR FOODS WITH POSTBIOTIC AND SYMBIOTIC PROPERTIES

**Dilber ÇAĞLAR**

Arge Mühendisi, Dimes Gıda San. Ve Tic. A.Ş.  
ORCID NO: 0000-0001-9712-5069

### ÖZET

Tüketicilerin fonksiyonel gıda ürünlerine talepleri günden güne artmaktadır. Gıda takviyesi veya doğrudan gıda şeklinde probiyotiklerin tüketilmesi bilinen fonksiyonel tüketim alışkanlıkları arasında yer almaktadır. Probiyotiklerin raf ömrü bu pazarın büyümesine engelleyici bir faktör olması nedeniyle postbiyotikle ilgili çalışmalar artış göstermektedir. Postbiyotikler canlı mikroorganizmalar tarafından üretilen metabolitlerdir. Postbiyotiklerin hem insan hem hayvanlar üzerine faydalı etkilerin olduğunu gösteren birçok çalışma yer almaktadır. Örneğin çocuklarda ve yetişkinlerde antioksidan ve antimikrobiyal etkisi, barsak epiteli üzerinde sağlığı olumlu yönde etkileyen potansiyel etkilerden söz edilmektedir. Simbiyotik gıdalar bir diğer fonksiyonel gıdaya örnektir. Hem probiyotik hem prebiyotikleri bir arada bulunduran maddelere simbiyotik denmektedir. Bal, anne sütü ve fermente gıdalar simbiyotik özellikli gıdalara örnek olarak verilebilir. Simbiyotik özellikli fermente gıdalar dış koşullara daha dayanıklı olması sonucu raf ömrünün uzun olması nedeniyle de beslenme için önemlidir. Simbiyotik özellikli gıdaların insan sağlığı üzerine olumlu etkilerini inceleyen içeren birçok çalışma mevcuttur. Simbiyotik gıdaların olumlu etkilerine antimikrobiyal, bağışıklık dengeleyici, antikanser, LDL-kolesterolü ve hipertansiyonu düşürücü etkiler örnek olarak verilebilir. Sonuç olarak postbiyotik ve simbiyotik özelliklere sahip gıdaların besin değeri yüksektir ve sağlığa olumlu etkileri vardır. Bunlara benzer fonksiyonel gıdaların araştırılması, çalışmaların detaylandırılması gıda sektöründe önemli bir yere sahiptir. Bu çalışmada fonksiyonel gıdalardan biri olan postbiyotik ve simbiyotiklerin sağlık üzerine etkileri ve gıdada kullanım alanları hakkında literatür çalışmaları incelenmiştir.

Çalışmaya verdiği değerli desteklerinden dolayı Dimes Gıda San. Ve Tic. A.Ş.'ye teşekkürlerimi sunarım.

**Anahtar Kelimeler:** Postbiyotik, Simbiyotik, Gıda, İnsan Sağlığı, Probiyotik



## ABSTRACT

Consumers' demand for functional food products is increasing day by day. Consuming probiotics as a food supplement or directly in the form of food is among the beneficial types of functional consumption. Since the shelf life of probiotics is a obstructor factor to the growth of market. Studies on postbiotics have been increasing recent years. Postbiotics are metabolites produced by living microorganisms. There are many studies showing that postbiotics have beneficial effects on both humans and animals. For ,instance, potential health-promoting effects such as antioxidant and antimicrobial effects on intestinal epithelium and antimicrobial effects in children and adults are mentioned. Symbiotic foods are another example of functional food. Substances that combine both probiotics and prebiotics are called symbiotic. Honey, breast milk and fermented foods are examples of symbiotic products. Symbiotic fermented foods are important for nutrition as they are more durable outside and have a longer shelf life. There are many studies showing that symbiotic foods contribute positively to human health. Antimicrobial, immune balancer, anticancer, LDL-cholesterol and hypertension lowering effects can be given as examples of the positive effects of symbiotic foods. As a result, foods with postbiotic and symbiotic properties have high nutritional value and have a positive impact on health. The existence of functional foods similar to these has an important place in the nutrition sector. In this study, literature studies on the effects of postbiotics and symbiotics, one of the functional foods, on health and their uses in food were reviewed.

I wish to acknowledge to Dimes Food Ind. and Inc. for their valuable supports to the study.

**Key Words:** Postbiotic, Symbiotic, Food, Human Health, Probiotic



## FRANSANIN MÜSTƏMLƏKƏ SİYASƏTİNƏ QARŞI ƏLCƏZAİR ƏDƏBİYYATI

### ALGERIAN LITERATURE AGAINST FRENCH COLONIAL POLICY

**Filologiya üzrə fəlsəfə doktoru, dosent Ələkbərova Xumar Elham**

Azərbaycan Milli Elmlər Akademiyası, Z.M.Bünyadov adına Şərqişünaslıq İnstitutu

**PhD in philological sciences, assistant professor Alakbarova Khumar Elham**

Institute of Oriental Studies of Azerbaijan National Academy of Sciences

ORCID N: 0009-0004-5348-64-78

### XÜLASƏ

XIX əsrdə Fransanın Əlcəzairi işğalı ilə bu ərəb ölkəsində başlayan müstəmləkə siyasəti həm maddi, həm mənəvi cəbhələrdə davam etdirilmişdir. Belə ki, Fransanın Əlcəzairin milli sərvətlərinə, ucuz işçi qüvvəsinə hesablanmış işğalçılıq planları bununla kifayətlənmişdir: həmin dönmədə bura fransızların kütləvi köçürülməsi, Fransa hökumətinə etiraz edənlərin təqib və sürgünlərə məruz qalması, xalqın dilindən və ədəbiyyatından məhrum edilməsi, tarixinin və adət-ənənələrinin məhvəliyə hədəflənmiş siyasət yürüdülməsi kimi düşünülmüş, planlı addımlar atılır.

Nəhayət ötən əsrin 50-ci illərindən başlayan Əlcəzair xalqının istiqlaliyyət uğrunda mübarizəsi çox qurbanlar bahasına yalnız 1962-ci ilin sentyabrında Əlcəzair Xalq Demokratik Respublikası elan edilməsi ilə nəticələnir. Əlcəzairi tarixi ərazisi olaraq soyğunçu təfəkkürünə yazmış Fransa Əlcəzairin müstəqilliyini tanısa da, bununla barışa bilmir. “Ədalət bayrağı”, “haqq müdafiəçisi”, “sivil və human” kimi adlarla insanlığa sığmayan vəhşiliklərini örtməyə çalışan bu qərb dövləti uzun illər pəncəsini Əlcəzairin üstündən çəkmək istəmir, ölkədə aparılan islahatlara, gedən proseslərə müdaxilələr edir, Fransada məskunlaşmış əlcəzairli ərəblərə qarşı diskriminasiya, təqib siyasəti yürüdür, bir sözlə məkrli talançı planlarından vaz keçmək istəmir.

Əlcəzair tarixinin ağır və daha mürəkkəb səhifələrini özündə ehtiva bu dönmə ədəbiyyatda ayrıca mərhələnin formalaşmasına səbəb olur. Ümumiyyətlə Fransa müstəmləkəsindən qurtulana qədər ərəb dilində demək olar ki, mövcud olmayan Əlcəzair ədəbiyyatı 60-cı illərdən etibarən yeni nəfəs qazanır. Artıq ərəb dilində yaradılan Əlcəzair ədəbiyyatı fərqli ideya-məzmun, forma xüsusiyyətləri ilə xarakterizə olunur. Bu dövrdə yaranan ədəbiyyatda “ərəbləşmə” meyilləri “Əlcəzair təəssübkeşliyi” ilə, inqilabi əhval-ruhiyyə realizm notları ilə müşayiət olunur. Fransanın işğalçılıq siyasətinə qarşı çıxış edən, milli-azadlıq hərəkatını dəstəkləyən bu ədəbiyyatın əsas siyasi şüar və tələbləri Məəmmər Mulud, Muhəmməd Dib, Anri Alleq, Mulud Fəraun, Vattar Ət-Tahir, Assiya Cəbar və b. əlcəzairli yazarların əsərlərində əsas ideya xətti təşkil edir.

Əlcəzair ədəbiyyatının korifeyləri sayılan bu müəlliflər yalnız ədəbi yaradıcılıqları ilə deyil, ictimai, siyasi fəaliyyətləri ilə də Fransa müstəmləkəçiliyinə qarşı xalq hərəkatında fəal iştirak edirlər. Onlardan biri - Fransanın müstəmləkəsi Əlcəzairdə dünyaya gəlmiş, Fransa ordusunun zabiti kimi İkinci Dünya savaşında iştirak etmiş Məəmmər Mulud (1917-1989) ölkəsinin azadlığı uğrunda sərt çıxışlarına, aktiv ictimai fəaliyyətinə görə 1857-ci ildə Mərakeşə mühacirət etməyə



məcbur qalmış və yalnız 1962-ci ildə Əlcəzairin müstəqillik əldə etməsindən sonra Vətənə qayıda bilməmişdir. Onun Fransa işğalçılığına son qoyulmasına çağıran, Əlcəzair xalqının azadlıq mübarizəsindən bəhs edən şah əsəri “Tiryək və dəyənək” (1965) romanı Əlcəzair ədəbiyyatında qəhrəmanlıq epopeyasını yaranmasının əsasını qoymuşdur. Əksər ərəb ölkələrində yayılan, bir çox dillərə tərcümə olunmuş roman hətta 1969-cu ildə ekranlaşdırılmış və daha çox kütləviləşdirilmişdir. Vətəninin azadlığı uğrunda canından keçənlərin mübarizə yolu, təqib qurbanlarının naməlum taleyi, fransızların insanlığa sığmayan işgəncə metodlarını əks etdirən səhnələr əsər boyu oxucunu rıqqətə gətirir. Bu işgəncələri canlı yaşamış siyasi xadim, jurnalist, Əlcəzair mənşəli Anri Alleqin (1921-2013) “İstintaq” əsəri də (1957) oxşar tükürpədicə epizodlarla xarakterizə olunur, 1977-ci ildə ekranlaşdırılmışdır. Bu əsərlər silsiləsinə Vattar Ət-Tahirin (1936-2010) real tarixi hadisələrə əsaslanaraq yazılmış “Tuz” (1974), “Zəlzələ” (1974) və s. romanları da daxil etmək olar.

Bu qeyd edilənlər, özünü demokratik, sivil, himanist ölkə adlandıran Fransanın tarixində silinməz qara ləkənin real tarixi sübutlarını ehtiva edən yeni dövr Əlcəzair ədəbiyyatı haqqında yalnız qısa xülasə xarakteri daşıyır. Əlbəttə ki, bu mövzu daha çox sayda ədibin yaradıcılığını əhatə etməklə, daha geniş müstəvidə müzakirə olunmaq üçün aktualıq kəsb edir.

**Açar sözlər:** ərəb ədəbiyyatı, Əlcəzair ədəbiyyatı, müstəmləkə siyasəti, Fransa, Əlcəzair, milli-azadlıq hərəkatı

## ABSTRACT

The colonial policy initiated in this Arab nation during the 19th century French occupation of Algeria extended its reach across both tangible and moral dimensions. Beyond France's invasion strategies targeting Algeria's resources and labor force, a substantial resettlement of French citizens occurred. Simultaneously, dissenting voices faced persecution and exile, linguistic and literary suppression, alongside a deliberate effort to erode the region's history and traditions—a calculated campaign that unfolded methodically.

Ultimately, the Algerian people's quest for independence, initiated in the 1950s, culminated in the establishment of the People's Democratic Republic of Algeria in September 1962, achieved at great sacrifice. Despite formally acknowledging Algeria's independence, France remains reluctant to fully embrace it. This Western nation, under the guise of being a "flag bearer of justice" and a "defender of rights," persists in interfering with Algerian reforms, discriminates against and persecutes Algerian Arabs residing in France. In essence, France continues to pursue its cunning exploitative agenda.

This turbulent period, marked by intricate facets of Algerian history, has given rise to a distinctive literary era. Algerian literature, virtually absent in Arabic until liberation from the French colony, has experienced a renaissance since the 1960s. The literature, now predominantly in Arabic, reflects unique thematic and stylistic characteristics. "Arabization" trends coexist with "Algerian bigotry," and revolutionary fervor intertwines with realist undertones in works created during this



epoch. The literary contributions of figures like Mouloud Mammeri, Mohammad Dib, Henri Alleg, Mouloud Feraoun, Tahar Ouetar, Assia Djébar, and others echo the primary tenets of this literary movement, opposing French occupation policies and endorsing the national liberation movement.

Renowned as luminaries in Algerian literature, these authors actively engaged in the people's resistance against French colonialism, not only through their literary endeavors but also via impactful social and political activism. Among them, Mouloud Mammeri (1917-1989), born in the French colony of Algeria and a French army officer during the Second World War, faced exile to Morocco in 1957 due to his fervent advocacy for his country's freedom and robust social involvement. Only in 1962 could he return to Algeria post its independence. His seminal novel, "Opium and Baton" (1965), a powerful call to end French occupation and an exploration of the Algerian people's struggle for freedom, laid the groundwork for an heroic epic in Algerian literature. Widely distributed in Arab countries and translated into numerous languages, the novel was adapted into a film in 1969, gaining further popularity. The narrative unfolds the poignant struggle of those who sacrificed their lives for homeland freedom, the unknown fates of persecution victims, and chilling scenes depicting French inhumane torture methods, evoking deep empathy in the reader.

Henri Alleg (1921-2013), a political figure, journalist, and Algerian native who endured similar tortures, authored the work "Investigation" (1957), marked by grim episodes and later adapted into a film in 1977. Works like "Al Laz" (1974), "Earthquake" (1974), and others by Tahar Ouetar (1936-2010), grounded in real historical events, contribute to this compelling series. These glimpses offer but a concise overview of the new era in Algerian literature, a repository of historical evidence exposing an indelible black mark in France's self-proclaimed democratic, civilized, and humanist history. This topic merits broader discussion, encompassing the creative contributions of a more extensive array of writers.

**Keywords:** Arabic literature, Algerian literature, colonial politics, France, Algeria, national liberation movement



## INVESTIGATION OF OPTICAL AND PHOTSENSOR PROPERTIES OF La-DOPED ZnNiO THIN FILMS

**Assist. Prof. Dr. Sezen TEKİN**

Çankırı Karatekin University

ORCID: 0000-0002-6599-9631

**Lect. Tuğba ÇORLU**

Süleyman Demirel University

ORCID: 0000-0001-5828-207X

**Assoc. Prof. Dr. Irmak KARADUMAN ER**

Çankırı Karatekin University

ORCID: 0000-0003-3786-3865

**Prof. Dr. Selim ACAR**

Gazi University

ORCID: 0000-0003-4014-7800

### ABSTRACT

Stability in drugs is the ability of the drug to remain intact or maintain its chemical and physical properties throughout its shelf life in its packaging and under appropriate storage conditions. A drug must have five stability properties throughout its shelf life: Chemical, Physical, Microbiological, Therapeutic and Toxicological Stability. The stability of the drug substance determines the formulation, use of preservatives and type of packaging. Thus, pharmaceutical packaging consisting of materials that are not exposed to UV light and the control of these packaging are of great importance.

In this study, ZnNiO and La-doped ZnNiO thin films were produced and absorbance, transmittance, absorbance coefficient, optical dielectric properties etc. has been examined in detail depending on different Zn and Ni ratios and La contribution. In addition, the photo sensor properties were examined and the commercial usability of the thin films used was investigated.

**Keywords:** Stability, Drug, SILAR , Optical properties, photosensor

**Corresponding author:** [irmakkaradumaner@karatekin.edu.tr](mailto:irmakkaradumaner@karatekin.edu.tr)





## INTRODUCTION

Packaging materials significantly affect the functionality of the product. When product packaging is used to convey information, it must be designed to carry written content or graphics. High energy lights are effective in photolysis reactions, which are described as the breakdown of a chemical compound by photons. Considering the inverse relationship between wavelength and energy, rays originating from the visible (400-750 nm) and ultraviolet (UV) (100-400 nm) regions of the electromagnetic spectrum cause photolysis. (Dilkes-Hoffman et al., 2018).

This shows that drugs may be subject to photolysis degradation both in sunlight and in indoor environments such as rooms (Acartürk et al., 2006). Different methods must be applied to drugs containing active ingredients with photolysis properties, both during manufacturing and storage. Photolysis can be prevented by using appropriate packaging (coloured glass, (amber), blister packaging and aluminum foil) and by using substances that absorb UV light (PABA, phenyl salicylate)(Ahmad et al., 2016). Recycling glass to produce new bottles and jars requires significantly less energy and is therefore preferable to save resources.

A validated and stable analysis method is needed to identify drug and photoproducts (Ahmad et al., 2016). Photostability testing is required by the pharmaceutical industry to evaluate handling, packaging and labeling. Photosensors are therefore widely used. Photodetectors are devices that detect electromagnetic waves of certain wavelengths. Generally, semiconductor materials with appropriate band gap are used to detect the incoming photon. Such photodetectors are composed of p-n junction structures of semiconductors with suitable band gap (Singh et al., 2011). As it is known, a p-n junction structure occurs when the equilibrium state is reached as a result of diffusion currents due to the carrier concentration difference of both semiconductors. In general, every p-n junction structure is sensitive to photons. When a photon reaching the p-n junction region is absorbed in the junction region, it creates electron-hole pairs, and these electron-hole pairs separate from each other due to the electric field in the junction region, creating a photocurrent. It is necessary to use semiconductor materials with a bandgap suitable for the photon to be detected. For a semiconductor material to be photoconductive, it must contain free electrons and holes. The rays that are absorbed through the semiconductor re-create the distribution of these free electrons and increase the conductivity of the material. A photodiode is obtained by combining thin films and contacts against each other. As the light falls on the photodiode, the charges cross the forbidden energy gap and contribute to conductivity.

In this study, ZnNiO and La-doped ZnNiO thin films were produced and absorbance, absorbance coefficient, optical dielectric properties etc. has been examined in detail depending on different Zn and Ni ratios and La contribution. In addition, the photo sensor properties were examined and the commercial usability of the thin films used was investigated.

## EXPERIMENTAL METHOD

The samples were produced with SILAR method. The experimental setup consists of 4 steps: solution, then hot water, drying in air and keeping in deionized water. First, the solution required to grow thin films is prepared. 0.1 M zinc chloride ( $ZnCl_2$ ) solution was prepared by



dissolving it in 100ml ultradeionized water. Then ~5ml ammonium hydroxide ((NH<sub>4</sub>)OH) was added to make the solution alkaline (until the pH value was approximately 12).

Then, nickel chloride solution (ZnCl<sub>2</sub>) was prepared in the same proportions. In our study, solutions were prepared by changing the Ni and Zn ratios in the given ratios. Additionally, by adding doping material at a constant La concentration, the effects of Ni and Zn changes on the structural and electrical properties of thin films were examined.

The cleaned and prepared gold interdigital contact glass substrates were first immersed in the prepared solution and then in hot water. The substrates, which were kept in air after hot water, were then immersed in pure water at room temperature. Thus, a cycle was completed. This process was done in forty cycles for each different contribution rate. Thus, the enlargement process was performed on all thin films. The base material was left in the [Zn(NH<sub>3</sub>)<sub>4</sub>]<sup>2+</sup> ve [Ni(NH<sub>3</sub>)<sub>4</sub>]<sup>2+</sup> solution for 15 seconds, and an aqueous thin film layer containing the [Zn(NH<sub>3</sub>)<sub>4</sub>]<sup>2+</sup> complex was coated on the surface of the base material. The glass substrate was deported from the solution of thin films and gripped in pure water at 90 °C for 7 seconds. The aim here is to ensure the conversion of Zn(OH)<sub>2</sub>→ZnO. Substrates removed from hot water were kept in air for 60 seconds. Then, it was kept in pure water at room temperature for 30 seconds. Thin films were grown at different Ni and Zn ratios by adding the last lanthanum additive. Thus, the effect of the additive material on the optical and photoresponse properties was examined.

## RESULTS AND DISCUSSIONS

Figure 1 shows the absorbance spectra of the produced Samples. It was observed that the absorption of thin films in the visible region was lower than 1%. When the transmittance values shown in Figure 2 are examined, it is seen that the transmittance of thin films varies in the visible region and increases up to 90% as the applied wavelength approaches the infrared wavelength (Tekin ve Karaduman, 2022). The transmittance of the Samples were measured 90%, 31 %, 30 %, 78 % and 76 % for NiO, NiO/ZnO, 16Ni.16Zn.8La, 28Zn.4Ni.8La and 28Ni.4Zn.8La, respectively. When comparing Ni and Zn in the same ratios, La contribution and differences in Ni and Zn ratios increased the transmittance value. The only point that should be noted is that the pure NiO sample showed the highest transmittance value. When examined optically, the same contribution rates caused a decrease in Ni and Zn transmittance values.

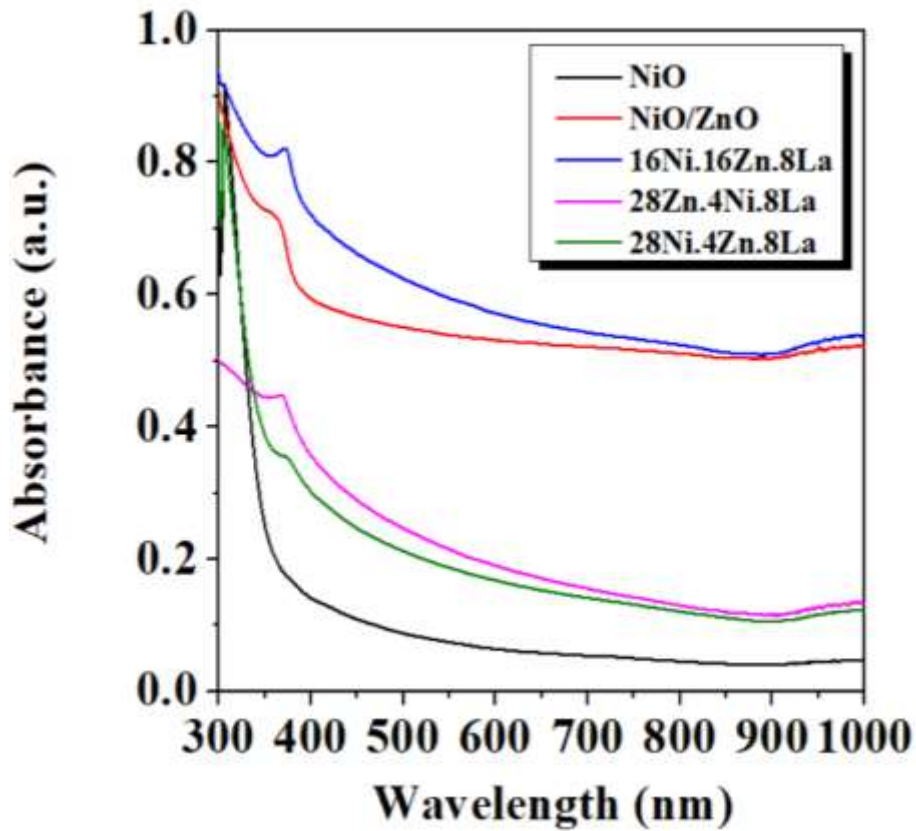
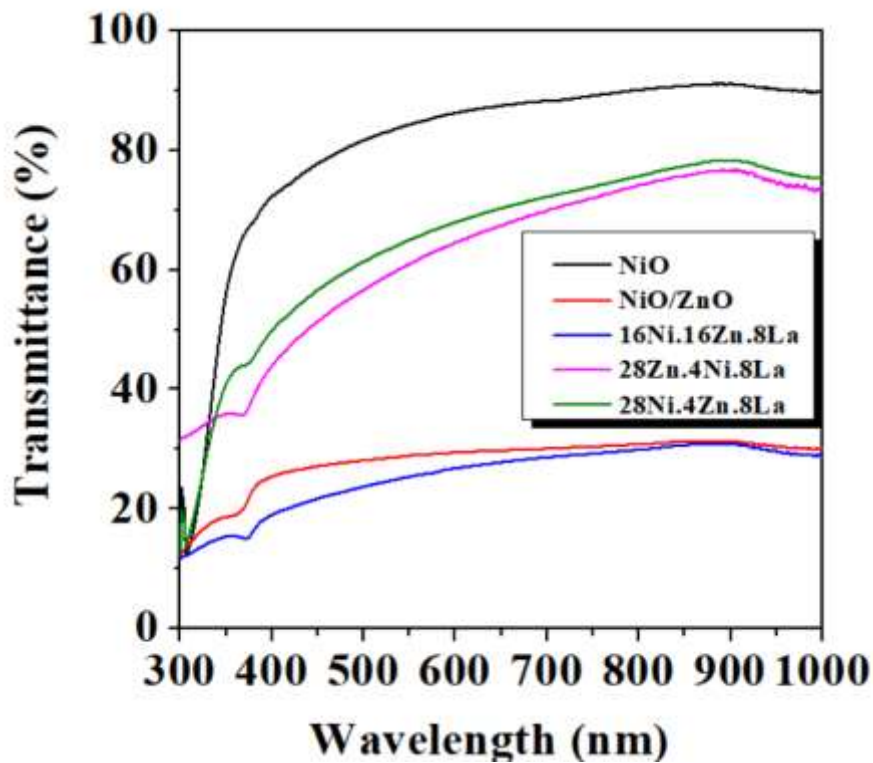

Figure 1. The absorbance spectra of the produced samples

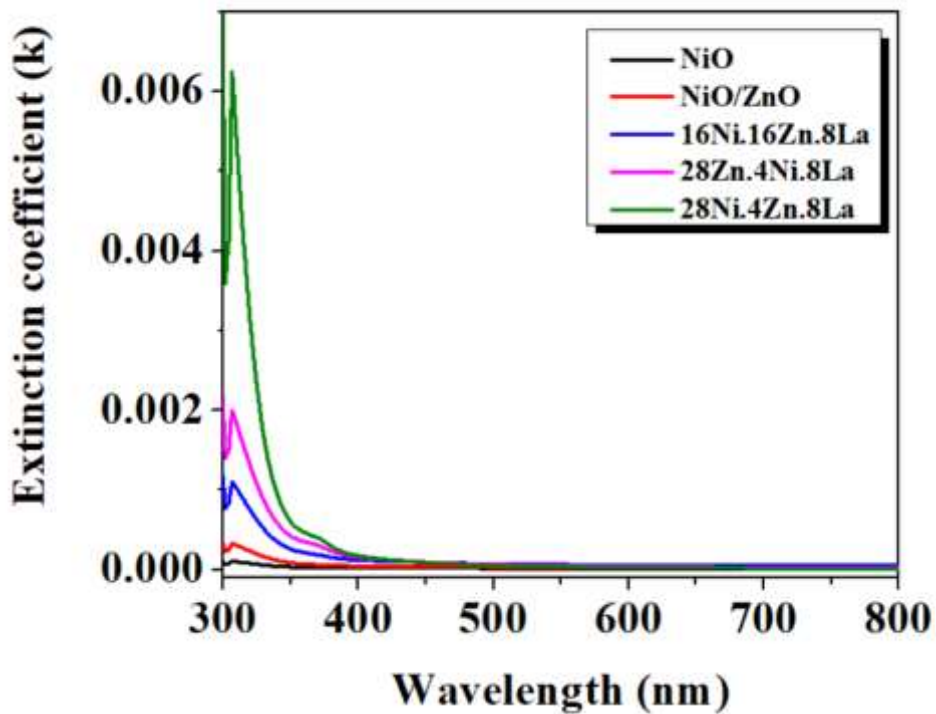

**Figure 2.** The transmittance spectra of the produced Samples

The extinction coefficient ( $k$ ) is calculated as the below equation (Shano et. al., 2021);

$$k = \frac{\alpha\lambda}{4\pi} \tag{1}$$

Where  $\alpha$  is the absorption coefficient,  $\lambda$  is the wavelength and  $\pi$  is the constant. Figure 3 gives the  $k$  values of produced samples versus wavelength. It can be seen that there is a separation in the form of branching for the values of  $k$  in the low wavelength.



**Figure 3.** The extinction coefficient of the produces samples versus wavelength

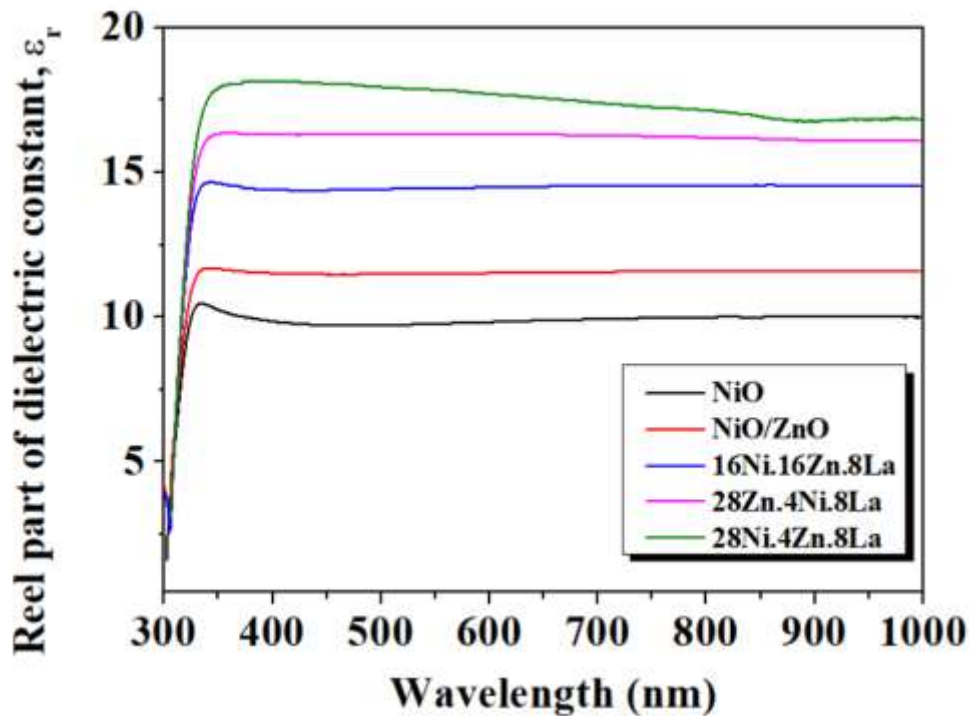

**Figure 4.** Reel part of dielectric constant of the produced Samples

The I-V characteristics of the NiO (a), NiO/ZnO (b) and 16Ni.16Zn.8La (c) have been measured in dark and illumination conditions at a bias voltage between -5 V and 5 V prepared using different La concentrations which are presented in Figure 5. Linear I-V graphs show that when electrical contact is made, current is transmitted in both directions and therefore it has ohmic properties. Also, the current-voltage characteristics of 28Ni.4Zn.8La (a) and 28Zn.4Ni.8La (b) in dark and illumination conditions, as shown in Figure 6. According to I-V measurements taken in the dark, the currents of pure ZnO films are lower.

The working principle can be explained that; carrier concentrations in the conduction and valence band of the semiconductor material change with the photon incident on it. This is because the incoming photon transfers its energy to the electron in the valence band and carries it to the conduction band (Dugan et. al. 2019). As a result, the electron moving from the valence band to the conduction band leaves a hole behind. This occurs when the energy of the incident photon is equal to or greater than the band gap of the semiconductor material. This phenomenon is the fundamental absorption phenomenon. If the energy of the incoming photon is lower than the forbidden band gap of the semiconductor material, the incoming photon passes without being absorbed (Kurnaz Yetim et. al., 2020).

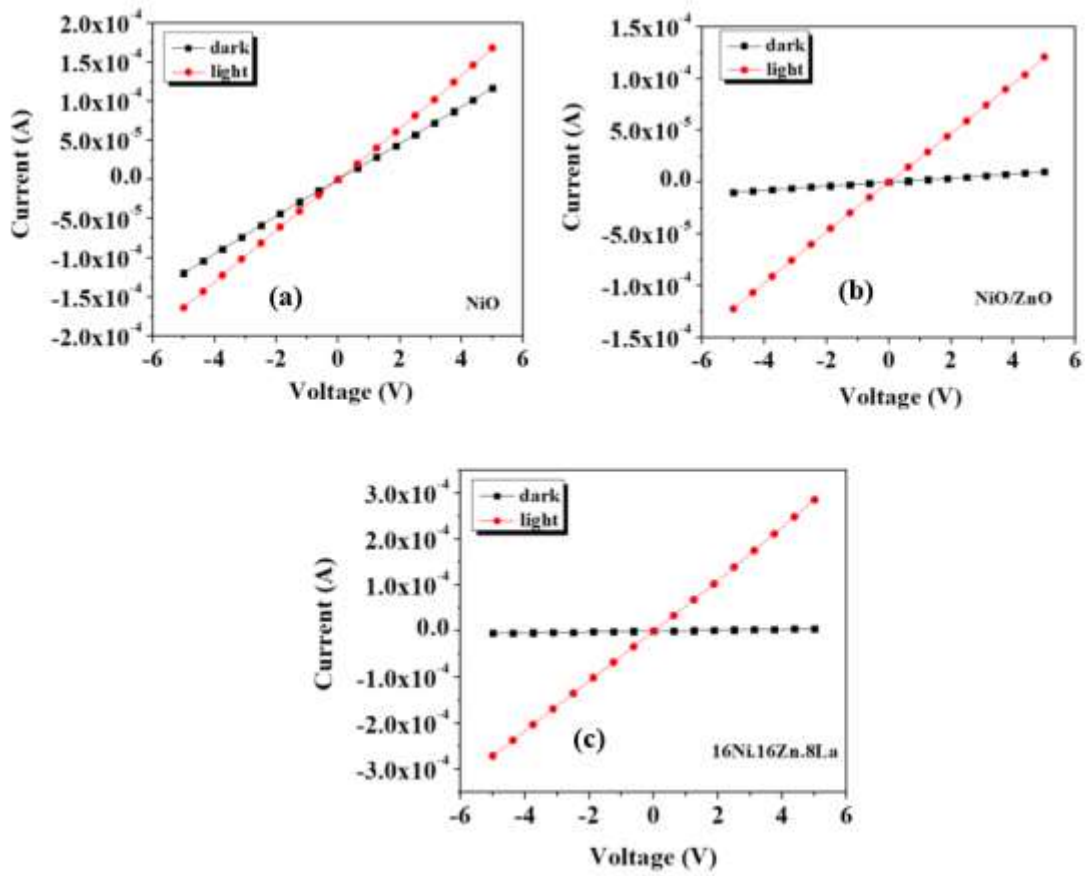

**Figure 5.** Current-Voltage Characteristics of NiO (a), NiO/ZnO (b) and 16Ni.16Zn.8La (c) in dark and illumination conditions

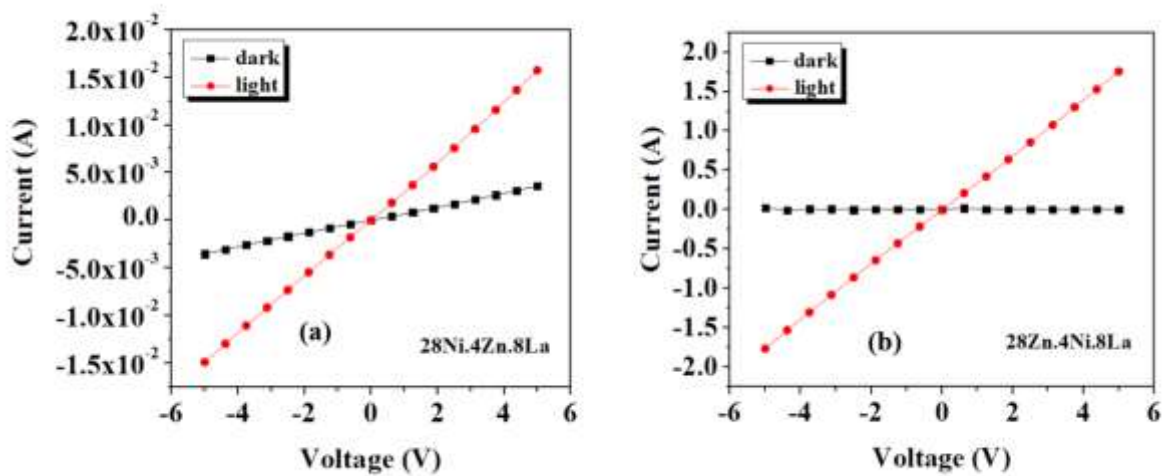

**Figure 6.** Current-Voltage Characteristics of 28Ni.4Zn.8La (a) and 28Zn.4Ni.8La (b)



in dark and illumination conditions

Figure 7 shows the resistance of the produced Samples in dark and illumination conditions. Increasing electrical resistivity causes an increase in electrical resistance, which means a decrease in current under constant voltage. Low current in a dark environment is very important for photo detectors. Because the signal-to-noise ratios of low-current or high-resistance photodetectors are higher in dark environments. Doping helps to change the physical, chemical, electrical and magnetic behaviors of materials or to keep these characteristic behaviors within desired limits (Kösemen et. al., 2016). When a conductive substance is adsorbed onto an insulating material, the insulating material can be given conductive properties. As can be understood, it is possible to change the physical properties of materials by doping. For this reason, it is known that doping methods are used in optoelectronic applications to obtain the desired optical, electrical and electronic properties and to reach the desired values such as capacitance, photoresponse, photocurrent, forbidden energy ranges and barrier height (Koç et. al., 2019). According to these results, it is clear that changes in the lanthanum element and ZnO and NiO ratios play an important role in increasing photocurrent. When the resistance values are examined, it is seen that the 28Zn.4Ni.8La sample has the lowest resistance.

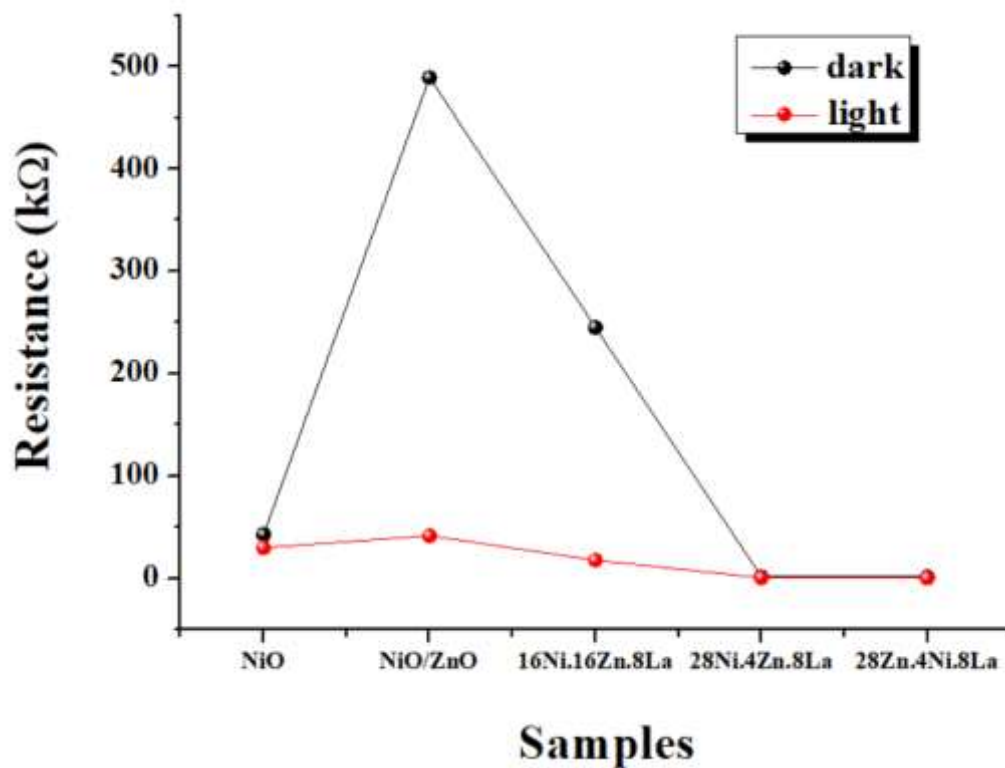

Figure 7. Resistance of the produced Samples in dark and illumination conditions



## CONCLUSION

In this study, NiO and ZnO samples were grown with the SILAR method by changing Ni and Zn at different rates and adding La, and their optical and photosensor properties were examined. When the studies were carefully examined, although the NiO sample had the best transmittance feature, the sample that gave the best photosensor properties was the 28Zn.8Ni.4La sample.

## REFERENCES

- Acartürk F. (2006). Reaksiyon Kinetiği ve Stabilite, Modern Farmasötik Teknoloji, TEB Eczacılık Akademisi, Ankara, 141-182.
- Ahmad I., Ahmed S., Anwar Z., Sheraz M. A., Sikorski M., (2016). Photostability and Photostabilization of Drugs and Drug Products, Journal of Photoenergy, 8135608. <http://dx.doi.org/10.1155/2016/8135608>
- Dilkes-Hoffman, L.S., Lane, J.L., Grant, T., Pratt, S., Lant, P.A., Laycock, B., 2018. Environmental impact of biodegradable food packaging when considering food waste. J. Clean. Prod. 180, 325–334. <https://doi.org/10.1016/j.jclepro.2018.01.169>.
- Singh A., Kumar Sharma P., Malviya R. (2011). Eco Friendly Pharmaceutical Packaging Material , World Applied Sciences Journal 14 (11): 1703-1716.
- Tekin, S., Karaduman Er, I. (2022). The structural, morphological, optical and gas-sensing properties of Mn<sub>3</sub>O<sub>4</sub> thin films grown by successive ionic layer adsorption and reaction technique. *J Mater Sci: Mater Electron* 33, 14519–14534 <https://doi.org/10.1007/s10854-022-08372-w>
- Shano A.M., Habeeb A.A., Khodair Z.T., Adnan S.K., (2021). Effects of thickness on the structural and optical properties of Mn<sub>3</sub>O<sub>4</sub> nanostructure thin films. J. Phys. Conf. Ser. 1818, 012049 <https://doi.org/10.1088/1742-6596/1818/1/012049>
- Dugan S., Koç, M. M, Coşkun B. (2019). Structural, electrical and optical characterization of Mn doped CdO photodiodes, J. Mol. Struct., vol. 1205, p. 127235, Oct..
- Kurnaz Yetim N., Aslan N., Koç M. M. (2020). Structural and catalytic properties of Fe<sub>3</sub>O<sub>4</sub> doped Bi<sub>2</sub>S<sub>3</sub> novel magnetic nanocomposites: p-Nitrophenol case, J. Environ. Chem. Eng., 8, 5, 104258.
- Koç M.M, Naim Aslan, Erkovan M., Aksakal B., Uzun O., Aslam Farooq W., Yakuphanoglu F. (2019). Electrical characterization of solar sensitive zinc oxide doped amorphous carbon photodiode, Optik (Stuttg)., 178, 316–326.
- Kösemen A., Kösemen Z.A, Canimkubey B., Erkovan M., Başarir F., San S.E., Osman Örnek, Tunç A.V. (2016). Fe doped TiO<sub>2</sub> thin film as electron selective layer for inverted solar cells, Sol. Energy, 132, 511–517.





## THE MEANING OF JEWELRY FOR WOMEN IN INDIAN AND MOROCCAN CULTURES

**Irina-Ana DROBOT**

Lecturer, PhD, Technical University of Civil Engineering Bucharest, Faculty of Engineering in Foreign Languages, Department of Foreign Languages and Communication, Bucharest, Romania

ORCID No: 0000-0002-2556-6233

### ABSTRACT

The purpose of this paper is to look at the ways in which women in both Indian and Moroccan cultures wear lots of jewelry items, and at the meaning of these practices. What is striking for members of other cultures is how young women in Indian and Moroccan Berber cultures especially wear lots of jewelry, on their heads and on their faces included. While Western culture members sometimes go, when wearing jewelry, by the principle that less is more, they still find the rich jewelry young women in Indian and Moroccan cultures wear very appealing. For Indian women, wearing lots of jewelry is considered a measure of their happiness, function of how many items they wear. Jewelry has symbolic value regarding several aspects in Indian culture. As an example, jewelry items with floral patterns are symbols of the connection between the woman and nature. Jewelry items are also related to the chakras in the body, and, by placing them on certain places over the body for decorative purposes, it is believed that there is going to be, for the wearer, a harmony of sensations. Wearing jewelry for Indian women has to do with religious practices and enhancing spirituality. This is one of the main differences between Indian and various Western cultures. In Western cultures, there is no such interconnection between wearer and jewelry items, from a spiritual and religious point of view, at least not to such a large extent as in Indian culture. In Western cultures, we may have some symbolic jewelry such as the wedding ring, but women do not wear jewels in such a manner as in Indian culture for religious reasons. For Western culture women, jewelry items are considered an elegant accessory, which is given most of all personal significance, if the respective jewel reminds them of a special person or moment in their lives. This could be since Western cultures are generally individualist, while Asian and Middle Eastern cultures are collectivist. Jewelry items become, for Indian women, part of their connection with the entire community's rituals and beliefs. For Morocco, craftsmanship of the jewelry is also



important, and here we can see two main traditions, those of the Berber and Tuareg. For Western culture members, Moroccan jewelry has a widespread appeal. We can see the way in which Moroccan jewelry can be used as a cultural product to popularize their culture, or to make use of its soft power. For Moroccan Berber women, jewelry items are their most valuable possessions. For Berber women, wearing jewelry items passed down from one generation to the other is a symbol of preserving their cultural identity.

**Keywords:** Symbol, Culture Awareness, Traditions, Spirituality, Happiness

## INTRODUCTION

Jewelry items have been present throughout all historical ages and throughout all cultures. However, some cultures have a stronger tradition related to jewelry craft than others, and practices related to wearing jewelry which go well beyond their aesthetic appeal and their use as a fashion statement in Western cultures. This is the case with Moroccan and Indian culture jewelry items. In Moroccan and Indian cultures, jewelry items are not used as individualist cultures symbols, but as collectivist cultures symbols. The individuals are not meant to use jewelry items to stand out as creative and unique from the crowd, but to keep in touch with their community's traditions. Yet, Western culture members, when getting into contact with Moroccan and Indian cultures, tend to use these jewelry items as means of standing out from the crowd, as we can see in fashion shows and trends which are inspired by jewelry in these cultures.

Whereas individualist societies place focus on the individual's creativity and personal achievements and, in this case, style, collectivist cultures place focus on the way individuals are part of the same community and share the same values, practices and traditions, sticking together for the benefit of the group (Hofstede, 2011).

Moroccan jewelry is famous around the world, having, as a distinctive feature, chunkiness and great attention to detail. We can distinguish two main traditions in Moroccan jewelry craft: Berber (Bernasek, 2008) and Touareg (Loughran, 2003). What stands out about their jewelry is the way it looks, and which has been called statement jewelry (Maayaz.com, 2016) due to its large size. Additionally, women belonging to these cultures wear jewelry on their heads, just as women in Indian cultures do. This type of head jewelry is not found in Western



cultures, unless we think about royalty, who wear crowns. However, this practice for Moroccan and Indian cultures is for people in everyday life, who do not need to have a high social status to wear such jewelry items. Additionally, we could also notice how Indian women actually wear jewelry items from head to toe, literally speaking. The same can be noticed about Berber and Touareg women, who wear large, chunky necklaces, bracelets, as well as ankle bracelets, in addition to their head jewelry items.

Both Berbers and Touaregs are from Africa. The Touaregs are an ethnic group within Berber culture. Berbers are divided into lots of ethnic groups who speak a variety of Berber languages. The Berbers are the indigenous population of the North African region of Maghreb. Berber communities are found in areas of Morocco, Algeria, Libya, Tunisia, Mauritania, the North of Mali and Niger, and to a small extent in Burkina Faso and in the Siwa Oasis in Egypt. The Touareg population lives in Sahara, from the South-West of Libya to to the South of Algeria, Niger, Mali, Burkina Faso, and small communities are also found in Northern Nigeria. The Touaregs' traditional way of life was that of nomadic pastoralists. The Berbers were also nomads, because of the harsh conditions in the Sahara desert. They actually chose most of them to live nomadic lives, instead of sedentary agrarian lives. We can include Berbers and Touaregs within Moroccan culture since for the Western culture members it can be easier to locate. Additionally, Moroccan culture has soft power (Nye, 2017) advantage for Western culture members, who are willing to visit this land of aesthetically pleasing cultural products, nicely crafter architecture, the famous blue city of Chefchaouen, and the architectural designs which are considered specific to this culture. Moroccan culture is popular among tourists and considered an exotic destination. The Berber jewelry especially is also popular, as it has served for inspiration for fashion designers in Western cultures for large, statement, ethnic jewels (Maayaz.com, 2016).

Indian culture also has a recognizable cultural heritage of jewelry craft. According to Sharma (2022), Indian jewelry has existed since the country has been attested by history. We notice, thus, a very strong bond between culture and jewelry items, in the case of India, as well as in the history of Moroccan culture, which explains why jewelry can be such a significant part of the members of this culture's life. The Mughal period marks the moment when the most beautiful and intricate jewelry items were created in India (Sharma, 2022).

We could speak of jewelry crafting and wearing as practices, rituals and traditions included in



the culture identity manifestations grid devised by Baciu (2013). When we refer to the specific types of chunky, statement jewelry specific to Moroccan Berber and Touareg cultures, and to the specific Indian culture jewelry items, we can think of them as symbols, which are also included in the culture identity manifestations grid. These jewelry items, as worn by the women belonging to these cultures, stand for something else than they are. The jewelry items acquire a certain meaning, such as, in the case of Berber women, what they own that is the most valuable and also preserving their cultural identity by passing down jewelry items from one generation to another. In the case of Indian women, if they wear lots of jewelry items, this is a way to tell that they are very happy. Some specific patterns, such as floral ones, symbolize the woman's connection to nature. Indian culture jewelry items can also be placed on certain chakras and symbolize the activation of the respective chakras and corresponding energy. Spirituality is an agreed upon symbol for jewelry items worn by Indian women.

We witness a very strong sense of connection between the woman wearing the jewelry items and the symbols and practices associated with them. Spirituality and various emotions related to the connection with previous generations, with the identity of their culture, in the case of Berber women, and connection with their own body and sensations which should be in harmony with their psychological well-being for Indian women show a particular relationship of the women in these cultures to their jewelry items. For them, jewelry items are not simple means of accessorizing and looking aesthetically pleasing. Jewelry items for them are even more than status symbols. They are symbols of spirituality and also part of these cultures' heritage preservation.

## **MATERIALS AND METHOD**

First of all, we can look at examples of Berber, Touareg and Indian culture women's photographs wearing lots of jewelry to understand the differences between these cultures and Western cultures, as rough landmarks of differentiation. As a common element, we can see that these photographs show outfits not worn in everyday life and not worn to differentiate themselves with their creative style. These outfits are traditional outfits, established by their community and culture to preserve their heritage and to connect with the values and practices of the community. By wearing such outfits and such jewellery, women belonging to these cultures can see themselves in the context of respecting and practising specific rituals and

traditions which bind them to their community's way of life. In this way, they can feel that they belong to their culture and community, and are accepted as members.

Wearing specific jewellery items means joining in their community's traditions and expressing themselves in conformity with the rules of their society.

We can see, in Fig.1, how lots of jewellery worn on the head and as necklaces are part of the traditional Berber costumes for women:



Fig. 1. Traditional Berber costumes and jewellery. Image source:

<https://www.alamy.com/stock-photo-women-wearing-traditional-costumes-and-berber-jewellery-tunisia-86139209.html>

We could relate the head wear jewellery items to the practice of Berber and Touareg culture members wearing a headscarf. This can be seen as a practical solution to protecting themselves from the harsh conditions of the desert, as need to keep safe from the strong sun and wind. At the same time, the so-called blue Moroccan, Touareg or Berber scarf is popular with Western culture members and a recognizable symbol of these cultures. The large jewelry items placed on women's heads can be seen as an extension of this practice. Western culture members may not be as used to wearing something on their heads at all times, as conditions of weather and seasons can vary and be different from those in Morocco. The national costumes



of Western cultures do not include such use of jewellery items as we can see in Fig. 1 and 2. In fact, in Fig. 1 and 2 the jewellery items are part of the traditional costume, the same way that head scarves with specific designs and motifs, or specific blouses and belts are part of the traditional costumes for women in Romanian culture. The traditional costumes include, thus, cultural products specific to the respective country, such as, in the case of Moroccan culture, jewellery items, or, in the case of Romanian culture, specific cloths designs and weaving techniques.

In Fig. 2, the hearwear made of jewellery items is not the only example of jewellery the young woman wears. She is also wearing chunky necklaces and large, numerous, as well as long jewellery items:



Fig. 2. Touareg woman wearing traditional jewellery. Image source:

<https://ro.pinterest.com/pin/454371049892169013/>

Fig. 3 shows a headwear made of jewellery meant for a special occasion, a wedding:



Fig. 3. Touareg bridal headwear. Image source:

<https://www.etsy.com/listing/1034729431/handmade-african-tuareg-bridal-headband>

Western culture members are used to seeing women wearing veils during their wedding. Thus, the bridal headwear could be seen as an equivalent for the bride's veil which, in their case is made of lace.

Indian culture women also wear jewelry items on their head, as well as on their ankles and toes, as we can see in Fig 4a and 4b below:



Fig. 4. Indian woman wearing jewellery. 4a – Head jewellery and necklace. 4b – Ankle bracelets and toe rings. Images source: <https://www.augrav.com/blog/science-behind-wearing-indian-jewellery>

At the same time, we can see the young Indian woman in Fig 4a wearing a nose jewel which, in Western cultures, is not associated with tradition but, on the contrary, with a rebellious attitude against all traditional lifestyle and women's role. In Western culture, nose jewels are related to a deviant attitude from conformism to society, and such young girls join subcultures and disregard the mainstream culture where they do not find themselves. Meanwhile, in Indian culture, this type of jewellery item is considered part of the tradition and not at all out of place. The ankle bracelets in Western cultures have been adapted as a sign of creativity and differing from the crowd.

For Indian women, nose pin or nose jewellery items have to do with acupuncture points, and they are believed to help keep their emotions in control and to improve their fertility (Augrav.com, 2020).

According to Augrav.com (2020), the toe rings are worn by married Indian women, throughout their lives, and they are worn in pairs, placed on the second toe of each foot. These rings are made of silver.

Bangled, earrings and rings are related to pressure points in the body as well, and they are believed to improve blood circulation and to bring benefits to body health (Augrav.com,





2020).

For Indian jewellery items, the metals used also have specific meanings. For instance, according to Augrav.com (2020), it is believed that gold has the power to purify anything it touches” and, additionally, it is a symbol of health, of prosperity, power, wealth and also of femininity. According to Augrav.com (2020), silver is a metal that is protective against negative energies and magic, a symbol of femininity, as well as of motherhood.

The symbolism of jewellery items wearing in Moroccan and Indian cultures will be considered, in order to understand, further, the differences between these cultures and Western cultures with respect to the perspectives offered on jewelry items. Any perspective and perception should be related from a cultural point of view with respect to symbols and practices such as the ones related to jewelry items. Jewelry items have different meanings in different cultures, and we can see this when looking at the specific cases of Moroccan, Indian, and Western cultures.

So far the meanings of the jewelry items have been related to cultural identity and spiritual symbolism, as well as social symbolism, related to special events in personal lives, e.g. weddings, when women in Moroccan and Indian cultures wear lots of jewelry items. For Moroccan women, the jewelry items passed down from their family’s older generations and other gifts are there to protect them, as well as to offer them means of supporting their family if they need money. For Indian women, jewelry items are there to measure how happy they are and to allow them to experience spirituality and well being with respect to the beneficial energies from their chakras. Additionally, for Indian women jewelry items are there as tokens for ensuring their femininity and fertility.

Various areas of life are related in a strong way to wearing jewelry items for the women of Moroccan culture. Thus, according to Maayaz.com (2018), the members of Berber culture are also called the “free people” through the term Amazighs, and these people make up about 50% of Morocco’s population. Silver jewelry is part of the Berber and Touareg women’s cultural identity (Loughran, 2003). The Berber women can be understood as defining themselves through the following combination of jewelry items: “necklaces, headbands, earrings and bracelets” (Maayaz.com, 2018). At the same time, the Berber women have in mind the following understandings of wearing jewelry items: those related to “symbolic and mythical meaning,” showing ways in which jewelry items can bring well-being, or protection



from the evil eye, prosperity, and fertility, those related to “emotional meaning,” such as connecting between mother and daughter, through passing on jewelry items, those related to “economic meaning,” showing how women in Berber culture can help with supporting family by selling jewelry items and buying, instead, cattle and lands, and those related to “socio-cultural meaning,” which refers to the ways in which jewelry items can make the difference between various Moroccan tribes and areas and, thus, differentiate between identities within these communities (Maayaz.com, 2018). Here we can see how jewelry items are symbols of these women’s defining themselves, as far as their personal and socio-cultural identity is concerned, as well as providing them with solutions to everyday, practical life issues, in case they need money or cattle to survive. The symbolic protection of the jewelry items can be related to a real-life, practical meaning. The connection with older family members through receiving jewelry items from them is also part of a ritual performed in order for them to maintain ties with the community’s practices and cultural identity.

We can tie the wearing of lots of jewelry by women in Moroccan and Indian cultures to ritualistic dimensions. Just like Berber women, Indian women wear lots of jewelry items during their wedding. According to Sharma (2022), this is part of their religion, Hinduism. Jewelry items are also worn in Indian culture during the practice of worship (and which is called, in their language, *puja*). Indian women also receive jewellery items as gifts on entering the extended family as brides (Kaur & Joseph, 2012). Once young women borrow jewellery items or receive them as gifts when they are brides, they are helped to go through the purification and transformation into the “extended self” of the bridegroom and become accepted by the extended family (Kaur & Joseph, 2012). According to Kaur & Joseph (2012), the young women in Indian culture wear jewellery as part of the sacred, religious, as well as part of the everyday, or profane life. They will be protected and blessed by their gods and goddesses. For Indian culture women, wearing jewellery items shows that they are “comfortable with the temporal co-existence of sacred and profane meanings” (Kaur & Joseph, 2012)

Indian culture also holds the belief that wearing certain jewelry items can protect from evil, e.g. the bangles worn by Indian women have such properties (Sharma, 2022). Economic aspects of jewelry are also present in Indian culture. As an example, jewelry items can even be used as forms of currency (Sharma, 2022).



The fact that Indian women are strongly attached to their traditions is visible in the way in which they prefer a traditional or family jeweller to readymade jewellery, since they attach to traditional or family jewellers' work emotional and sentimental values (Shah & Sidhpuria, 2018).

We can see emotional attachment to jewellery items in any culture, function of from whom the respective item was received, yet not to the same extent as in Indian and Moroccan cultures, which have made it an identity reinforcement tradition.

## RESULTS

Both Moroccan and Indian culture have a deeply rooted tradition related to both crafting and wearing specific jewelry items, which distinguish them from the Western culture to which the author of the present paper belongs to, as well as other members of Western cultures. Their distinctive jewelry items, their specific ways of wearing them, and their connection with various traditions and their religion are ways in which our understanding of these jewelry items can lead to cultural awareness related to the way of life of Moroccan and Indian culture women.

We can see jewelry in the specific style to Moroccan and Indian cultures as very symbols for these cultures. They are part of the lives of these cultures' members, part of religious worship, and of the way they relate their personal lives' events such as marriages, in both Morocco and India, and religious worship, in India.

Protection from evil is a common property of jewelry items in both cultures. Additionally, using jewelry items for trade or even currency is another common element. Cultural identity and use for social purposes are further common elements. We notice how these two cultures have, through tradition and religious rituals, a feature of decorating the body with jewelry items which is not present in Western, Christian cultures. Moroccan and Indian cultures sound very strongly connected with life here on Earth, and with celebrating the human body and, in the case of Indian culture, feeling in harmony with a woman's sensations in the body due to the connection of jewelry items' placing and chakras. The Berbers are also in harmony with their bodies due to the traditional religions which were influenced, next to local beliefs, by contact with other cultures' religions, e.g. ancient Egyptian, Punic, Judaism, Iberian



mythology, as well as Hellenistic religion. Afterwards, Berbers converted to Islam.

Thus, we can see that life here on Earth and its various aspects and stages are not considered separate from spirituality, as has been the case frequently with Western cultures' religions, where people used to prepare for life in the afterworld and not completely enjoy life here. This influence of Middle Ages religious beliefs can still be felt in the way the body is treated. Riches are considered a sin, and body needs and sensations are subject of feelings of guilt. Precious items such as jewels can be considered symbols for greed, which is another sin, and part of the material world and wishes only, with no connection to spirituality.

## **DISCUSSION**

We could claim that jewelry items and the way we relate to them in various cultures can show certain distinctive aspects about our cultures. Especially when it comes to jewelry items that are chunky and standing out, we could claim that, for Western cultures, these are reworked as symbols and adapted to the needs of individualist societies. In the meantime, for collectivist cultures where tradition is important to connect to the community and to the identity a certain culture can assign to members of the community in a collectivistic society, the same jewelry items function as a means of ensuring the idea that spirituality, happiness, and connection to the past, to the previous generations, and cultural identity are all ensured.

Function of our mindset as members of certain cultures, we could claim that we relate to various cultural products, such as jewelry items in our case, differently. For Western, individualist cultures, jewelry items are personal items, having personal meaning, not collective meaning. They are part of our personal perception and fashion style. This could have to do with the way we perceive our body and its decorations, tattoos included, due to the religion that is prevalent in our cultures. Spiritual life differs from one culture to another, and it can be seen as symbolized through various items, jewelry included, or, on the contrary, seems as incompatible with jewelry items. For some cultures, such as Moroccan and Indian, jewelry items can be related to spiritual and emotional meanings related to collectivist values. For Western cultures, body adornments are not at all related to spirituality and religious faith, as their religious practices move away the attention from everything having to do with this world, including the physical body and aesthetic practices of all kinds. In the meantime, henna



tattoos meant to adorn the body in Indian culture and chunky jewelry items in Indian and Moroccan cultures can be connected with spirituality, at the level of religion, as well as family and society. Some jewelry items are passed on from one generation to another, which can ensure a type of spiritual, emotional connection between different generations. Different rituals, both personal and community, religion-based such as marriage, may include, for women, wearing jewellery items in Moroccan and Indian cultures, to a larger extent than in Western cultures. Then, the emotional meaning of the personal event merges with the cultural, collectivist meaning and individuals become part of their culture's traditions.

The topic of the present paper is relevant since the practice related to including jewelry items in various rituals, traditions and practices and considering them as symbols for a culture are not exclusive to Moroccan and Indian cultures. Western culture members have become fascinated with these cultural products from Morocco and India, and have taken over and adapted wearing them, to some extent. These Moroccan and Indian culture jewelry items have been included in fashion shows as accessories and popularized as fashionable jewelry items to wear, of course not from head to toe, but a few items at a time. Chunky ethnic necklaces and large bracelets are considered statement jewelry, together with large earrings. We can see this as part of the communication among culture, as well as part of the soft power, or cultural products appeal of a certain culture for another.

## CONCLUSION

Jewelry items are a distinctive feature of Moroccan and Indian cultures. They are not simple accessories, but part of an emotional and cultural heritage as well. The members of Moroccan and Indian culture invest a lot emotionally and spiritually in their jewelry items. They become part of personal life landmarks such as marriage and approval of, as well as connection with, their older generations of their family and with their culture's traditions. They become part of family tradition once we are speaking about the practice of jewelry making craft. The techniques of jewelry making relate to cultural heritage, as well as to learned techniques passed down from one generation to another, over time. Jewelry items for Moroccan and Indian cultures are not simple merchandise and aesthetically pleasing objects, but they are also part of religious practices and part of connection with one's own body. The jewelry items are signs of the wearer being in harmony with cultural identity, family, personal body and



status of femininity, as well as with responsibility for one's own family, as jewelry items can be traded or serve as currency in case of need to survive.

## REFERENCES

- Augrav.com. (2020). Science Behind Wearing Indian Jewellery. Retrieved from: <https://www.augrav.com/blog/science-behind-wearing-indian-jewellery>
- Baciu, S. (2013). Culture. An Awareness-Raising Approach. Cavallioti Publishing House, Bucharest, Romania.
- Bernasek, L. (2008). *Artistry of the everyday: beauty and craftsmanship in Berber art* (Vol. 2). Harvard University Press.
- Hofstede, G. (2011). Dimensionalizing cultures: The Hofstede model in context. *Online readings in psychology and culture*, 2(1), 8.
- Kaur, P., & Joseph, R. (2012). Women And Jewelry-The Traditional and Religious Dimensions of Ornamentation. *Coherence*, 3, 39-49.
- Loughran, K. (2003). Jewelry, fashion, and identity: the Tuareg example. *African arts*, 36(1), 52-68.
- Maayaz.com. (2016). Berber Jewelry Making Techniques. Retrieved from: <https://maayaz.com/blogs/news/berber-jewelry-making-techniques>
- Maayaz.com. (2018). Berber Jewelry Empowering Berber Women. Retrieved from: <https://maayaz.com/blogs/news/berber-jewelry-empowering-berber-women>
- Nye, J. (2017). Soft power: the origins and political progress of a concept. *Palgrave communications*, 3(1), 1-3.
- Shah, D., & Sidhpuria, M. V. (2018). A Study on Womens Preference, Perception and Attitude towards Jewellery Buying. *Global Journal of Research in Management*, 8(2), 1.
- Sharma, Arti. (2022). Indian Jewellery. Retrieved from: <https://www.sneharateria.com/blogs/news/ndian-jewellery>



## YEŞİL ÇAY EKSTRAKTININ ELEKTROSTATİK EKSTRÜZYON TEKNİĞİ İLE ENKAPSÜLASYONU

### ENCAPSULATION OF GREEN TEA EXTRACT BY ELECTROSTATIC EXTRUSION TECHNIQUE

**Öğr. Gör. Dr. Sevinç TAY**

Malatya Turgut Özal Üniversitesi

ORCID NO: 0000-0002-9843-909

**Prof. Dr. Murat YILMAZTEKİN**

İnönü Üniversitesi

ORCID NO: 0000-0002-5667-9169

#### ÖZET

Yeşil çay, *Camellia sinensis* yapraklarının, siyah çay ve oolong çaya göre çok az fermente edilmesi veya hiç fermente edilmemesi ile elde edilen bir üründür. Yeşil çayın bileşimindeki polifenollerden dolayı siyah ve oolong çaya kıyasla daha iyi sağlıksal etkilere sahip olduğu bilinmektedir. Bu sağlıksal etkilerden dolayı yeşil çay polifenollerini fonksiyonel gıda üretmek amacıyla çeşitli gıda ürünlerine eklenmektedir. Ancak fonksiyonel gıda üretiminde söz konusu biyoaktif bileşenlerin gıdaların işlenmesi ve depolanması esnasında karşılaşılan şartlar altında (sıcaklık, oksijen, pH, ışık, enzimlerin etkisi gibi) veya gastrointestinal sistemde stabil olmadığı, degradasyona/epimerizasyona uğradıkları bildirilmiştir. Bu durum polifenollerini de içeren nutrasötik ürünlerin bahsedilen potansiyel sağlık etkilerini ve aktivitelerini de sınırlandırmaktadır. Dolayısıyla bu biyoaktif bileşenlerin hedeflediği fizyolojik etkileri gösterebilmesi için bir takım koruyucu mekanizmalara ihtiyaç vardır. Bu amaçla yeşil çay polifenollerinin biyoyararlılığının korunabilmesinde nanoteknolojik yöntemler yeni ve gelecek vadeden yöntemler olarak görülmektedir. Enkapsülasyon ise bu yenilikçi yöntemlerden biridir.

Bu çalışmada lokal marketlerden temin edilen yeşil çayın su ile çift ekstraksiyonu (80°C’de, 8:200 (%w/v), 30 dk) gerçekleştirilmiş, sonrasında elde edilen ekstraktlar ile kaplama materyali olarak %3.5 ve %4.5 (%w/v) konsantrasyonlarda soduyum aljinat kullanılarak 30 ve 60 dk’lık jelasyon sürelerinde elektrostatik ekstrüzyon tekniği ile hidrojel mikrobuncuklar elde edilmiştir. Kaplama materyali konsantrasyonunun ve jelasyon süresinin başta enkapsülasyon etkinliği olmak üzere elde edilen mikrobuncukların karakterizasyonu üzerindeki etkileri araştırılmıştır.

Çalışmamız sonucunda üretilen hidrojel mikrobuncukların enkapsülasyon etkinliklerinin (%EE) %38.93-78.32 arasında olduğu, kaplama materyali konsantrasyonunun ve jelasyon süresinin enkapülasyon etkinliği üzerinde etkili faktörler olduğu tespit edilmiştir ( $P<0.05$ ). Konsantrasyondaki ve jelasyon süresindeki artışa bağlı olarak enkapsülasyon etkinliklerinin



arttığı saptanmıştır. Elde edilen liyofilize mikroboncukların hacim ağırlıklı ortalama çaplarının 362.90- 406.13  $\mu\text{m}$  arasında olduğu, kaplama materyali konsantrasyonunun ve jelasyon süresinin artışının elde edilen mikroboncukların ortalama çaplarını arttırdığı saptanmıştır. Elektrostatik ekstrüzyon ile enkapsülasyon geleneksel enjeksiyon metoduna kıyasla daha küçük mikroboncuk eldesi sağlamıştır. Elde edilen tüm yaş hidrojel mikroboncukların optik mikroskop görüntülerinde oldukça küresel ve homojen boyutlarda olduğu saptanmıştır. Küresel mikroboncukların farmakoloji ve gıda ürünlerinde ürünlerin estetik kalitesini arttırması, kontrollü salınımın gerçekleştirilmesi ve jel boncuk mukavemetinin daha yüksek olması sebebiyle elde edilen mikroboncukların mekanik ve kimyasal stabiliteilerinin yüksek olduğu söylenebilir. Hidrojel mikroboncukların termal davranışı incelendiğinde ise enkapsülasyonun termal bozunma sıcaklığını yükselttiği ve yeşil çay ekstraktının termal stabilitesini arttırdığı düşünülmüştür.

**Anahtar Kelimeler:** Enkapsülasyon, Yeşil Çay, Elektrostatik Ekstrüzyon.

## ABSTRACT

Green tea is a product obtained by fermenting the leaves of *Camellia sinensis* with little or no fermentation compared to black tea and oolong tea. It is known that green tea has better health effects compared to black and oolong tea due to the polyphenols in its composition. Because of these health effects, green tea polyphenols are added to various food products to produce functional foods. However, in functional food production, it has been reported that the bioactive components are not stable under the conditions encountered during the processing and storage of foods (such as temperature, oxygen, pH, light, the effect of enzymes) or in the gastrointestinal tract and they can undergo degradation/epimerization. This also limits the potential health effects and activities of nutraceutical products containing polyphenols. Therefore, a number of protective mechanisms are needed in order to show their targeted physiological effects for these compounds. For this purpose, nanotechnological methods are seen as new and promising methods in preserving the bioavailability of green tea polyphenols. Encapsulation is the one of these innovative methods.

In this study, double extraction with water (80°C, 8:200 (%w/v), 30 min) of green tea obtained from local markets was performed, afterwards hydrogel microbeads were obtained by electrostatic extrusion technique at 30 and 60 min gelation times by using 3.5% and 4.5% (w/v) concentrations of sodium alginate as coating material with the extracts obtained. The effects of coating material concentration and gelation time on the characterization of the obtained microbeads, especially the encapsulation efficiency, were investigated.

As a result of our study, the encapsulation efficiency (%EE) of the hydrogel microbeads produced was between 38.93-78.32%, it was determined that the coating material concentration and gelation time were effective factors on the encapsulation efficiency ( $P<0.05$ ). It was





determined that encapsulation efficiencies increased depending on the increase in concentration and gelation time. The volume-weighted average diameters of the lyophilized microbeads obtained were between 362.90 and 406.13  $\mu\text{m}$ , it was determined that increasing the coating material concentration and gelation time increased the mean diameters of the microbeads obtained. Encapsulation with electrostatic extrusion yielded smaller microbeads compared to the traditional injection method. All wet hydrogel microbeads obtained were found to be quite spherical and homogeneous in optical microscope images. It can be said that the mechanical and chemical stability of the microbeads obtained is high due to the fact that spherical microbeads increase the aesthetic quality of the products in pharmacology and food products, the controlled release is realized and the gel bead strength is higher. When the thermal behavior of the hydrogel microbeads was examined, it was thought that encapsulation increased the thermal decomposition temperature and increased the thermal stability of the green tea extract.

**Key words:** Encapsulation, Green Tea, Electrostatic Extrusion.



## ERKEN ÇOCUKLUK EĞİTİMİNDE FELSEFİ DÜŞÜNME: P4C İLE ELEŞTİREL DÜŞÜNME BECERİLERİNİN GELİŞTİRİLMESİ

PHILOSOPHICAL THINKING IN EARLY CHILDHOOD EDUCATION: DEVELOPING  
CRITICAL THINKING SKILLS WITH P4C

**Dr. Bahar YAKUT ÖZEK**

Milli Eğitim Bakanlığı, Ankara, Türkiye

ORCID ID: 0000-0001-7699-8741

### ÖZET

Bu araştırma, okul öncesinde eleştirel düşünme becerilerinin geliştirilmesinde "Philosophy for Children (P4C)" ve erken çocukluk eğitim yaklaşımlarının birleştirilmesine odaklanmaktadır. Çocukların bilişsel ve duygusal gelişiminde, okul öncesi dönem temel bir aşamadır. Çocuklara erken çocukluk döneminde eleştirel düşünme becerilerinin kazandırılması, çocukların ilerleyen yıllarda da karşılaştıkları öğrenme deneyimlerinde analitik düşüncelerine olanak sağlayacak ve düşünsel kapasitelerini artıracaktır. Bu çalışmada, P4C'nin temel prensipleri ve erken çocukluk eğitimi yaklaşımları irdelenerek, bu iki alanın nasıl birleştirilebileceği ve çocukların eleştirel düşünme yeteneklerini nasıl güçlendirebileceği tartışılacaktır.

Matthew Lipman tarafından geliştirilen P4C, çocuklara felsefi düşünme becerileri kazandırmayı amaçlayan bir eğitim yaklaşımıdır. Bu yaklaşım, sadece belli bir konu ya da müfredat üzerine odaklanmak yerine, genel düşünme becerilerini geliştirmeyi hedefler. P4C seansları, öğrencilere bir konu hakkında düşünceleri, konuşmaları ve sorular sormaları için düşünsel bir ortam sunar. Bu süreç, çocukların eleştirel düşünme, problem çözme ve iletişim becerilerini güçlendirmelerine katkıda bulunur.

Bu bağlamda araştırma, nitel araştırma yöntemlerinden fenomenoloji yaklaşımı ölçüt alınarak tasarlanmıştır. P4C ve erken çocukluk eğitim yaklaşımlarına yönelik alanyazın temel alınarak araştırmacılar tarafından yarı yapılandırılmış görüşme formu geliştirilmiştir. İki alan uzmanı, bir ölçme değerlendirme uzmanı ve bir okutman tarafından görüşme formu değerlendirilmiş, alınan geri dönütlerle revize edilmiştir. Revize edilen form üzerinden iki okul öncesi öğretmenle pilot görüşme gerçekleştirilmiş ve forma nihai hali verilmiştir. Araştırmanın grubunu ise okul öncesi öğretmenliği yapan 15 öğretmen oluşturmaktadır. Bu öğretmenlerle



yapılan görüşmeler neticesinde elde edilen veriler, içerik analizi ile irdelenecektir. Araştırmanın sonucunda ise, araştırmanın katılımcıları olan okul öncesi öğretmenleriyle gerçekleştirilen görüşmelerden, P4C ve erken çocukluk eğitimi uygulamalarının nasıl entegre edilebileceğine dair önemli bilgiler elde edileceği öngörülmektedir. Ayrıca okul öncesi öğretmenlerinin felsefi düşünme ile P4C ve erken çocukluk eğitimi yaklaşımlarının birlikte kullanılmasının çocukların düşünsel yeteneklerini artırma potansiyelini ortaya koyacağı düşünülmektedir. Böylelikle P4C ve erken çocukluk eğitim yaklaşımlarının okul öncesi dönemde öğrencilerin düşünsel becerilerinin gelişimindeki saha etkisi anlaşılmış olacaktır. Öğretmenlerin bu konudaki uygulamaları, zayıf ve güçlü gördüğü yanları tartışılacak, saha uygulamalarındaki deneyimlerden yola çıkılarak önerilerde bulunulacaktır.

**Anahtar kelimeler:** Erken çocukluk eğitimi, Philosophy for Children (P4C), eleştirel düşünme becerileri, erken çocukluk eğitim yaklaşımları.

## ABSTRACT

This research focuses on combining "Philosophy for Children (P4C)" and early childhood education approaches in developing critical thinking skills in preschool. Preschool period is a fundamental stage in children's cognitive and emotional development. Giving children critical thinking skills in early childhood will enable children to think analytically in the learning experiences they encounter in the following years and will increase their intellectual capacity. In this research, the basic principles of P4C and early childhood education approaches will be examined and how these two fields can be combined and how children can strengthen their critical thinking abilities will be discussed.

Developed by Matthew Lipman, P4C is an educational approach that aims to provide children with philosophical thinking skills. This approach aims to develop general thinking skills rather than focusing only on a particular subject or curriculum. P4C sessions provide students with an intellectual environment to think, talk and ask questions about a topic. This process contributes to children strengthening their critical thinking, problem solving and communication skills.

In this context, the research was designed by taking the phenomenology approach, one of the qualitative research methods, as a criterion. A semi-structured interview form was developed by the researchers based on the literature on PC4 and early childhood education approaches.



The interview form was evaluated by two field experts, an assessment and evaluation expert and an instructor, and was revised with the feedback received. A pilot interview was held with two pre-school teachers on the revised form and the form was given its final form. The group of the research consists of 15 teachers who teach preschool. The data obtained as a result of the interviews with these teachers will be examined with content analysis. As a result of the research, it is anticipated that important information will be obtained about how P4C and early childhood education practices can be integrated from the interviews conducted with preschool teachers who are the participants of the research. It is also thought that the use of philosophical thinking by preschool teachers together with P4C and early childhood education approaches will reveal the potential to increase children's intellectual abilities. Thus, the field effect of P4C and early childhood education approaches on the development of students' intellectual skills in the preschool period will be understood. Teachers' practices on this subject, their weaknesses and strengths will be discussed, and suggestions will be made based on their experiences in field practices.

**Key words:** Early childhood education, Philosophy for Children (P4C), critical thinking skills, early childhood education approaches.



## **EVOLUTION OF FORMULA ONE (F1) MOTORSPORTS AND ITS TOP-NOTCH ADVANCEMENT IN ENGINEERING INNOVATIONS ACROSS THE RACING INDUSTRY**

**Imoh Ime Ekanem**

ORCID ID: 0000-0002-8973-9260

Department of Mechanical Engineering, Akwa Ibom State Polytechnic, Ikot Osurua, PMB.  
1200, Nigeria.

**Aniekan Essienubong Ikpe**

ORCID ID: 0000-0001-9069-9676

Department of Mechanical Engineering, Akwa Ibom State Polytechnic, Ikot Osurua, PMB.  
1200, Nigeria.

**Eyo Sunday Abia**

ORCID ID: 0009-0008-7308-570X

Department of Electrical Engineering, University of Cross River State, Nigeria.

### **ABSTRACT**

Formula 1 (F1) motorsports is a highly competitive and globally recognized racing championship that has captivated audiences for decades. The championship showcases cutting-edge engineering and innovation, advancing the boundaries of automotive technology and generating substantial revenue. This study is based on a comprehensive review of scholarly articles and industry reports, highlighting the key aspects of F1 motorsports, its significance, technological innovation, economic impact, and controversies. It was observed that the sport serves as a platform for manufacturers to test and develop new technologies that eventually trickle down to road cars, contributing to advancements in the automotive industry. Moreover, the high-speed nature of F1 racing also attracts a massive global audience, making it a lucrative platform for sponsors and advertisers. For economic impacts, the findings revealed that F1 motorsport championship generates substantial revenue through ticket sales, broadcasting rights, merchandise, and sponsorships. In addition, host countries benefit from increased tourism and exposure, as F1 races attract fans from around the world. Additionally, the sport creates employment opportunities, both directly and indirectly, in various sectors such as hospitality, tourism, and event management. However, one of the major concerns of F1 motorsports is the environmental impact of the sport. The study revealed that carbon footprint associated with F1 races, including travel, energy consumption, and waste generation, has raised questions about the sustainability of the championship. Efforts have been made to address these concerns, such as the introduction of hybrid power units and initiatives to reduce emissions. Despite the advancements in technology, aerodynamics, safety measures and the role of teams and drivers, concerns regarding the environmental impact and financial disparities within the sport persist. Hence, efforts should be made to address these issues and ensure the long-term sustainability and fairness of F1 motorsports.

**Keywords:** Formula 1, motorsports, evolution, technological advancement, safety measures.

### **1. Introduction (Formula One in Perspective)**



Formula One (F1) is widely regarded as the pinnacle of motorsports, attracting millions of fans worldwide. It is also referred to as Formula 1 or F1, the most popular form of international motorsport (whose races are known as Grands Prix) for open-wheel single-seater formula racing cars licensed by the Fédération Internationale de l'Automobile (FIA). F1 has evolved into a highly competitive and technologically advanced sport, captivating audiences with its thrilling races and showcasing cutting-edge engineering. First and foremost, Formula One holds immense importance in the world of motorsports. It serves as a platform for teams and drivers to showcase their skills, pushing the boundaries of speed, precision, and innovation (Næss and Tjønndal, 2021). The sport has a rich history dating back to its inception in 1950, and it has since become a global phenomenon. F1 races are held in various countries, attracting a diverse range of fans and contributing to the sport's international appeal. One of the key aspects that sets F1 apart from other motorsports is its emphasis on technological advancements. The sport serves as a testing ground for automotive manufacturers and engineers to develop and refine cutting-edge technologies. From aerodynamics to hybrid power units, F1 has been at the forefront of innovation, driving advancements in the automotive industry as a whole. The constant pursuit of speed and efficiency has led to the development of ground-breaking technologies that eventually find their way into road cars, benefiting consumers worldwide (Alanazi, 2023). Furthermore, F1's global reach is unparalleled. The sport has a massive fan base, with millions of viewers tuning in to watch races both on television and at the circuits. The popularity of F1 extends beyond the race weekends, with fans engaging in discussions, debates, and analysis throughout the year. The sport's global appeal is evident in the diverse backgrounds of its drivers, who hail from various countries, adding to the excitement and fostering a sense of national pride among fans. Critics argue that F1's environmental impact and high costs make it an unsustainable sport (Mourao, 2018). However, it is important to note that F1 has taken significant steps to address these concerns. The introduction of hybrid power units and the ongoing focus on sustainability demonstrate the sport's commitment to reducing its carbon footprint. Additionally, efforts to control costs and promote financial stability have been implemented to ensure the long-term viability of the sport. Formula One motorsports is a highly significant and globally renowned sport that pushes the boundaries of technology and captivates audiences worldwide (Schneiders and Rocha, 2022). Its rich history, emphasis on innovation, and global reach make it a unique and thrilling spectacle. While concerns regarding its environmental impact and costs exist, F1 has taken steps to address these issues, ensuring its sustainability for years to come. As F1 continues to evolve, it will undoubtedly remain at the forefront of motorsports, captivating fans and driving technological advancements in the automotive industry.

## **2. Historical of Formula One (F1) Motorsports**

Formula One (F1) is widely regarded as the pinnacle of motorsports, attracting millions of fans worldwide. The origins of Formula One can be traced back to the early days of motorsport racing. In the late 19th and early 20th centuries, automobile races were organized primarily to test the capabilities of newly developed vehicles (Axelsson and Reinholdsson, 2022). These races were often held on public roads, attracting both participants and spectators. One of the earliest and most influential motorsport events was the Gordon Bennett Cup. Established in 1900, this international race aimed to promote the development of automobile technology. The competition involved national teams, with each country represented by three drivers. The Gordon Bennett Cup played a crucial role in shaping the future of motorsports, as it laid the foundation for the concept of national teams competing against each other (Næss, 2023). The



birth of Formula One can be attributed to the establishment of the Fédération Internationale de l'Automobile (FIA) in 1904. The FIA, the governing body for motorsports, was formed to regulate and organize international racing events. Its primary goal was to standardize rules and ensure fair competition among participants. In 1946, the FIA introduced a set of regulations known as Formula A. These regulations aimed to create a standardized framework for racing, including engine capacity limits, weight restrictions, and technical specifications (Lippi et al., 2007; Bopaiah and Samuel, 2020). Formula A laid the groundwork for what would later become Formula One. The inaugural Formula One World Championship took place in 1950. The championship was organized by the FIA and consisted of seven races held in Europe. The participating teams included renowned manufacturers such as Alfa Romeo, Ferrari, and Maserati. Giuseppe Farina, driving for Alfa Romeo, emerged as the first Formula One World Champion (Maurya, 2021). This historic event marked the beginning of a new era in motorsports, with Formula One becoming the premier international racing series. Over the years, Formula One has evolved and expanded its reach globally. The sport has witnessed technological advancements, rule changes, and the emergence of legendary drivers such as Juan Manuel Fangio, Ayrton Senna, and Michael Schumacher (Eichenberger and Stadelmann, 2009). Formula One has become a global phenomenon, attracting millions of fans and generating substantial revenue through sponsorships and broadcasting rights. The sport's popularity has led to the establishment of races in various countries, including iconic circuits such as Monza in Italy, Silverstone in the United Kingdom, and Monaco's street circuit. The historical origin of Formula One can be traced back to the early days of motorsport racing and the establishment of the FIA. The introduction of standardized regulations and the inaugural Formula One World Championship in 1950 marked significant milestones in the sport's evolution. Today, Formula One stands as the pinnacle of motorsports, captivating audiences worldwide with its high-speed thrills and technological advancements.

### 3. Technological Advancements in Formula One Motorsports

Formula One (F1) is a highly competitive and technologically advanced motorsport that has consistently pushed the boundaries of engineering and innovation, resulting in significant improvements in performance, safety, and sustainability. Over the years, F1 has witnessed significant technological advancements that have revolutionized the sport. Formula One (F1) motorsports have always been at the forefront of technological development and advancement. The key technological advancements in F1, highlighting their impact on the sport and the wider automotive industry are as follows:

- i. **Aerodynamics:** Aerodynamics plays a crucial role in F1, as it directly affects the performance and speed of the cars (Toet, 2013). The development of advanced aerodynamic technologies has been a game-changer in the sport. The introduction of wings, diffusers, and other aerodynamic components has significantly improved the downforce and stability of F1 cars, allowing them to achieve higher speeds and better cornering capabilities (Dominy and Dominy, 1984). These advancements have not only enhanced the performance of F1 cars but have also influenced the design of road cars, making them more aerodynamically efficient.
- ii. **Hybrid Power Units:** The introduction of hybrid power units (see Figure 1) in F1 has been a major technological breakthrough (Stępień, 2016). These power units combine a traditional internal combustion engine with energy recovery systems, such as kinetic energy recovery systems (KERS) and heat energy recovery systems (ERS). The hybrid power units have not only increased the overall power output of the cars but have also

improved fuel efficiency and reduced emissions (Boretti, 2018; Bopaiah and Samuel, 2021) This technology has had a significant impact on the wider automotive industry, encouraging the development of more sustainable and eco-friendly powertrain solutions.

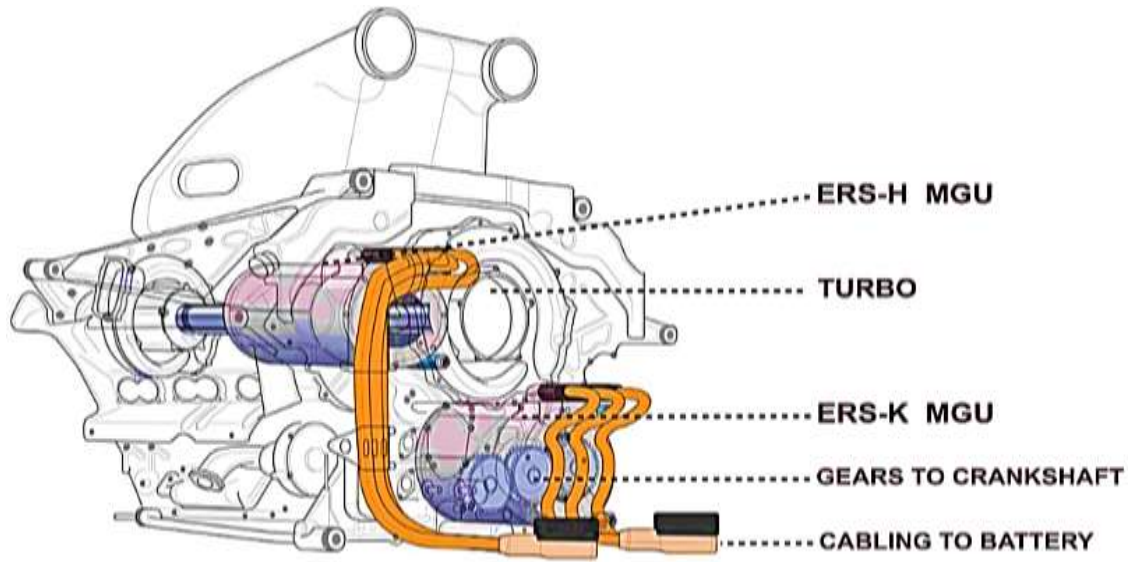

Figure 1: Hybrid power unit of F1 motorsport

- iii. **Data Analytics and Telemetry:** Data analytics and telemetry have revolutionized the way F1 teams analyse and optimize their performance (Berg, 2023). Advanced sensors and telemetry systems collect real-time data on various parameters, such as tire temperature, fuel consumption, and engine performance. This data is then analysed to make informed decisions regarding car setup, strategy, and driver performance (Aversa et al., 2018). The use of data analytics has not only improved the performance of F1 cars but has also influenced the development of data-driven technologies in road cars, enhancing safety and efficiency. Conventional data analytics and telemetry system is shown in Figure 2.

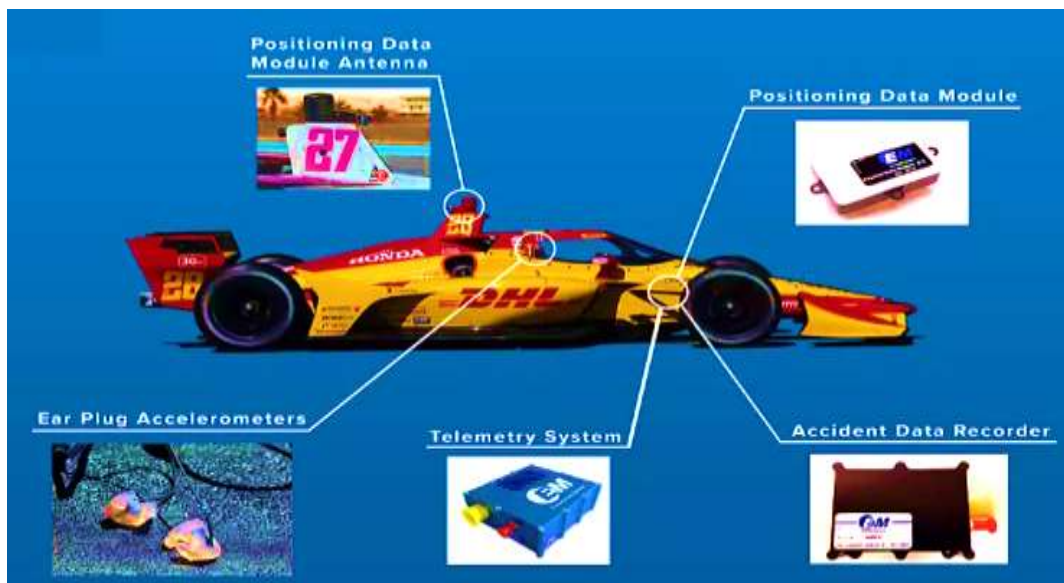





Figure 2: Conventional data analytics and telemetry system

- iv. **Composite Materials:** The use of lightweight composite materials, such as carbon fibre, has been a significant technological advancement in F1. These materials offer high strength-to-weight ratios, improving the overall performance and safety of the cars. Carbon fibre composites are used extensively in the construction of F1 chassis, bodywork, and other components, reducing weight and increasing rigidity. The adoption of composite materials in F1 has influenced the wider automotive industry, leading to the development of lighter and more fuel-efficient road cars (Savage, 2010; Kelly, 2002)
- v. **Enhanced Performance:** Technological advancements have greatly contributed to the enhanced performance of Formula One cars (Zhang, 2023). The introduction of advanced aerodynamics, such as the use of wings and diffusers, has significantly improved the cars' downforce, allowing them to generate more grip and achieve higher speeds through corners. Additionally, the development of lightweight materials, such as carbon fibre composites, has reduced the overall weight of the cars, resulting in improved acceleration and braking capabilities. Furthermore, the introduction of hybrid power units in 2014 marked a significant milestone in F1's technological development (Jenkins, 2010). These power units combine a highly efficient internal combustion engine with energy recovery systems, such as kinetic and heat energy recovery systems (KERS and HERS). This integration has not only increased power output but also improved fuel efficiency, making F1 cars more sustainable and aligned with the global push for greener technologies.
- vi. **Safety Innovations:** Technological advancements in F1 motorsports have also led to significant improvements in safety. Over the years, the sport has witnessed the introduction of various safety innovations, including the development of stronger and more impact-resistant chassis, advanced helmet designs, and improved fire-resistant materials. These innovations have played a crucial role in minimizing the risk of severe injuries and fatalities in high-speed accidents. One notable safety innovation is the introduction of the Halo device in 2018. The Halo is a titanium structure mounted above the cockpit, designed to protect the driver's head from flying debris and potential impacts (Bhatnagar, 2014; Aversa et al., 2015) This innovation has been widely praised for its effectiveness in preventing potentially fatal incidents, further highlighting the positive impact of technological advancements on driver safety.
- vii. **Driving Progress in the Automotive Industry:** Technological development and advancement in F1 motorsports have not only influenced the sport itself but have also driven progress in the wider automotive industry (Roig, 2021). The constant pursuit of performance improvements in F1 has led to the development of cutting-edge technologies that eventually find their way into road cars. For instance, advancements in aerodynamics, engine efficiency, and energy recovery systems have been adopted by automotive manufacturers to enhance the performance and sustainability of their production vehicles. Moreover, F1 serves as a testing ground for new technologies, allowing manufacturers to evaluate their reliability and performance under extreme conditions (Jenkins and Floyd, 2001; Henriksson, 2017). This rigorous testing environment enables engineers to identify potential weaknesses and refine their designs, ultimately leading to more reliable and efficient road cars.



Formula One has been at the forefront of technological advancements in the motorsport industry. Technological development and advancement in Formula One motorsports have played a pivotal role in shaping the sport, enhancing performance, improving safety, and driving progress in the automotive industry. The constant pursuit of innovation and the application of cutting-edge technologies have resulted in faster, safer, and more sustainable F1 cars. Furthermore, the transfer of these advancements to road cars has contributed to the overall progress of the automotive industry. As F1 continues to push the boundaries of technology, it will undoubtedly remain a driving force for innovation and advancement in the years to come. The advancements in aerodynamics, hybrid power units, data analytics, telemetry, and composite materials have not only improved the performance and safety of F1 cars but have also had a significant impact on the wider automotive industry. These technological breakthroughs have pushed the boundaries of engineering and innovation, making F1 a hotbed for cutting-edge technologies. As the sport continues to evolve, it is expected that further advancements will be made, shaping the future of both F1 and the automotive industry as a whole.

#### **4. Trends in Materials Used for Formula One (F1) Cars**

Formula One (F1) racing is a highly competitive motorsport that demands continuous innovation and development in various aspects, including the materials used in constructing the cars. Over the years, there has been a significant evolution in the materials employed in F1 car manufacturing, driven by the pursuit of enhanced performance, safety, and sustainability. (Larsen and Leicht, 2019). The trends and advancements in materials used for F1 cars, highlighting the key factors influencing their selection and the impact on the sport are highlighted as follows:

- i. **Lightweight Materials:** One of the primary objectives in F1 car design is to reduce weight while maintaining structural integrity. Lightweight materials, such as carbon fibre composites, have revolutionized the industry. Carbon fibre offers exceptional strength-to-weight ratio, allowing designers to create lighter and stiffer chassis, aerodynamic components, and bodywork (Hasan et al., 2023). The use of carbon fibre has significantly improved the overall performance of F1 cars, enabling higher speeds, improved handling, and increased fuel efficiency.
- ii. **Advanced Metals:** While carbon fibre dominates the F1 car construction, advanced metals like titanium and aluminium alloys still find their place in critical components (Wazeer et al., 2023). Titanium, known for its high strength and low density, is often used in suspension systems, gearbox casings, and exhaust components. Aluminium alloys, on the other hand, are employed in various parts, including engine blocks, transmission cases, and heat exchangers, due to their excellent thermal conductivity and lightweight properties. (Sayam et al., 2022; Czerwinski, 2021).
- iii. **Ceramic Matrix Composites (CMCs):** CMCs have gained attention in recent years due to their exceptional heat resistance and lightweight characteristics (Karadimas and Salonitis, 2023). These composites, consisting of ceramic fibres embedded in a ceramic matrix, are being explored for applications in F1 cars, particularly in the braking systems. CMCs offer improved braking performance, reduced weight, and enhanced durability, making them a potential game-changer in the future of F1 car materials.
- iv. **Sustainable Materials:** With the growing emphasis on sustainability, F1 teams are increasingly incorporating eco-friendly materials into their cars (Cioca et al., 2019). For instance, bio-based resins derived from renewable sources are being used in the



production of carbon fibre composites, reducing the environmental impact associated with traditional petroleum-based resins. Additionally, the use of recycled materials, such as recycled carbon fibre, is gaining traction, further promoting sustainability in F1 car manufacturing.

The evolution of materials used in F1 cars has been instrumental in pushing the boundaries of performance, safety, and sustainability in the sport. Lightweight materials like carbon fibre composites have revolutionized the industry, enabling faster speeds and improved handling. Advanced metals and ceramic matrix composites have also found their place in critical components, offering unique properties to enhance overall performance. Furthermore, the integration of sustainable materials showcases the sport's commitment to reducing its environmental footprint. As technology continues to advance, it is expected that further innovations in materials will shape the future of Formula One racing, making it even more thrilling and sustainable.

### **5. Future of Formula One Motor Sports**

Formula One (F1) motor sports have captivated audiences worldwide for decades, showcasing cutting-edge technology, high-speed racing, and intense competition. As one of the most prestigious and technologically advanced racing series, F1 has continuously evolved to meet the demands of the ever-changing automotive industry. However, as the world evolves, so too must F1 adapt to meet the demands of the future (Bagloee et al., 2016). The future of F1 lies in embracing sustainable practices, enhancing fan engagement through digital platforms, and expanding its global reach which are highlighted as follows:

- i. **Sustainable Practices:** One key aspect of the future of F1 lies in adopting sustainable practices. As concerns about climate change and environmental impact grow, it is imperative for F1 to reduce its carbon footprint (Sreenivasan and Suresh, 2023). The sport should invest in research and development to create more fuel-efficient engines, explore alternative energy sources, and promote the use of renewable materials in car manufacturing. By doing so, F1 can position itself as a leader in sustainable motor sports, attracting environmentally conscious sponsors and fans.
- ii. **Enhanced Fan Engagement:** Another crucial element for the future of F1 is enhancing fan engagement through digital platforms (Previati, 2020). With the rise of social media and streaming services, fans now expect real-time updates, interactive content, and behind-the-scenes access. F1 should leverage these platforms to provide fans with immersive experiences, such as live streaming of races (see Figure 3), interactive driver interviews, and virtual reality simulations. By embracing digital technologies, F1 can create a global community of passionate fans, fostering a deeper connection between the sport and its audience.



Figure 3: Cape Town F1 experience by Red Bull racing

- iii. **Global Expansion and Market Reach:** Expanding F1's global reach is also vital for its future success (Jensen et al., 2014). While F1 has traditionally been dominated by European races, there is immense potential for growth in untapped markets. By organizing races in emerging economies, such as India, China, and Brazil, F1 can tap into new fan bases and attract new sponsors. Additionally, F1 should actively promote diversity and inclusivity within the sport, encouraging participation from drivers of different nationalities and backgrounds. This will not only broaden the appeal of F1 but also reflect the global nature of the sport. While F1 is already a global phenomenon, there are still untapped markets and opportunities for expansion. The sport has traditionally been dominated by European teams and races, but there is immense potential for growth in other regions, such as Asia, the Americas, and the Middle East. Expanding the F1 calendar to include more races in these regions would not only attract new fans but also increase the sport's market reach and revenue streams. Furthermore, F1 can leverage digital platforms and social media to engage with a wider audience. By embracing new technologies and creating immersive digital experiences, F1 can connect with fans globally, regardless of their geographical location. This would not only enhance the sport's popularity but also provide new avenues for sponsorship and commercial partnerships.
- iv. **Environmental Responsibility:** In an era where environmental concerns are at the forefront of global discussions, F1 motorsports must adapt to become more environmentally responsible. The sport has already taken steps towards this goal by introducing hybrid power units and implementing various regulations to reduce carbon emissions (McCullough, 2023). However, there is still room for improvement. In the future, F1 can further enhance its sustainability by exploring alternative fuels, such as biofuels or hydrogen, which have lower carbon footprints. Additionally, the sport can invest in research and development to create more efficient engines and aerodynamic designs, reducing energy consumption and environmental impact. By embracing sustainability, F1 can not only secure its future but also contribute to a greener and more sustainable world.



- v. **Advancements in Technology:** One of the key factors driving the future prospects of F1 motorsports is the continuous advancements in technology (Yiyang, 2023). F1 has always been at the forefront of innovation, pushing the boundaries of engineering and design. With the introduction of hybrid power units in 2014, F1 has already taken a significant step towards sustainability and efficiency. However, the future holds even greater potential for technological advancements. The development of electric and autonomous vehicles has gained significant momentum in recent years. F1 can leverage this trend by incorporating electric power units and autonomous driving technologies into its racing cars. This would not only enhance the sustainability of the sport but also attract a new generation of fans who are passionate about clean energy and cutting-edge technologies.

The future of F1 lies in embracing sustainable practices, enhancing fan engagement through digital platforms, and expanding its global reach. The future prospects of Formula One motorsports are promising, driven by advancements in technology, sustainability efforts, and global expansion. By embracing electric power units, autonomous driving technologies, and sustainable fuels, F1 can stay at the forefront of innovation and attract a new generation of fans. Additionally, by expanding into new markets and leveraging digital platforms, F1 can increase its market reach and revenue streams. As the sport continues to evolve, it is crucial for F1 to maintain its commitment to professionalism, technological excellence, and environmental responsibility. By adopting sustainable technologies, F1 can position itself as a leader in environmentally friendly motor sports. Through digital platforms, F1 can create immersive experiences for fans, fostering a deeper connection with the sport. Finally, by expanding into new markets and promoting diversity, F1 can ensure its longevity and relevance in the ever-evolving world of motor sports. It is imperative for F1 to adapt and evolve to meet the demands of the future, securing its place as the pinnacle of motor racing.

## **6. Operation Principles Formula One Motorsports Work**

Formula One (F1) is a highly popular and prestigious motorsport that captivates millions of fans worldwide. This argumentative academic writing aims to explore the operation principles of Formula One motorsports. By delving into the key aspects of F1, including its technical regulations, race format, and team dynamics, the basic principles of how these aspects function with formula one motorsports are as follows:

- i. **Technical Regulations:** One of the fundamental operation principles of Formula One is the adherence to strict technical regulations. These regulations are designed to ensure fair competition and maintain safety standards. The Fédération Internationale de l'Automobile (FIA), the governing body of F1, establishes these regulations, which cover various aspects of the cars, including engine specifications, aerodynamics, and safety features (Lippi et al., 2007). The technical regulations dictate the dimensions, weight, and materials used in constructing the cars. They also outline the limitations on engine power, fuel consumption, and aerodynamic performance. By imposing these regulations, F1 aims to create a level playing field for all teams, preventing excessive spending and promoting innovation within defined boundaries.
- ii. **Race Format:** The race format in Formula One is another crucial aspect of its operation principles. A typical F1 race weekend consists of practice sessions, qualifying sessions, and the main race (Shields and Reavis, 2020) as shown in Figure 4. The practice

sessions allow teams and drivers to familiarize themselves with the track and fine-tune their cars' setups. The qualifying sessions determine the starting grid positions for the race based on the fastest lap times. The main race, usually held on Sundays, is the pinnacle of the race weekend. It consists of a predetermined number of laps, typically ranging from 50 to 70, depending on the circuit. The race distance is approximately 305 kilometres, although this can vary depending on the track layout. The winner is determined by the driver who completes all the laps in the shortest time, taking into account any penalties or disqualifications.



Figure 4: 2023 formula one sprint format

- iii. **Team Dynamics:** Formula One is not just about individual drivers; it is also a team sport. Each team consists of two drivers, engineers, mechanics, strategists, and other support staff. The team dynamics play a crucial role in the success of a Formula One outfit (Gordon, 2015). The engineers work closely with the drivers to develop and fine-tune the car's performance, ensuring it is competitive on the track. Strategists analyse data and make critical decisions during the race, such as pit stop timings and tire choices. Mechanics are responsible for maintaining and repairing the cars, both during the race weekend and between races. The collaboration and coordination among team members are essential for achieving optimal performance and securing victories.

Formula One motorsports operate based on several key principles. The technical regulations set by the FIA ensure fair competition and safety standards. The race format, consisting of practice sessions, qualifying sessions, and the main race, provides an exciting and competitive environment for drivers and teams. The team dynamics, involving engineers, mechanics, and strategists, contribute to the overall success of a Formula One outfit. Understanding these operation principles is crucial for appreciating the complexity and allure of Formula One motorsports.

## 7. Characteristics of Formula One (F1) Cars

Formula One (F1) cars are the pinnacle of automotive engineering, designed to deliver exceptional performance on the race track. These high-performance machines possess several unique characteristics that set them apart from regular road cars. The key characteristics of F1 cars, highlighting their aerodynamics, powertrain, and advanced technologies are as follows:

- i. **Aerodynamics:** One of the most distinctive characteristics of F1 cars is their aerodynamic design. These vehicles are meticulously crafted to minimize drag and maximize downforce, allowing them to maintain high speeds and cornering capabilities. The sleek and streamlined bodywork, combined with various aerodynamic elements such as wings, diffusers, and bargeboards, generate immense downforce, which helps keep the car glued to the track (Castro and Rana, 2020). The intricate aerodynamic design of F1 cars enables them to achieve remarkable levels of grip and stability, enabling drivers to navigate corners at high speeds. Aerodynamics play a crucial role in F1 racing cars, as they directly impact the car's speed and handling. Various aerodynamic enhancements, such as front and rear wings, diffusers, and bargeboards, are incorporated into F1 racing cars to optimize downforce and reduce drag. These enhancements enable the cars to maintain stability at high speeds and navigate corners more efficiently.
- ii. **Powertrain:** As shown in Figure 5, the powertrain of an F1 car is another crucial aspect that sets it apart from regular cars. These vehicles are equipped with highly advanced and powerful engines that produce an astonishing amount of horsepower (Kalociński et al., 2018). The current regulations stipulate the use of hybrid power units, which consist of a turbocharged V6 engine coupled with an Energy Recovery System (ERS). The ERS harnesses energy from the car's braking and exhaust systems, converting it into electrical energy that can be deployed for an additional power boost. This combination of a potent internal combustion engine and electric power assistance results in exceptional acceleration and top speeds, allowing F1 cars to reach 0-60 mph in under two seconds.

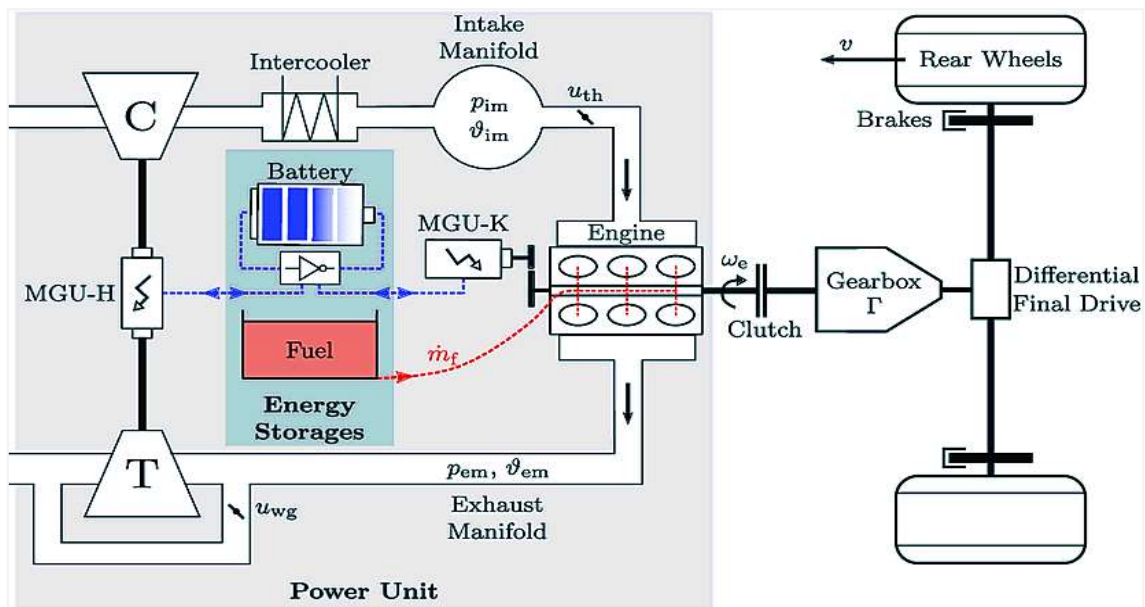

Figure 5: Components of the Formula 1 (F1) hybrid powertrain

- iii. **Advanced Technologies:** F1 cars are at the forefront of technological innovation, incorporating cutting-edge technologies to enhance performance and safety (Savage, 2010). These vehicles feature advanced telemetry systems that collect and transmit real-time data to the pit crew, enabling them to monitor various parameters such as tire wear, fuel consumption, and engine performance. This data helps teams make informed decisions during races, optimizing strategies and maximizing performance.



Additionally, F1 cars are equipped with state-of-the-art suspension systems, adaptive aerodynamics, and advanced braking systems, all aimed at improving handling, stability, and overall performance.

Formula One cars possess several unique characteristics that make them stand out from regular road cars. Their aerodynamic design, powertrain, and advanced technologies contribute to their exceptional performance on the race track. The aerodynamics of F1 cars enable them to generate immense downforce, providing exceptional grip and stability. The powerful hybrid power units deliver astonishing levels of acceleration and top speeds. Furthermore, the incorporation of advanced technologies enhances performance and safety, making F1 cars the epitome of automotive engineering. As the pinnacle of motorsport, Formula One continues to push the boundaries of automotive technology, ensuring that these remarkable machines remain at the forefront of innovation.

### **8. Rules and Regulations in Formula One (1) Motorsports**

Formula One (F1) is a highly competitive and globally recognized motorsport that captivates millions of fans worldwide. The sport's popularity can be attributed to its thrilling races, cutting-edge technology, and the skill of the drivers. However, to ensure fair competition and maintain safety standards, F1 has a comprehensive set of rules and regulations in place. The importance of rules and regulations in F1, highlighting their role in ensuring fair play, safety, and the overall success of the sport.

- i. **Fair Play:** One of the primary purposes of rules and regulations in F1 is to ensure fair play among all participants. The sport's governing body, the Fédération Internationale de l'Automobile (FIA), establishes and enforces these rules to create a level playing field for all teams and drivers. By setting limits on technical specifications, such as engine power, aerodynamics, and weight, F1 ensures that no team gains an unfair advantage over others. These regulations prevent teams from spending exorbitant amounts of money to gain a competitive edge, promoting fair competition based on skill and strategy. (Kaufmann-Kohler and Peter, 2001)
- ii. **Safety:** Safety is of paramount importance in any motorsport, and F1 is no exception. The high speeds, intense manoeuvres, and close proximity of cars on the track make safety regulations crucial. FIA's rules mandate the use of safety equipment, such as helmets, fireproof suits, and HANS (Head and Neck Support) devices, to protect drivers in the event of an accident. Additionally, the regulations govern track design, ensuring that circuits meet specific safety standards, including appropriate run-off areas, barriers, and safety car protocols. These measures significantly reduce the risk of serious injuries or fatalities, making F1 a safer sport for all participants.
- iii. **Technical Innovation:** F1 has always been at the forefront of technological advancements in motorsports. However, without regulations, teams could exploit these advancements to gain an unfair advantage, compromising the sport's integrity (Schneiders and Rocha, 2022). The rules and regulations in F1 strike a delicate balance between encouraging technical innovation and maintaining fair competition. For instance, the FIA sets limits on engine power, fuel consumption, and aerodynamic designs to prevent teams from creating excessively dominant cars. These regulations foster a competitive environment where teams must constantly innovate within defined boundaries, pushing the limits of technology while ensuring a level playing field.
- iv. **Spectator Experience:** Rules and regulations in F1 also play a crucial role in enhancing the spectator experience. By ensuring fair play and safety, these regulations contribute



to the overall excitement and unpredictability of the sport (Kim et al., 2013). Fans can be confident that the outcome of a race is determined by the skill and strategy of the drivers, rather than unfair advantages gained through rule violations. Moreover, safety regulations ensure that spectators can enjoy the races without worrying about the well-being of the drivers. This enhances the overall appeal of F1, attracting a larger audience and contributing to the sport's commercial success.

Rules and regulations are essential in Formula One (F1) motorsports. They promote fair play, maintain safety standards, encourage technical innovation, and enhance the spectator experience. By establishing and enforcing these regulations, the FIA ensures that F1 remains a highly competitive and thrilling sport, captivating millions of fans worldwide. The continuous evolution of these rules is crucial to adapt to technological advancements and changing safety requirements, ensuring the long-term success and sustainability of F1.

### 9. Types of Formula One (F1) Racing Cars

Formula One (F1) racing is a highly competitive motorsport that showcases the pinnacle of automotive engineering and technological advancements. It employs car with different geometries and sophisticated body parts (see Figure 6) that makes it suitable to withstand high crash impacts (Guerrero and Castilla, 2020).

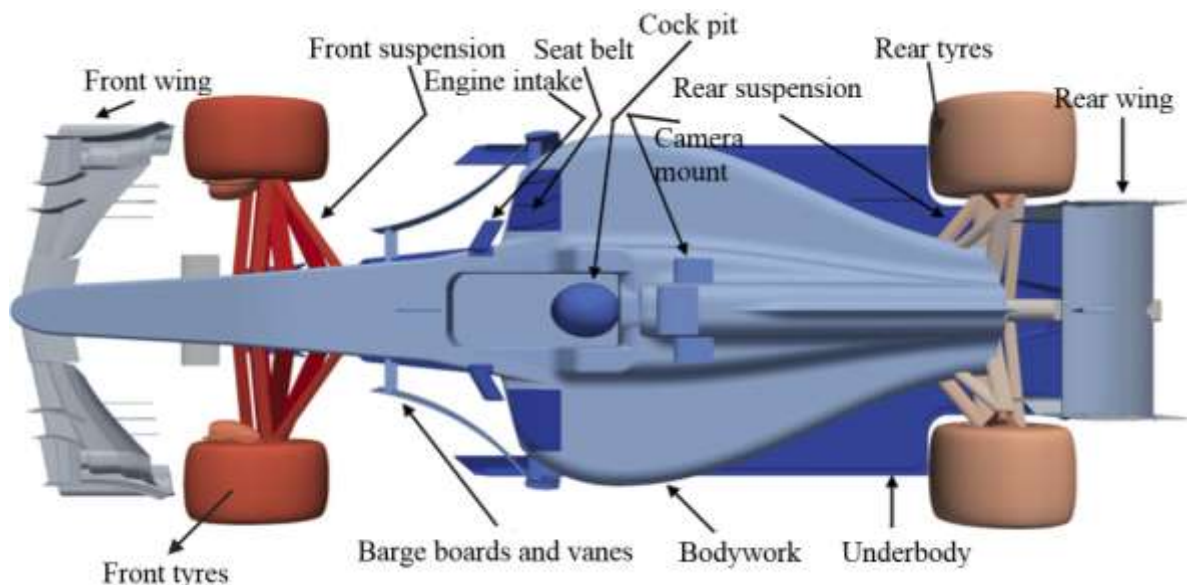

Figure 6: A typical F1 car components

The sport has evolved over the years, leading to the development of various types of F1 racing cars. The different types of F1 racing cars and their significance in the world of motorsports are as follows:

- i. **Open-Wheel Cars:** One of the most distinctive features of F1 racing cars is their open-wheel design. Open-wheel cars have exposed wheels, which enhance aerodynamics and manoeuvrability (Kachare, 2017). These cars are specifically designed for high-speed racing, allowing drivers to navigate corners and straights with precision. The open-wheel design also contributes to the overall aesthetic appeal of F1 racing cars.
- ii. **Monocoque Chassis:** F1 racing cars are built with a monocoque chassis, which is a structural component that provides rigidity and safety to the vehicle (Denny et al., 2018). The monocoque chassis is typically made of carbon fibre, a lightweight and



durable material that ensures the car's structural integrity. This type of chassis design offers enhanced safety for drivers, as it can absorb and distribute impact forces in the event of a crash.

- iii. **Hybrid Power Units:** In recent years, F1 racing cars have transitioned to hybrid power units, combining traditional internal combustion engines with electric motors. These power units are highly efficient and environmentally friendly, as they reduce fuel consumption and emissions (Stępień, 2016; Balerna et al., 2021). The hybrid technology also adds an element of strategy to the races, as drivers must manage their energy usage throughout the race.
- iv. **Turbocharged Engines:** Turbocharged engines have become a common feature in F1 racing cars (Boretti, 2020). These engines use a turbocharger to increase the amount of air entering the combustion chamber, resulting in improved power output. Turbocharged engines offer better acceleration and top speed, allowing drivers to achieve remarkable performance on the track. The introduction of turbocharged engines has significantly enhanced the competitiveness of F1 racing.

The world of Formula One racing is characterized by constant innovation and technological advancements. The different types of F1 racing cars discussed in this article highlight the evolution of the sport and the efforts made to enhance performance, safety, and sustainability. From open-wheel designs to hybrid power units and aerodynamic enhancements, each type of F1 racing car contributes to the overall excitement and competitiveness of the sport. As F1 continues to evolve, it is certain that further advancements will be made, pushing the boundaries of automotive engineering and captivating motorsport enthusiasts worldwide.

### **10. Advantages of Formula One (F1) Motorsports Championship**

Formula One (F1) is a prestigious motorsports championship that has captivated audiences worldwide for decades. From technological advancements to economic benefits and global exposure, Formula One has proven to be a valuable and influential sporting event. The advantages of Formula One motorsports, and its positive impact on various aspects of society are as follows:

- i. **Technological Advancements:** Formula One serves as a catalyst for technological advancements in the automotive industry. The intense competition among teams pushes engineers and designers to develop cutting-edge technologies, which eventually trickle down to consumer vehicles. For instance, advancements in aerodynamics, fuel efficiency, and safety features have been directly influenced by Formula One (F1) research and development. These innovations not only enhance the performance of race cars but also contribute to the overall progress of the automotive industry (Franke et al., 2023).
- ii. **Economic Benefits:** Formula One generates substantial economic benefits for host countries and local communities. The championship attracts millions of spectators, both in-person and through television broadcasts, leading to increased tourism and revenue generation. Studies have shown that the British Grand Prix alone contributes over £50 million to the local economy each year (Kim et al., 2017). Additionally, the event creates job opportunities in various sectors, including hospitality, transportation, and event management, further boosting the economy.
- iii. **Global Exposure:** Formula One provides unparalleled global exposure for host countries, sponsors, and participating teams (Rosenberger and Donahay, 2008; Zagnoli and Radicchi, 2009). The championship is broadcasted in over 180 countries, reaching billions of viewers worldwide. This extensive coverage not only promotes the host country's tourism and culture but also showcases its infrastructure and capabilities on



- an international stage. Moreover, sponsors and teams benefit from increased brand visibility and recognition, leading to potential business opportunities and partnerships.
- iv. **Promotion of Motorsports:** Formula One plays a crucial role in promoting motorsports and inspiring future generations of racers. The championship serves as a platform for young drivers to showcase their skills and gain recognition, opening doors to professional racing careers (Dylan, 2023). The popularity of Formula One also encourages investment in grassroots motorsports, leading to the development of local racing circuits and training facilities. This, in turn, fosters talent and creates a pathway for aspiring racers to pursue their dreams.

Formula One (F1) motorsports championship offers numerous advantages, ranging from technological advancements to economic benefits and global exposure. The championship's influence on the automotive industry, job creation, and tourism cannot be understated. Moreover, Formula One serves as a catalyst for innovation and inspires future generations of racers. As a result, it is evident that Formula One is not only a thrilling sporting event but also a valuable contributor to society as a whole.

### **11. Disadvantages of Formula One (F1) Motorsports Championship**

Formula One (F1) is a highly popular and prestigious motorsports championship that captivates millions of fans worldwide. However, despite its immense popularity, the F1 championship also has its fair share of disadvantages and drawbacks (Chung and Hwang, 2014). The key drawbacks associated with Formula One, highlighting the negative aspects of this motorsports championship are as follows:

**Environmental Impact:** One of the major drawbacks of Formula One is its significant environmental impact. The sport relies heavily on fossil fuels, with cars consuming large amounts of gasoline during races. This contributes to air pollution and greenhouse gas emissions, exacerbating climate change. Additionally, the construction and maintenance of F1 circuits often involve deforestation and land degradation, further harming the environment. For example, The Birmingham 2022 Commonwealth Games (see Figure 7) brought many benefits to the city but cost an estimated 240,000 tCO<sub>2</sub>e that will be offset over 35 years by new forest areas in the Midlands, UK (Wilby et al., 2023).





Figure 7: Birmingham 2022 commonwealth games

- i. **High Costs:** Formula One is an incredibly expensive sport, both for teams and spectators. The cost of designing, building, and maintaining F1 cars is exorbitant, making it difficult for smaller teams to compete on an equal footing. This financial burden also extends to fans who wish to attend races, as ticket prices, accommodation, and travel expenses can be prohibitively expensive. Consequently, this exclusivity limits the accessibility of the sport to a wider audience.
- ii. **Safety Concerns:** Despite significant advancements in safety measures, Formula One remains a dangerous sport. High-speed crashes and collisions can result in severe injuries or even fatalities for drivers. While safety regulations have improved over the years, accidents still occur, raising concerns about the well-being of participants. The inherent risks associated with F1 racing cannot be overlooked, and the potential for accidents remains a significant drawback of the championship (Ugle et al., 2015; Liu et al., 2019)
- iii. **Lack of Diversity:** Formula One has long been criticized for its lack of diversity, both in terms of drivers and team personnel. Historically, the sport has been dominated by male drivers, with limited opportunities for female participation (Sturm, 2021). Similarly, there is a lack of racial and ethnic diversity within the sport, with few drivers from diverse backgrounds. This lack of representation hampers the sport's ability to be inclusive and reflective of the wider population.
- iv. **Negative Impact on Local Communities:** Hosting Formula One races often requires significant infrastructure development, including the construction of new circuits and facilities. While this can bring economic benefits to the host country, it can also have negative consequences for local communities (Mao and Huang, 2016). Displacement of residents, increased traffic congestion, and disruption to daily life are common issues associated with hosting F1 races. Additionally, the short-lived nature of the event means that the economic benefits may not be sustainable in the long term.

While Formula One is undoubtedly an exciting and thrilling motorsports championship, it is important to acknowledge its drawbacks and disadvantages. The environmental impact, high costs, safety concerns, lack of diversity, and negative impact on local communities are all significant issues associated with the sport. As Formula One continues to evolve, it is crucial to address these drawbacks and work towards a more sustainable, inclusive, and socially responsible championship.

## 12. Conclusion and Recommendations

Formula One (F1) motorsports is a highly competitive and globally recognized sport that has captivated audiences for decades. It is a pinnacle of motorsports, attracting the best drivers, teams, and engineers from around the world. Through this academic study, various aspects of F1, including its history, technological advancements, and impact on the automotive industry have been explored. It is evident that F1 has evolved into more than just a sport, but also a platform for innovation and a showcase of engineering excellence. The championship consists of a series of races held on various circuits across different countries. The sport's popularity can be attributed to its high-speed races, cutting-edge technology, and the thrill it offers to both participants and spectators. One of the key aspects of F1 is the constant pursuit of innovation and technological advancements. Teams invest heavily in research and development to gain a



competitive edge. This has led to the introduction of ground-breaking technologies such as hybrid power units, aerodynamic advancements, and advanced data analytics. The sport serves as a testing ground for these innovations, which eventually trickle down to road cars, benefiting the automotive industry as a whole. However, F1 has not been without its controversies. The sport has faced criticism for its high costs, elitism, and environmental impact. The exorbitant budgets required to compete in F1 have led to a significant disparity between teams, making it difficult for smaller teams to remain competitive. Additionally, the environmental impact of F1, particularly in terms of carbon emissions, has raised concerns. Efforts have been made to address these issues, such as the introduction of hybrid power units and initiatives to reduce the sport's carbon footprint. While it has faced criticism for its high costs and environmental impact, F1 continues to push the boundaries of technology and serves as a platform for innovation in the automotive industry. Efforts to address these concerns are ongoing, ensuring that F1 remains a thrilling and sustainable motorsport for years to come. Based on the evaluation carried out in this study, the following recommendations are proposed to further enhance the Formula One motorsports:

- i. **Safety Measures:** Despite significant improvements in safety over the years, there is always room for further enhancement. F1 should continue investing in research and development to ensure the safety of drivers, spectators, and track personnel. This can be achieved through the implementation of advanced safety technologies, regular track inspections, and continuous driver training programs.
- ii. **Environmental Sustainability:** Formula One should prioritize environmental sustainability by adopting greener technologies and practices. This can include the use of hybrid or electric engines, promoting fuel efficiency, and reducing carbon emissions. F1 can also encourage the development of sustainable fuels and invest in renewable energy sources for powering the events.
- iii. **Cost Control:** Formula One teams operate on substantial budgets, which can create an imbalance in competition. Implementing cost control measures can level the playing field and make the sport more accessible to smaller teams. This can be achieved through the introduction of budget caps, standardized parts, and stricter financial regulations.
- iv. **Fan Engagement:** Formula One should focus on enhancing fan engagement to attract a wider audience and increase its global reach. This can be achieved through the use of social media platforms, interactive fan experiences, and more accessible ticket pricing. F1 should also consider expanding into new markets and hosting races in countries with a growing interest in motorsports.
- v. **Diversity and Inclusion:** Formula One should actively promote diversity and inclusion within the sport. Encouraging the participation of women and individuals from diverse backgrounds can bring fresh perspectives and talent to the sport. F1 should support initiatives that promote diversity in driver recruitment, team management, and leadership positions.

By implementing these recommendations, Formula One can continue to evolve and thrive as a leading motorsport, captivating audiences worldwide while promoting innovation, sustainability, and inclusivity.

## References



- Næss, H. E. and Tjønndal, A. (2021) *Innovation, Sustainability and Management in Motorsports: The Case of Formula E*. Palgrave Macmillan, Switzerland AG, ISBN: 978-3-030-74221-8.
- Alanazi, F. (2023) *Electric Vehicles: Benefits, Challenges, and Potential Solutions for Widespread Adaptation*. *Applied Sciences*, 13(10), 6016.
- Bagloee, S. A., Tavana, M., Asadi, M. and Oliver, T. (2016) *Autonomous vehicles: challenges, opportunities, and future implications for transportation policies*. *Journal of Modern Transportation*, 24, 284-303.
- Schneiders, C. and Rocha, C. (2022) *Technology Innovations and Consumption of Formula 1 as a TV Sport Product*. *Sport Marketing Quarterly*, 30, 186-197.
- Mourao, P. R. (2018) *Smoking Gentlemen-How Formula One Has Controlled CO<sub>2</sub> Emissions*. *Sustainability*, 10(6), 1841.
- Axelsson, E. and Reinholdsson, J. (2022) *Customer engagement in Formula 1- From an old man's club to social media behemoth*. Uppsala University, Sweden.
- Næss, H. E. (2023) *In Case of Dispute, the French Text is to be used: A History of the Association Internationale des Automobile Clubs Reconnus (AIACR), 1904–1922*. *The International Journal of the History of Sport*, 12 1-20.
- Lippi, G., Salvagno, G. L., Franchini, M., Guidi, G. C. (2007) *Changes in technical regulations and drivers' safety in top-class motor sports*. *British Journal Sports Medicine*, 41(12), 922-5.
- Bopaiah, K. and Samuel, S. (2020) *Strategy for Optimizing an F1 Car's Performance based on FIA Regulations*. Oxford Brookes University, Oxford, England.
- Eichenberger, R. and Stadelmann, D. (2009) *Who Is the Best Formula 1 Driver? An Economic Approach to Evaluating Talent*. *Economic Analysis & Policy*, 39(3), 389-406.
- Maurya, A. (2021) *Formula one (f1) Car: A Scientometric Study*. *International Journal of Advance Research and Innovative Ideas in Education*, 7(5), 22-28.
- Aerodynamics and aerodynamic research in Formula 1
- Toet W. (2013) *Aerodynamics and aerodynamic research in Formula 1*. *The Aeronautical Journal*, 117(1187), 1-26.
- Dominy, J. A. and Dominy, R. G. (1984) *Aerodynamic Influences on the Performance of the Grand Prix Racing Car*. *Proceedings of the Institution of Mechanical Engineers, Part D: Transport Engineering*, 198(2), 87-93.
- Stępień, Z. (2016) *A new generation of F1 race engines-hybrid power units*. *Combustion Engines*, 167(4), 22-37.
- Bopaiah, K. and Samuel, S. (2021) *Analysis of Energy Recovery System of Formula One Cars*. Auburn University, Alabama, USA, 1-14.
- Boretti, A. (2018) *Changes of E-KERS Rules to Make F1 More Relevant to Road Cars*. *Advances in Technology Innovation*, 3(1), 26-35.
- Berg, M. F., Døsvik, H., Skjølvik, K. Ø., Pedersen, T. S., Aasan, V., Steinert, M. and Eikevåg, S. W. (2023) *Wireless sensor system for real-time performance monitoring in sports*. *Front Sports Act Living*. 5, 1305117.
- Aversa, P., Cabantous, L. and Haefliger, S. (2018) *When Decision Support Systems Fail: Insights for Strategic Information Systems from Formula 1*. *The Journal of Strategic Information Systems*, 14, 1-33.



- Savage, G. (2010) Formula 1 Composites Engineering. *Engineering Failure Analysis*, 17(1), 92-115.
- Kelly, G. (2002) *Load Introduction in Carbon Fibre Composites for Automotive Applications*. Stockholm, Sweden.
- Zhang, Z. (2023) Study on aerodynamic development in Formula One racing. *Theoretical and Natural Science*, 14, 38-41.
- Jenkins, M. (2010) Technological Discontinuities and Competitive Advantage: A Historical Perspective on Formula 1 Motor Racing 1950-2006. *Journal of Management Studies*, 47(5), 884-910.
- Aversa, P., Furnari, S. and Haefliger, S. (2015) Business model configurations and performance: A qualitative comparative analysis in Formula One racing, 2005–2013. *Industrial and Corporate Change*, 24(3), 655-676.
- Bhatnagar, U. R. (2014) *Formula 1 Race Car Performance Improvement by Optimization of the Aerodynamic Relationship between the Front and Rear Wings*. The Pennsylvania State University, Pennsylvania.
- Roig, M. (2021) *Can Motorsport Act as a Catalyst in the Car Industry's Green Transition?* Geneva, Switzerland.
- Jenkins, M. and Floyd, S. (2001) Trajectories in the Evolution of Technology: A Multi-Level Study of Competition in Formula 1 Racing. *Organization Studies*, 22(6), 945-969.
- Henriksson, F. (2017) *Introducing New Materials in the Automotive Industry: Managing the Complexity of Introducing New Materials in Existing Production Systems*. Linköping University, Linköping, Sweden.
- Larsen, G. D. and Leicht, R. (2019) Driving innovation in construction organizations: a comparative case study of the design and construction of motor racing venues. In: *The 17<sup>th</sup> Annual Engineering Project Organization Conference – A Challenge Summit*, 25-27 Jun 2019, Vail, USA.
- Hasan, A., Lu, C. and Liu, W. (2023) Lightweight Design and Analysis of Steering Knuckle of Formula Student Car Using Topology Optimization Method. *World Electric Vehicle Journal*, 14(9), 233.
- Wazeer, A., Das, A., Abeykoon, C., Sinha, A. and Karmakar, A. (2023) Composites for electric vehicles and automotive sector: A review. *Green Energy and Intelligent Transportation*, 2(1), 100043.
- Sayam, A., Rahman, A. N., Rahman, M. S., Rahman, M. S., Smriti, S. A., Ahmed, F., Rabbi, M. F., Hossain, M. and Faruque, M. O. (2022) A review on carbon fiber-reinforced hierarchical composites: mechanical performance, manufacturing process, structural applications and allied challenges. *Carbon Letters*, 32, 1173–1205.
- Czerwinski, F. (2021) Current Trends in Automotive Lightweighting Strategies and Materials. *Materials*, 14(21), 6631.
- Karadimas, G. and Salonitis, K. (2023) Ceramic Matrix Composites for Aero Engine Applications—A Review. *Applied Sciences*, 13(5), 3017.
- Cioca, L. I., Ivascu, L., Turi, A., Artene, A. and Găman, G. A. (2019) Sustainable Development Model for the Automotive Industry. *Sustainability*, 11(22), 6447.
- Sreenivasan, A. and Suresh, M. (2023) Factors influencing sustainability in start-ups operations 4.0. *Sustainable Operations and Computers*, 4, 105-118.



- Previati, A. (2020) The Importance of Fan Engagement And Fan Management In Sports. ST. John's University, New York.
- Jensen, J. A., Cobbs, J. and Groza, M. D. (2014) The Niche Portfolio Strategy to Global Expansion: The Influence of Market Resources on Demand for Formula One Racing, *Journal of Global Marketing*, 27(4), 247-261.
- McCullough, B. P. (2023) Advancing sport ecology research on sport and the natural environment, *Sport Management Review*, 26(5), 813-833.
- Yiyang, M. (2023) Challenges and Opportunities in the Business Model of Formula 1. *Advances in Economics, Management and Political Sciences*, 26, 108-114.
- Lippi, G., Salvagno G. L., Franchini, M., Guidi, G. C. (2007) Changes in technical regulations and drivers' safety in top-class motor sports. *British Journal of Sports Medicine*, 41(12), 922-925.
- Shields, B. and Reavis, C. (2020) Formula 1: Unleashing the Greatest Racing Spectacle on the Planet. Cambridge, Massachusetts, 1-31.
- Gordon, B. R. (2015) Behind the Visor: A Qualitative Exploration of the Psychological Skills of Formula One Race Car Drivers. Temple University, Philadelphia, Pennsylvania.
- Castro, X. and Rana, Z. A. (2020) Aerodynamic and Structural Design of a 2022 Formula One Front Wing Assembly. *Fluids*, 5(4), 237.
- Kalociński, T., Rymaniak, Ł. and Fuć, P. (2018) Powertrain technology transfer between F1 and the automotive industry based on Mercedes-Benz. *Combustion Engines*, 172(1), 3-13.
- Kaufmann-Kohler, G. and Peter, H. (2001) Formula 1 Racing and Arbitration: The FIA Tailor-Made System for Fast Track Dispute Resolution. *Arbitration International*, 17(2), 173-210.
- Kim, S., Byon, K. K., Yu, J., Zhang, James J. and Kim, C. (2013) Social motivations and consumption behavior of spectators attending a Formula one motor-racing event. *Social Behavior and Personality: an international journal*, 41(8), 1359-1377.
- Kachare, S. C. (2017) A CFD Study of a Multi-Element Front Wing for a Formula One Racing Car. Grand Valley State University, Allendale, Michigan.
- Denny, J., Veale, K., Adali, S. and Leverone, F. (2018) Conceptual design and numerical validation of a composite monocoque solar passenger vehicle chassis. *Engineering Science and Technology, an International Journal*, 21(5), 1067-1077.
- Balerna, C., Neumann, M. P., Robuschi, N., Duhr, P., Cerofolini, A., Ravaglioli, V. and Onder, C. (2021) Time-Optimal Low-Level Control and Gearshift Strategies for the Formula 1 Hybrid Electric Powertrain. *Energies*, 14(1), 171.
- Boretti, A. (2020) Energy flow of a 2018 FIA F1 racing car and proposed changes to the powertrain rules. *Nonlinear Engineering*, 9(1), 28-34.
- Chung, K. and Hwang, G. (2014) Antecedents and consequences of Formula One spectators' fanship: The case of inaugural Grand Prix. *Journal of Physical Education and Sport Management*, 6(6), 38-46.
- Mao, L. L. and Huang, H. (2016) Social impact of Formula One Chinese Grand Prix: A comparison of local residents' perceptions based on the intrinsic dimension, *Sport Management Review*, 19:3, 306-318.
- Wilby, R. L., Orr, M., Depledge, D., Giulianotti, R., Havenith, G., Kenyon, J. A., Matthews, T. R., Mears, S. A., Mullan, D. J. and Taylor, L. (2023) The impacts of sport emissions on





- climate: Measurement, mitigation, and making a difference. *Annals of the New York Academy of Sciences*, 1519(1), 20-33.
- Liu, J., Li, J., Wang, K., Zhao, J., Cong, H. and He, P. (2019) Exploring factors affecting the severity of night-time vehicle accidents under low illumination conditions. *Advances in Mechanical Engineering*, 11(4), 1-9.
- Ugle, S. R., Kate, S. D. and Dolas, D. R. (2015) Formula One Safety: A Review. *International Research Journal of Engineering and Technology*, 2(7), 433-437.
- Sturm, D. (2021) The Formula One Paradox: Macho Male Racers and Ornamental Glamour 'Girls', Dashper, K. (Ed.) *Sport, Gender and Mega-Events (Emerald Studies in Sport and Gender)*, Emerald Publishing Limited, Leeds, 113-130.
- Franke, J., Wasserscheid, P., Ihne, T., Lamp, P., Guldner, J., Zipse, O. (2023) The Power of Technological Innovation. In: Zipse, O., et al. *Road to Net Zero*. Springer, Cham, Switzerland.
- Kim, K. K., Kim, S., Park, J., Carroll, M., Yu, J. and Na, K. (2017) Measuring the economic impacts of major sports events: the case of Formula One Grand Prix (F1), *Asia Pacific Journal of Tourism Research*, 22:1, 64-73.
- Rosenberger, P. J. and Donahay, B. (2008) Brand Personality Differentiation in Formula One Motor Racing: An Australian View. *Marketing Bulletin*, 19(2), 1-4.
- Zagnoli, P. and Radicchi, E. (2009) Do Major Sports Events Enhance Tourism Destinations? *Physical Culture and Sport Studies and Research*, 48, 44-63.
- Dylan, J. (2023) *What It Takes To Be The Best: The Competitive Balance In Formula 1 Racing*. Bard College, Annandale-on-Hudson, New York, 248.
- Guerrero, A. and Castilla, R. (2020) Aerodynamic Study of the Wake Effects on a Formula 1 Car. *Energies* 2020, 13(19), 5183.



## ÇALIŞAN VE ÇALIŞMAYAN KADINLARDA HEDONİK AÇLIK İLE AKDENİZ DİYETİNE UYUM ARASINDAKİ İLİŞKİNİN İNCELENMESİ

INVESTIGATION OF THE RELATIONSHIP BETWEEN HEDONIC HUNGER AND  
MEDITERRANEAN DIET IN WORKING AND NON-WORKING WOMEN

**Dyt. Uğur Sevim KALENDER**

Hasan Kalyoncu Üniversitesi

**Prof. Dr. Yasemin BEYHAN**

Hasan Kalyoncu Üniversitesi

ORCID NO: 0000-0002-5542-9301

### ÖZET

Bu çalışma, 18-65 yaş arası çalışan ve çalışmayan kadınlarda; hedonik açlık varlığı ile Akdeniz diyetine uyum düzeyinin; Beden Kütle İndeksi (BKI) ( $\text{kg}/\text{m}^2$ ), sigara kullanımı, alkol tüketimi, hızlı-hazır besin tüketimi ve öğün atlama gibi durumlar arasındaki ilişkiyi incelemek amacıyla planlanmış ve yürütülmüştür. Çalışmaya 200 kadın katılmıştır. Katılımcıların seçiminde çalışan ve çalışmayan kadınların sayısının eşit ve/veya yakın olmasına dikkat edilmiştir. Kadınların demografik verileri, beslenme bilgi düzeyleri ve alışkanlıkları ile ilgili veriler yüz yüze anket yöntemiyle alınmış olup; hedonik açlık düzeyleri 'Besin Gücü Ölçeği (BGÖ)' ve Akdeniz diyetine uyum düzeyleri ise 'Akdeniz Diyetine Bağlılık Ölçeği (MEDAS)' kullanılarak değerlendirilmiştir. Verilerinin analizi SPSS 23.0 programıyla yapılmıştır. Verilerinin analizi sonucunda kadınların toplamda %61,6'sının 18-34 yaş arası, %22,6'sının 35-49 yaş arası ve %15,7'sinin de 50-65 yaş arasında olduğu belirlenmiştir. Kadınların çoğunun yüksek okul mezunu olduğu, bu oranı lise mezunu olanların takip ettiği saptanmıştır. Kadınlardan %43,8'inin BKI ( $\text{kg}/\text{m}^2$ ) değerlerinin 25 ve üzerinde olduğu, %35,5'inin hızlı-hazır besin tükettiği, %42,0'sinin öğün atladığı, %37,5'inin kahvaltı yapmadığı belirlenmiştir. Araştırma bulgularına göre, katılımcıların toplamının %73,0'ünde hedonik açlık olduğu ve %45,0'inin Akdeniz diyetine diğerlerinden daha düşük skorda uyum gösterdiği belirlenmiştir. Çalışan ve çalışmayan kadınların eğitim düzeyleri, hızlı-hazır besin tüketme ve öğün atlama alışkanlıkları ile alkol tüketme oranları, hedonik açlık düzeyleri ve Akdeniz diyetine uyum skorları benzerlik gösterirken, çalışmayan kadınlarda BKİ değerleri ile kahvaltı yapma alışkanlıkları çalışan kadınlara kıyasla anlamlı derecede yüksek bulunmuştur ( $P<0,05$ ). Hedonik açlığı yüksek düzeyde olan kadınlarda Akdeniz diyetine uyum skorlarının daha düşük olduğu ( $P<0,05$ ) tespit edilmiştir. Hedonik açlığı olmayan kadınlarda ortalama Akdeniz diyeti uyum skoru 9,1 iken, hedonik açlığı olan kadınlarda bu skor 5,5 olarak bulunmuştur. Hedonik açlığı olan kadınlar ile olmayan kadınlar arasında; BKI ( $\text{kg}/\text{m}^2$ ) değeri ortalamaları ( $23,7 \text{ kg}/\text{m}^2$ ;  $23,4 \text{ kg}/\text{m}^2$ ), eğitim düzeyleri, kahvaltı yapma alışkanlıkları ve alkol tüketme alışkanlıkları arasında benzerlik



( $P > 0,05$ ) bulunurken; hedonik açlığı olan kadınların sigara içme (%85.0) ve hızlı-hazır besin tüketme alışkanlığı (%88,7) oranının, hedonik açlığı olmayan kadınlara kıyasla daha yüksek ( $P < 0,05$ ) olduğu saptanmıştır. Ayrıca Akdeniz diyetine uyum skorları düşük kadınların (%45) Akdeniz diyetine uyum skoru yüksek kadınlara (%21) kıyasla daha fazla öğün atladıkları ve hızlı-hazır besin tüketme alışkanlıklarının daha fazla olduğu görülmüştür ( $P < 0,05$ ).

**Anahtar Kelimeler:** Çalışan ve çalışmayan kadınlar, Hedonik açlık, Akdeniz Diyeti

## ABSTRACT

This study included working and non-working women between the ages of 18-65; The presence of hedonic hunger and the level of compliance with the Mediterranean diet; It was planned to examine the relationship between Body Mass Index (BMI) ( $\text{kg}/\text{m}^2$ ), smoking, alcohol consumption, fast-food consumption and skipping meals. 200 women participated in the study. In the selection of participants, care was taken to ensure that the number of working and non-working women was equal and/or close. Data regarding women's demographic data, nutritional knowledge levels and habits were obtained by face-to-face survey method; Hedonic hunger levels were evaluated using the 'Nutritional Power Scale (NPS)' and compliance levels with the Mediterranean diet were evaluated using the 'Mediterranean Diet Adherence Scale (MEDAS)'. Data analysis was done with SPSS 23.0 program. As a result of the analysis of the data, it was determined that a total of 61.6% of the women were between the ages of 18-34, 22.6% were between the ages of 35-49 and 15.7% were between the ages of 50-65. It was determined that most women were college graduates, followed by those who graduated from high school. 43.8% of the women had a BMI ( $\text{kg}/\text{m}^2$ ) value of 25 and above, 35.5% consumed fast-food, 42.0% skipped meals, 37.5% did not have breakfast. According to the research findings, it was determined that 73.0% of the total participants had hedonic hunger and 45.0% of them adapted to the Mediterranean diet at a lower score than others. While the education levels, fast-food consumption and meal skipping habits, alcohol consumption rates, hedonic hunger levels and Mediterranean diet compliance scores of working and non-working women were similar, BMI values and breakfast eating habits were found to be significantly higher in non-working women ( $P < 0.05$ ) compared to working women. It was determined that the compliance scores to the Mediterranean diet were low ( $P < 0.05$ ) in women with a high level of hedonic hunger in general. While the average Mediterranean diet compliance score was 9.1 in women without hedonic hunger, this score was 5.5 in women with hedonic hunger. Between women with hedonic hunger and women without; While there is a similarity ( $P > 0.05$ ) between BMI ( $\text{kg}/\text{m}^2$ ) values (23,7  $\text{kg}/\text{m}^2$ ; 23,4  $\text{kg}/\text{m}^2$ ), education levels, breakfast eating and alcohol consumption habits, women with hedonic hunger have a higher rate of smoking (85.0%) and fast-food consumption (88.7%) than women without hedonic hunger (It was determined that  $P < 0.05$ ). There was no difference ( $P > 0.05$ ) in the adaptation scores of women to the Mediterranean diet depending on



their education level, BMI (kg/m<sup>2</sup>) and breakfast habits; It was determined that women with low Mediterranean diet compliance scores (90 women) had more habits of skipping meals and consuming fast-ready foods, and consumed higher amounts of alcohol and cigarettes (P<0.05) compared to women with high Mediterranean diet compliance scores (42 women).

**Keywords:** Workin and non-working women, hedonic hunger, Mediterranean diet

## GİRİŞ

Beslenme, tüm canlılarda fizyolojik süreçlerin devamlılığını sağlayan en temel gereksinimdir. Sürekli gelişim ve değişim içerisinde olan insanın fizyolojik yapısında da bu değişim ve gelişimin etkileri zamanla görülmeye başlamıştır. Bu etkiler tüketim konusunda, beslenme davranışında zaman içerisinde büyük farklılıklar doğmasına neden olmuştur. İnsanların gelişimi ile fizyolojilerinde de yer eden bu değişimler zaman içerisinde ihtiyaçların ve ihtiyaçlara yönelik gelişmelerin de değişmesiyle sonuçlanmıştır. Günümüzde tüketim alanı, her türlü ihtiyacın hızlı ve kolay ulaşılabilir bir şekilde karşılandığı teknolojilerle donatılmıştır (Oran vd., 2017: s.1). Bu teknolojik ilerlemeler tarihsel süreçte geri planda olan kadınların zamanla çalışma hayatında da aktif rol almasına neden olmuştur (Bener ve Günay, 2011: s.157). Kadınlar toplumda genel olarak eş ve anne olarak düşünülmüş, çalışma hayatına girmeleri uzun bir zaman almıştır (Uşen ve Delen, 2011: s.127). Tarım gibi beslenme için önemli faaliyetlerde kadınlar yalnızca kendi aile işlerinde görev almış, ekonomik gelir elde etmek için çalışmanın gerekliliği kadınlar için ancak II. Dünya Savaşı'nın ardından kendini göstermiştir. Kadınların iş yaşamına girmesiyle hızlanan eğitim ve artan ekonomik gelişmeler aynı zamanda doğum oranlarının da azalmasına yol açmıştır (Korkmaz, 2016: s.301). Kadınların da katılımıyla hızlanan haberleşme, farklılıklara ulaşma ve global bilgi akışı içerisinde beslenmeye yönelik her türlü bilgi paylaşımı da büyük bir önemle yerini almıştır. Çalışma hayatında, sanal ortamda, sözlü iletişimde, evde ve sosyal ortamlarda, beslenmeye yönelik her türlü görsel, bilgi, tarifler ve kültürel etkinlikler insanları bir araya getiren temel taşı oluşturmakla kalmayıp, beslenme davranışının oluşmasında da büyük katkılar sağlamıştır (İşlek, 2012). Biyolojik bir ihtiyaç olmaktan çıkan beslenme davranışı, metabolizmanın tüm ihtiyacını karşılayabilecek nitelikte bir öğün sonrasında dahi haz veya ödül doyumunu hissedebilmek için farklı şekillerde oluşmaktadır (Yılmaz, 2019). Metabolizmanın ihtiyaç duyduğu besin öğeleri yeterliliği açısından Akdeniz diyeti ve Akdeniz tipi beslenme modelleri, bilim camiasında sağlıklı beslenme ve fizyolojik yeterlilik için birçok önemli faktörü barındıran, genel kabul görmüş bir beslenme modelidir (Trichopoulou, 2004: s.943). Ancak günümüzde insanların sıklıkla maruz kaldıkları ortamlarda besinler; yoğun enerji içeriğine sahip, tat duyusunun hazzına hizmet eden, görsel olarak cezbedici ve toplumda çekici hale getirilmiş bir yapıya sahiptir (Spence vd., 2016: s.53). Sanal ortamda, sosyal platformlarda ve televizyonda sıklıkla sunulan besin görselleri, besinlerin çıkardığı sesler veya yerken çıkarılan sesler, popüler kişiler tarafından tüketilen besinler, ya da besinin popüler oluşu tüketim oranını artıran ve kolaylaştıran unsurlar arasında



yer almıştır (Lau vd., 2017: s.38). Bireylerin fizyolojik olarak açlık hissetmediği durumlarda besinlere olan yönelimleri ve çevresel uyaranlardan etkilenmeleri besinlere ve her türlü beslenme davranışına karşı bir hassasiyet oluşturmuştur (Alvarenga vd., 2010: s.379).

### **1. Çalışan ve Çalışmayan Kadınlarda Yaşam Şekli ve Beslenme Alışkanlıkları**

Geleneksel olarak toplumlarda görülen cinsiyet rolleri arasında aile bireylerinin beslenmesinden sorumlu kişiler ailedeki kadın bireylerdir. Çalışan ve çalışmayan kadınlar çoğu toplumlarda ailenin beslenmesiyle birlikte ekonomik yapıya uygun bir mutfak profilinden de sorumlu tutulmaktadır (Güler, 2002). Yakın tarihlerden bu yana çalışma hayatına aktif ve yoğun bir şekilde katılan kadınlar; yaş, eğitim düzeyi, annelik ve/veya gebelik sürecindeki hassasiyetler gibi etkenlerden dolayı iş yaşamının gerisinde bırakılmışlardır (Cebula ve Coombs, 2008: s.272). Kadınların ev dışı işlerde çalışarak aile gelirine katkıda bulunması birçok toplumda yerini almış, ev içi sorumlulukları konusunda kadınların görevi sayılacak işlerden de beklentiler aynı oranda devam etmiştir. Ancak toplumlarda kadına yüklenen en önemli görev anneliktir. Fizyolojik olarak kadın bedeninde büyüyen bebek, beslenmesinin de ilk sürecini anneye bağımlı halde geçirir. Bu durum toplumların kadından beklentisinin ilk olarak çocuk yetiştirmek olarak görülmesine sebebiyet vermektedir. Ancak evli veya çocuklu olmasına bakılmaksızın birçok kadın ve kız çocuğu yaşadığı evin düzeni konusunda sorumlu tutulmaktadır (Uşen ve Delen, 2011: s.127). Günümüze değin modernleşme sürecinde kadınların iş hayatına katılmasıyla birlikte erkeklerin de üstlendiği ev işleri, cinsiyetle bağdaştırılan birçok tabunun yıkılmasını sağlamıştır (Bener ve Günay, 2011: s.157). Bu kırılma ilk olarak 1915 Balkan Savaşı'nda erkek nüfusun savaşa katılması ile başlamış, I. ve II. Dünya Savaşları sonrası kadınların üretimdeki yerini artırmasıyla büyümüştür. 1923 yılında Mustafa Kemal'in (Atatürk) kurduğu Türkiye Cumhuriyeti ile kadınlara birçok hak verilmiş, yapılan reformlar ile Türk kadını tarımsal yaşamdan kentsel işgücüne katılmaya başlamıştır (Korkmaz, 2016: s.301). Savaşlar ve ekonomik sıkıntılardan sonra erkek işgücünün ve makineleşmenin artmasıyla tekrar azalan kadın işgücü oranı, eğitimin artmasıyla günümüzdeki halini almıştır (Palaz ve Çolak, 2008: S.99).

### **2. Homeostatik Açlık ve Tokluk Mekanizması**

Yetişkin ve sağlıklı bir bireyin günlük enerji harcamalarının ortalama 1500 kcal'lık kısmı (%60-75'i kadarı) bazal metabolizma için kullanılır. Enerji ihtiyacını yalnızca glikozdan (ileri düzey açlıklarda keton cisimleri de dahil) karşılayan beyin, sinir dokuları, eritrositler, lökositler ve renal medulla gibi hayati hücreler için kan glikoz düzeyinin 70-110 mg/dL aralığında olması özellikle 100-160 kcal/gün glikozdan enerji sağlayan merkezi sinir sistemi (MSS) için elzemdir (Ganong, 1989: s.233; Bray, 1985: s.946; Burakgazi vd., 2013, s.1).

Açlık ve tokluk durumu her insanda farklıdır. Fizyolojik olarak aynı hormonal yanıtlar, aynı enzimler ve aynı sinir sistemi sinyalleri görev olsa da açlık ve tokluk hissinde kişilerin genetik



yapıları, büyüme şekilleri, beslenme alışkanlıkları, fiziksel aktivite kapasiteleri, tükettikleri besinlerin içeriği ve ırk yapıları son derece büyük farklılıklar oluşturabilmektedir (Hussain ve Bloom, 2013: s.625).

İnsanlarda temel olarak enerjiyi sağlayabilmek ve metabolizmanın açlık ve tokluk gibi fizyolojik tüm işleyişini takip edebilmesi için besin alımına ve açlık sinyaline ihtiyacı vardır. Beyin-bağırsak aksı, açlıkta sindirim sistemi ve enerji depolarından gelen yanıtları, besinlerin oluşturduğu enzimatik yanıtları ve gastrointestinal sistemde besinlerin ilerleme sürecinde gelişen kısa vadeli tokluk yanıtlarını ileten özel bir devredir (Capeleri vd., 2009: s.913). Açlık sinyalleri, enerji homeostazı için besin alımını başlatan uyarılar oluşturur. Enerji ihtiyacını karşılayacak, yeterli besin alımına teşvik ederek gereken enerji açığının kapatılmasını sağlar. Besin tüketimi ile salınan periferik tokluk sinyalleri, açlık mediyatörlerini baskılayarak vücut ağırlığı denetiminde de rol almış olurlar (Çamlık, 2020).

### 3. Hedonik Açlık Mekanizması

Açlık, besin arayışını motive eden faktörlerin davranışa dönüşmesini ve beslenme eyleminin başlamasını sağlayan komplike bir süreçtir (Montalto vd., 2008: s.104; Lowe ve Butryn, 2007: s.432). Hedonik yeme şekli birçok hormonla ilişkilidir. Hipotalamik enerji düzenleyici bir sinyal olan ve besin alımının ardından serbest bırakılan insülin hormonu, MSS içinde dopaminerjik sinyalleşmenin doğrudan değişmesini sağlayarak, besin alımının ödül sistemindeki etkisini azaltır (Stouffer vd., 2015: s.8543). İnsülin, beslenme davranışı ile seçilen lezzetli besinlerin alımını azaltır. İnsülin ödül merkezindeki dopamin salınımını artırarak besine olan isteği baskılar (Nigro vd., 2015: s.1351). Yalnızca mezolimbik dopamin sisteminin aracılığıyla oluşan lezzet algısının bir ödüle dönüşmesi bu sistemin zeminini oluşturur (Coccarello ve Maccarrone, 2018: s.271). Enerji homeostazını düzenleyen hipotalamik sistemlerden de öncelikli olan ödül sistemi ve hedonik sistem; lezzetli bulunan besinlerden özellikle yüksek enerjili, yüksek şekerli ve yağlı besinlerin çeşitliliği ile yüksek düzeyde uyarılarak belirginleşir (Cappelleri vd., 2009: s.913). Ödül sistemi ile metabolizmanın düzenlendiği mekanizmalar, kortikolimbik merkezde birleştirilir. MSS içinde aşırı yeme davranışının ödülle ilişkili gelişiminde endokannabinoidler ve opioid reseptörler rol alır (Kelly vd., 2003: s.2592). Besin ödülü ve madde bağımlılığına bağlı madde kullanımının-bulunduğu nöral devre, opioid sistemi oluşturur. Tıpkı madde kullanımında olduğu gibi, hızlı tüketilen besinler de endojen opioidlerin salınımını uyararak haz duygusunun oluşmasını sağlar. Sık tüketilen lezzetli besinler, post-sinaptik opioid reseptörleri, arka arkaya ve çok kez uyardığında, reseptör sisteminde veya işlevselliğinde değişiklikler meydana gelir (Loxton ve Tipman, 2017: s.28). Ödül duyarlılığı fazla olan bireylerde, özellikle yüksek yağ ve şeker içeren besinlere daha fazla ödüllendirici özellik atadığı görülmüş, bu tür besinlerin fizyolojik sorunlara sebep olması ile süreklilik kazanan aşırı beslenme davranışı, yüksek besin duyarlılığı ile bağlantılı hale gelmiştir. Genetik ve fMRI (fonksiyonel manyetik rezonans görüntüleme), çalışmalar

göstermiştir ki; orta beynin ödül algısı olan durumlara yanıtı farklıdır (Lee ve Dixon, 2017: s.353). Beslenme davranışında öğrenme ve hafızanın besine dayalı deneyimler ile oluşturduğu kodlamalar; tüm duyuşal işlevler için geniş alanlara ayrılabilen beynin bölümleri içerisinde öncelikle duyuşal entegrasyonun girdiği orbitofrontal bölge olmak üzere, profrontal ve insular korteks gibi polimodal entegrasyon bölgelerinde tat duyusunun işlenmesiyle sağlanır (Stice, 2010: s.1618). İnternal konularda ve tat alma duyusunda görevli insular korteks, vagus siniri aracılığıyla beslenmeye etki eder. Ayrıca insular korteks bilinçten ve bilinçli olmaktan sorumlu nöronal bölgedir (Yokum vd., 2011: s.1775). AgRP/NPY nöronları, beyindeki bilinci sağlayan bölgede lezzetli besinlere karşı gösterilen kontrolü azaltır. Besinlerin oluşturduğu bireysel ödül değerinin artmasını sağlayacak bir yansıma uyarısı gösterir (Sun vd., 2015: s.7964). Homeostatik besin alımının regülasyonu ile ödül sistemini içine alan bilişsel düzenleme merkezinde, besine yönelimi artıran AgRP/NPY nöronları, POMC/CART nöronlarının aktivasyonu ile baskılanır. Çünkü POMC/CART nöronları besin alımını durduran uyarılar oluşturur (Stice vd., 2015: s.10136). Beslenme davranışı öncesinde, beslenme sırasında ve sonrasında beslenme ile ilgili internal ve eksternal bilgilerin MSS'ne geçişi Şekil 4.'de gösterilmiştir.

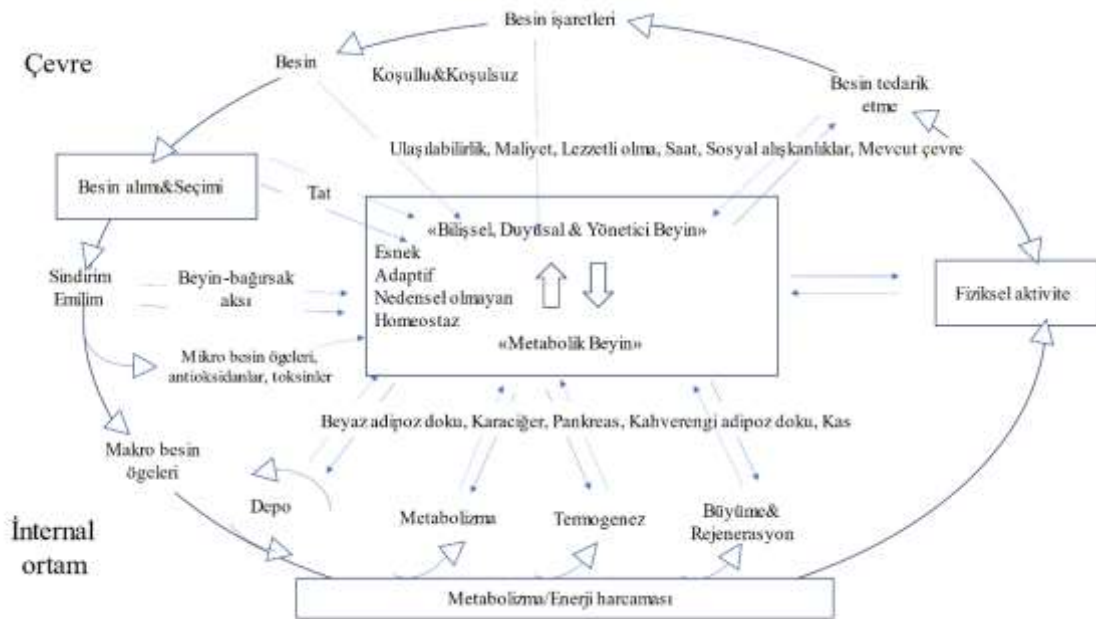

Şekil 4. Beslenme davranışı öncesinde, beslenme sırasında ve sonrasında hem içerden hem dışardan gelen beslenme ile ilgili bilgilerin MSS'ne geçişi (Tayfur, 2021: s.1).

#### 4. Hedonik açlık ve ilişkili hastalıklar

##### *Hedonik açlık ve obezite*

Açlık sınırındaki gelişmemiş ve gelişmekte olan ülkeler hariç gelişmiş ve gelişmekte olan birçok ülkenin önde gelen sağlık problemleri arasında obezite yer alır (Hruby vd., 2016: s.1656). Çevresel etki alanı güçlü, önlenemeyen hastalıklar için ana sebep kabul edilebilen obezite genetik olarak da aktarılabilen çok yönlü bir sağlık sorunudur (Cheung vd., 2018:).



Obezite, homeostatik besin alımında kontrol edilen sinyallerden besin alımının durdurulması için gerekli motivasyonel sinyali engelleyen ya da yok sayan bozukluklar oluşturur. Lezzetin ödül olarak kabul edildiği ve besine yönelik bir tüketim isteği oluşturan hedonik açlık, mezolimbik sistemde dopamin salgılanmasıyla açığa çıkar. Bu durum obezite için artırıcı bir faktördür (Lowe ve Butryn, 2007: s.432). Açlık durumunda gelişen besin isteğinin güçlü olması ve yeme davranışı için kontrolün azalması obez yetişkinlerde kendilerine olan güveni azaltan bir durumdur. Özellikle hedonik açlığı yüksek bireylerde görülen bu durum hedonik açlık ile fizyolojik açlık arasındaki etkileşimi belirginleştiren bu çalışma ile ortaya konmuştur (Ribeiro vd., 2018: s.5857).

### ***Hedonik açlık ve tip 2 diyabet***

Metabolizmanın açlık hissi dışında besine yönelik cevapları sürekli hale geldiğinde oluşan hormonal yanıt, bozukluklarının ilerlemesi kaçınılmazdır. Bu gibi yanıtların sonucunda artabilen hastalıklardan olan tip 2 diyabet gibi metabolik bozukluklar ile iyileştirilmeye çalışılan beslenme davranışları ve fiziksel aktivite düzeyleri yetersiz kalabilmektedir (O'Neil vd., 2012: s.354). Hedonik açlık ile fizyolojik glisemik yanıtlar arasındaki bağlantı sonucu gelişen aşırı besin alımı davranışının belirlenmesi, tip 2 diyabetli hastalar için çok önemlidir. Biyolojik olarak metabolizmanın açlık oluşturmadığı ve enerji ihtiyacı duymadığı durumlarda gelişen lezzetli besin tüketme arzusu ve aşırı besin tüketimi tip 2 diyabetli bireylerin besin alımı fizyolojisindeki olumsuzluğun bir göstergesidir. Glisemik kontrol ile hedonik açlık arasındaki ilişkinin incelenmesi amaçlanan bir çalışmada; obez olan ve olmayan tip 2 diyabetli bireylerden, obez tip 2 diyabetli bireylerin hedonik açlık skorlarının daha yüksek olduğu, hedonik açlık skoru düşük obez tip 2 diyabetli bireylerin glisemik kontrollerinin daha iyi olduğu, obez olmayan tip 2 diyabetli bireylerde hedonik açlık ile glisemik kontrol arasında böyle bir ilişki bulunmadığı sonucuna varılmıştır (Şarahman, 2019: s.14). Açlığın ve tokluğun fizyolojik yanıtlarının besin alımı üzerindeki kontrolünü belirlemek için bilişsel davranışçı stratejilerin obez ve tip 2 diyabetli bireylerdeki etkisinin açığa çıkarılması hedonik açlık için de gereklidir (Ulaş vd., 2013: s.15).

### ***Hedonik açlık ve yeme bozuklukları***

Dünya Sağlık Örgütü (DSÖ) tarafından “önemli tıbbi durum” olarak belirtilen ve yaygınlığı artan yeme bozuklukları özellikle genç yaş grubu bireylerde sık görülen bir durumdur. Yeme alışkanlıklarındaki sapmalara neden olabilen depresyon, anksiyete, madde bağımlılığı gibi sağlık problemleri ile aşırı beslenme ya da besin yetersizliği yeme bozuklukları olarak tanımlanabilir (Witt, 2014: s.273). Yeme bozukluğu olan bireylerin homeostatik açlık ile hedonik açlık durumları arasındaki farkı gözetmek güçtür. Çoğunlukla normal vücut ağırlığına sahip bulimia nervosa bireyler kısıtlayıcı beslenme davranışı sergiledikleri için hedonik besin tüketimleri oldukça sık ve ataklar halinde görülür. Özellikle besin tüketiminden sonra duyuşsal





olarak doygunlarının azalması ve mutluluk hissi kaybı bulumia nervosalı bireylerin hedonik iştahlarının hassas ve kolay etkilenebilir olduğu düşünülmektedir. Vücut ağırlığı yönünden düşük BKİ'ye sahip olsalar da enerji yoksunluğu ve yüksek kısıtlayıcı beslenme tutumu anoreksiya nervosalı bireylerin hedonik açlık puanlarının da yüksek olmasına neden olabilmektedir. Kontrol kaybı nedeniyle aşırı besin tüketimi sonucu duygusal zayıflık hisseden birçok birey yeme bozukluğu belirtileri göstermektedir (Davis ve Carter, 2009: s.1). Tıkanırcasına yeme bozukluğu gibi durumlarda görülen besin alımına yönelik artmış motivasyon obezite ile bağlantılı hedonik besin isteği ile benzerdir (Ernst vd., 2009: s.274). Tıkanırcasına yeme bozukluğunda görülen besin alımı sırasındaki kontrol kaybı, obez ve normal vücut ağırlığına sahip bireylerde skorlanan hedonik açlık puanlarıyla doğru orantılıdır. Tıkanırcasına beslenme davranışı sonucu gelişecek vücut ağırlığı artışı; obezite ve hedonik açlık arasındaki bağlantıyı güçlendirmektedir (Davinelli vd., 2018: s.1). Hedonik açlık seviyeleri arasındaki farkın belirlenmesi amacıyla yapılan çalışmalarda tıkanırcasına yeme bozukluğu olan obez ve normal vücut ağırlığındaki bireylerde; obezlerin hedonik açlık skorlarının yüksek olduğu belirlenmiştir (Ernst vd., 2009: s.274).

##### **5. Akdeniz diyeti tanımı ve kapsamı**

İlk kez bilimsel olarak Acel Keys ve arkadaşlarının Akdeniz havzasındaki toplumların beslenme alışkanlıklarını araştırması ve 'The Seven Country Study' adlı çalışmayla 1960'lı yıllarda tanımlanmıştır (Selimoğlu ve Gültekin, 2018: s.71; Ersoy ve Özdemir, 2010: s.75; Naska ve Trichopolou, 2014: s.216; Nestle, 1995: s.1313). Bu çalışmadan daha önce II. Dünya Savaşı'nın ardından ekonomik ve sosyal durumların yansımaları nedeniyle iyileştirilmesi gereken toplum sağlığının, 1948-53 yılları arasında Girit Adası'nda gerçekleştirilen 'The Rockefeller Foundation's Study' adlı çalışma Akdeniz diyetinin temelini oluşturan çalışmalardan biridir. Ancel Keys'in 'The Seven Country Study' çalışması ile koroner kalp hastalığının prevalansı ve risk faktörleri araştırılırken, 'The Study by EURATOM' çalışması Akdeniz bölgesindeki toplumların beslenme alışkanlıklarının hastalıklar üzerindeki epidemiyolojisi karşılaştırılmak istenmiştir (Kromhout vd., 1989: s.889). Bu çalışmalar ile temelleri araştırılan Akdeniz beslenmesi; yaşayan, değişen, gelişen ve bin yıllık tarihi birikimi ile canlılığını kaybetmeyen bir diyet türüdür. Tanımı henüz çok eski olmasa da kuşaklar boyunca toplumların yaşadığı tüm tarihi süreçlerden etkilenecek, bölgedeki her ülkenin farklı yönleri ile çeşitlenmiş, homojen olmayan, dini ve kültürel ayrılıklar ile zengin ürün çeşitlerinin renklerini yansıtır (Tricholopou ve Lagiou, 1997: s.383).

##### **6. Akdeniz diyetinin kökeni ve tarihçesi**

Antik çağlarda tüketilen besinlere yönelik ipuçlarının olduğu Homeros'un yazıtlarında; ekmek ve bitkisel besin gruplarının genelde tüketilen yaygın besinler olduğu, et ve deniz ürünleri gibi besinlerin daha çok özel günlerde hazırlandığı, nadiren sebze-meyvelerden bahsedildiği



görülmüştür. Arkeolojik kazılar ile elde edilen bulgular Akdeniz diyet tarihinin; resimlere, şiirlere ve araç-gereçlere yansıyan önemli sanatsal bir kökü olduğunu gün yüzüne çıkarmıştır (Kromhout vd., 1989: s.889). Çok fazla medeniyete kucak açmış ve birçok kültürü besleyerek büyütmüş Akdeniz havzası, binlerce yıllık birikimleri ile günümüz Akdeniz kültürlerini açığa çıkarmıştır. Önceleri her biyolojik türün yetişmediği bu bölge, zaman içerisinde medeniyetlerle gelen birçok bitkinin vatanı haline gelmiştir. Domates, patates, pirinç, fasulye, patlıcan, mısır gibi besinler ile birlikte, Amerika'dan gelen dikenli bitkiler, Araplar ile getirilen portakal ve limon Akdeniz bölgesindeki topraklarda yetişme alanı bulmuşlardır. Aslında bölge yapısı itibari ile zeytin, üzüm ve buğdayın en önemli yetişme alanıdır. Akdeniz diyetinin de zeminini oluşturan temel unsurlardan zeytin ve zeytinyağı, bölgedeki farklılıklar içinde öne çıkan en belirgin ortak noktadır. Dünyadaki birçok bölgeye nazaran TDYA'lerinin tüketiminin doymuş yağ asitlerine göre yüksek olması, bölgedeki ülkelerin ana beslenme prensiplerindedir. Total yağ tüketimi doymamış yağ asitlerinden gelse de tüketim oranlarında günlük enerjinin yağdan gelen yüzdelik kısmı farklılık gösterebilir. Günlük olarak, İtalyanlar enerjinin %30'u kadarını yağdan alırken, Yunanlarda bu oran %40'a çıkmıştır (Willet vd., 1995: s.1402).

### **7. Akdeniz diyetinin sağlık üzerine etkileri**

Akdeniz beslenme modelinde biyolojik çeşitlilik, çeşitliliğe katkı sunan çok mevsimlilik ve mevsimsel ürünlerin yoğunluğu ile gelenekselleşmiş besin ürünlerinin yerel bir kullanım şekli oluşturması önemli katkılar sunmuştur (Gönder ve Akbulut, 2017: s.110). 1993 yılında Oldway'in tasarladığı ve 2009 yılında güncellenen Akdeniz Diyeti Piramidi'nde bu besin gruplarının önerilen porsiyon miktarları sembolize edilmiştir. Piramidin en alt tabanında ve en büyük alana sahip bölümde en fazla ve sürekli tüketilmesi gereken besinler yer alırken; piramidin tepesine doğru azalan matematiksel alan hacmi ile tüketimi ve sıklığı azaltılması gereken besinler, diyetin genel prensipleri için bir kılavuz olmuştur (Serra-Majem vd., 2004: s.931).

### **8. Akdeniz diyetinin hastalıklarla ilişkisi**

Besin çeşitliliğinin zenginliği ile besin öğeleri açısından çok fazla çeşitlilik sağlayan Akdeniz diyetinin sağlık üzerindeki pozitif etkileri ve hastalıklara karşı koruyucu görevleri ideal bir beslenme modeli olarak önerilmesini sağlar. Metabolik sendrom, tip 2 diyabet, kardiyovasküler hastalıklar, kanser türleri, nörodejeneratif hastalıklar ve osteoartrit gibi çeşitli hastalık risklerini azalttığı görülen Akdeniz beslenmesinin sayısız çalışması mevcuttur (Tzima vd., 2007: s.22). Koroner kalp hastalıkları ve periferik arter hastalıklarının gelişmesinde önleyici etkileri bulunan sebze tüketimi, zeytinyağı tüketimi ve balık tüketimi ayrıca, HDL kolesterolü yükseltici etkiler ve göğüs kanserine karşı koruyucu etkiler gösterirler. Bazı kanser türlerinin gelişme riskini azaltan sebze-meyve tüketimi epidemiyolojik çalışmalarda gösterilmiştir. Metabolik hastalıkların çoğunun gelişmesinde ilişkili görülen hiperglisemik yanıtların azalmasını



sağlayan besinler; zeytinyağı, tam tahıllar ve kompleks karbonhidratlardır (Willett vd., 1995: s.1402).

## SONUÇLAR

Araştırmada, çalışan ve çalışmayan kadınların hedonik açlık düzeyleri ile Akdeniz diyetine bağlılıkları arasındaki ilişki incelenmiştir. Elde edilen sonuçlar ve öneriler özetlenmektedir.

Çalışan ve çalışmayan kadınlar ile yapılan, hedonik açlık ve Akdeniz diyetine uyum arasındaki ilişkinin incelendiği ilk çalışmadır. Araştırmaya 200 kadın katılmış olup, kadınların yaş ortalaması  $35,90 \pm 13,19$ 'dur. Katılımcıların %50.00'si çalışan, %50.00'si çalışmayan kadınlardan oluşmuştur. Kadınların %60,50'si evli, %39,50'si bekadır. Kadınların %1.00'i ilkökul mezunu, %1,50'si okur-yazar, %6,50'si ortaokul, %9.00'u lisansüstü, %22,50'si lise ve %59,50'si yüksekokul mezunudur.

Kadınların %73'ünün BGÖ sonuçlarına göre 2,5 ve üzeri puanla hedonik açlığı vardır. Kadınların %27'si BGÖ'den 2,5 puandan daha düşük skor almıştır ve hedonik açlığı yoktur.

Çalışan kadınların hedonik açlık düzeyleri çalışmayanlardan az değildir. Çalışan ( $3,32 \pm 1,04$ ) ve çalışmayan ( $3,39 \pm 1,05$ ) kadınların BGÖ skorları arasında benzerlik vardır ( $p > 0,05$ ). Bu sonuç çalışan kadınların hedonik açlık düzeyleri çalışmayan kadınlardan daha düşüktür hipotezi ile ters düşmüştür. Çalışan ( $3,61 \pm 0,91$ ) ve çalışmayan ( $3,73 \pm 0,87$ ) kadınlarda, BGÖ faktörlerine göre ne yüksek ortalama puanı her iki grupta da faktör 3 (besinin tadına bakılması) alırken, en düşük puan ortalaması faktör 1 (besin bulunabilirliği)'dir. Bu sonuç çalışan kadınların hedonik açlık düzeylerinin çalışmayan kadınlardan daha az olması gerektiğini savunan hipotezi çürütmüştür.

Çalışan kadınların BKİ değeri ortalamaları ( $23,00 \pm 4,31$ ), çalışmayan kadınların BKİ değeri ortalamalarından ( $24,38 \pm 4,82$ ) düşük bulunmuştur. Bu sonuç çalışan kadınların BKİ değerlerinin çalışmayanlardan daha düşüktür hipotezini doğrulamıştır.

Çalışan ( $6,28 \pm 2,62$ ) ve çalışmayan ( $6,73 \pm 2,71$ ) kadınların MEDAS skor ortalamaları benzer bulunmuştur ( $p > 0,05$ ). Bu sonuç çalışan kadınların Akdeniz diyetine uyum düzeyleri çalışmayan kadınlardan daha yüksektir hipotezi ile ters düşmüştür.

Hedonik açlığı olan kadınların MEDAS skoru ortalamaları ( $5,54 \pm 1,91$ ), hedonik açlığı olmayan kadınların skor ortalamalarından ( $9,09 \pm 3,73$ ) düşük bulunmuştur. Bu sonuca göre hedonik açlığı olan kadınların Akdeniz diyetine uyum düzeyi daha düşüktür hipotezi doğrulanmıştır.

Hedonik açlığı olan ( $23,79 \pm 4,58$ ) ve olmayan ( $23,40 \pm 4,72$ ) kadınların BKİ ( $\text{kg}/\text{m}^2$ ) değerleri arasında benzerlik vardır. Bu sonuca göre hedonik açlığı olan kadınların BKİ ( $\text{kg}/\text{m}^2$ ) değerleri daha yüksektir hipotezini doğrulamamıştır.



## KAYNAKÇA

- Alvarenga, M. D., S. Scagliusi, F. B. & Philippi, S. T. (2010). Development and Validity of the Disordered Eating Attitude Scale (DEAS). *Perceptual and motor skills*. 110(2), 379-395.
- Bener Ö, Günay G. (2011). Kadınların toplumsal cinsiyet rolleri çerçevesinde aile içi yaşamı algılama biçimleri. *Türkiye Sosyal Araştırmalar Dergisi* 15(3), 157- 171.
- Bray G. A. (1985). In Sodeman's Pathologic Physiology, 7th edn., pp.964-992, W.B. Saunders Company, Philadelphia.
- Burakgazi, G., Öztürk, T., Akyol M., & Yıldırım, H. (2013). Obez Çocuklarda Beynin Difüzyon Ağırlıklı Manyetik Rezonans Görüntüleme Bulguları. *Mustafa Kemal Üniversitesi Tıp Dergisi*, 4 (14), 1-8.
- Cappelleri, J. C., Bushmakin, A. G., Gerber, R. A. et al. (2009). Evaluating the Power of Food Scale in obese subjects and a general sample of individuals: development and measurement properties. *International Journal of Obesity*. 33, 913–922.
- Cebula R. J., Coombs C. K. (2008). Recent evidence on factors influencing the female labor force participation rate. *J Labor Res*. 29, 272–284.
- Cheung, L. T., Ko, G. T. C., Chow, F. C. C. et al. (2018). Association between hedonic hunger and glycemic control in non-obese and obese patients with type 2 diabetes. *Journal of Diabetes Investigation*. 9(5), 1135-1143.
- Coccorello, R., Maccarrone, M. (2018). Hedonic eating and the “delicious circle”: from lipid-derived mediators to brain dopamine and back. *Frontiers in Neuroscence*. 12, 271.
- Çamlık, Z. (2020). *İnsülin Direnci Olan Yetişkin Bireylerin Hedonik Açlık Durumlarının Farklı Ölçeklerle Belirlenmesi*. Sağlık Bilimleri Enstitüsü, Başkent Üniversitesi, (Yayınlanmamış Yüksek Lisans Tezi).
- Davinelli, S., Trichopoulou, A., Corbi, G., De, Vivo, I., (2018). Scapagnini G. The potential nutrigenoprotective role of Mediterranean diet and its functional components on telomere length dynamics. *Ageing Research Reviews*. 49, 1-10.
- Davis, C., Carter, J. C. (2009). Compulsive overeating as an addiction disorder. A review of theory and evidence. *Appetite*. 53, 1–8.
- Ernst, B., Thurnheer, M., Wilms, B. et al. (2009). Differential changes in dietary habits after gastric bypass versus gastric banding operations. *Obes Surg*. 19, 274–280.
- Ersoy G, Özdemir G. Akdeniz diyetinin sağlığa yararları. *Türkiye Klinikleri Cardiovascular Sciences* 2010;22(1):75-84.



- Ganong W. F. (1989). In Review of medical physiology, 14th edn., pp.233-265, *Appleton and Lange*, New Jersey.
- Gönder, M., Akbulut, G. (2017). Güncel Akdeniz diyeti ve potansiyel sağlık etkileri. *Türkiye Klinikleri J Health Sci.* 2(2),110-20.
- Güler, B. ve Özçelik A. Ö. (2002). *Çalışan ve çalışmayan kadınların yiyecek satın alma, hazırlama davranışları üzerinde bir araştırma*. Yüksek Lisans Tezi (basılmamış), Ankara Üniversitesi, Ankara.
- Gültekin, H., Şahin, S. (2005). Oreksinler (hipokretinler): obezite tedavisinde yeni hedef moleküller. *Genel Tıp Dergisi.* 15(2), 85-90.
- Hruby, A., Manson, J. E., Malik, V. S. et al. (2016). Determinants and consequences of obesity. *American Journal of Public Health.* 106, 1656–1662.
- Hussain, S.S., & Bloom, S.R. (2013). The Regulation of Food Intake by the Gut-Brain Axis: Implications for Obesity. *International Journal of Obesity.* 37(5), 625- 633.
- Kelly, A. E., Will, M. J., Steininger, T. L. et al. (2003). Restricted Daily consumption of a highly palatable food (chocolate Ensure) alters striatal enkephalin gene expression. *European Journal of Neuroscience.* 18, 2592-2598.
- Korkmaz Ö. (2016). Kadınların işgücüne katılma eğilimleri: Türkiye örneği. *TİSK Akademi* 301-329.
- Kromhout, D., Keys, A., Aravanis, C., Buzina, R., Fidanza, F., Giampaoli, S., et al. (1989). “Food Consumption Patterns in the 1960’s in seven countries.” *American Society for Clinical Nutrition.* 49(5), 889-893.
- Lau, B. K., Cota, D. Cristino. L. & Borgland, S. L. (2017). Endocannabinoid Modulation of Homeostatic and Non-Homeostatic Feeding Circuits. *Neuropharmacology.* 124, 38-51.
- Lee, P. C., Dixon, J. B. (2017). Food for thought: Reward mechanisms and hedonic overeating on obesity. *Curr Obes Rep.* 6, 353–361.
- Lowe, M. R., Butryn, M.L. (2007). Hedonic hunger: A new dimension of appetite? *Physiology & Behavior.* 91, 432–439.
- Loxton, N. J., Tipman, R. J. (2017). Reward sensitivity and food addiction in women, *Appetite,* 115, 28-35.
- Montalto, M., Santoro, L., D’Onofrio, F., et al. (2008). Classification of malabsorption syndromes. *Dig Dis* 26(2), 104-11. <https://doi.org/10.1159/000116767>
- Naska, A., Trichopolou, A. (2014). Back to the future: The Mediterranean diet paradigm. *Nutrition. Metabolism and Cardiovascular Diseases.* 24, 216-219.



- Nestle, M. (1995). Meditarrenean Diets: Historical and Research Review. *American Journal of Clinical Nutrition*. 61(1), 1313-1320.
- Nigro, M., Monteleone, A., Di Marzo, V., Dalle Grave, R., El Ghoch, M., Cimino, M. (2015). Neuroendocrine Responses to Hedonic Eating in Obese Patients with and Without Binge Eating. *European Psychiatry*. 30, 1351.
- Nyberg, M., Lennernas, M., Jahncke, H., Ljung, R. (2012). The staff restaurant as a meal arena: perceptions and attitudes about food and meal in the workplace. *The Journal of University Gavle*. 191.
- O'Neil, P. M., Theim, K. R., Boeka, A. et al. (2012). Changes in weight control behaviors and hedonic hunger during a 12 week commercial weight loss program. *Eating Behaviors*. 13, 354-360.
- Oran N.T., Toz H., & Küçük T. (2017). Medyanın Kadınların Beslenme Alışkanlıkları, Besin Seçimi ve Tüketimi Üzerindeki Etkileri. *Life Sciences*. 12(1), 1-13.
- Palaz S., Çolak O. (2008). Küresel finans krizi ve Türkiye'de kadınların işgücüne katılımı. *Balıkesir Üniversitesi Sosyal Bilimler Enstitüsü Dergisi*. 99-115.
- Ribeiro, G., Camacho, M., Santos, O. et al. (2018). Association between hedonic hunger and body-mass index versus obesity status. *Nature Scientific Reports*. 8, 5857.
- Selimoğlu, E. & Gültekin, T. (2018). Laura Esquivel 'in Acı Çikolata Romanı Üzerinden Duygusal Dünya ve Yemek Kültürü İlişkisi. *Antropoloji*. (36), 71- 85.
- Serra-Majem, L., Ribas, L., Ngo, J., Ortega, R. M., García, A., Pérez-Rodrigo, C., et al. (2004). Food, youth and the Mediterranean diet in Spain. Development of KIDMED, Mediterranean diet quality index in children and adolescents. *Public Health Nutrition*. 7(7), 931-935.
- Spence, C. Okajima, K. Cheok, A. D. et al. (2016). Eating with our eyes: From visual hunger to digital satiation. *Brain and Cognition*. 110, 53-63.
- Stice, E., Burger, K. S., Yokum, S. (2015). Reward Region Responsivity Predicts Future Weight Gain and Moderating Effects of the TaqIA Allele. *The Journal of Neuroscience*. 35(28),10316-10324.
- Stice, E., Yokum, S., Bohon, C. et al. (2010). Reward circuitry responsivity to food predicts future increases in body mass: moderating effects of DRD2 and DRD4. *NeuroImage*. 50, 1618-1625.
- Stothard, E. R. (2017). Impact of Circadian and Sleep Disruption on Metabolic Health and Behavior. *Current Diabetes Reports*. 14(7), 507.



- Stouffer, M. A., Woods, C. A., Patel, J. C., Lee, C. R., Witkovsky, P., Bao, L. (2015). Insulin enhances striatal dopamine release by activating cholinergic interneurons and thereby signals reward. *Nature Communications*. 6, 8543.
- Şarahman, C. (2019). *Yetişkin Bireylerin Hedonik Açlık Durumlarını Etkileyen Faktörlerin İncelenmesi*. (Yüksek lisans tezi). Başkent Üniversitesi, Sağlık Bilimleri Enstitüsü. Ankara. 14-15.
- Tayfur, M. (2021). Yemenin Nörobiyolojisi: Duygusal Yeme. *Beslenme ve Diyetetik Güncel Konular-10* (1. Baskı) içinde (s. 1-33). Hatiboğlu Yayıncılık.
- Trichopoulou A., Costacou T., Bamia C., Trichopoulos D. (2003). Adherence to a mediterranean diet and survival in a greek population. *The New England Journal of Medicine*. 348(26), 2599-2608.
- Trichopoulou, A. (2004). *Traditional Mediterranean Diet and longevity in the elderly: a review*. *Public Health Nutr*. 7(7), 943-947.
- Trichopoulou, A., Lagiou, P. (1997). Healthy traditional Mediterranean diet: An expression of culture, history, and lifestyle. *Nutr Rev*. 55(11 Pt1), 383-9.
- Tzima, N., Pitsavos, C., Panagiotakos, D. B., Skoumas, J., Zampelas, A., Chrysohoou, C., et al. (2007). Mediterranean diet and insulin sensitivity, lipid profile and blood pressure levels, in overweight and obese people; the Attica study. *Lipids Health Dis* 6, 22.
- Ulaş, B., Uncu, F., Üner, S. (2013). Sağlık Yüksekokulu öğrencilerinde olası yeme bozukluğu sıklığı ve etkileyen faktörler. *İnönü Üniversitesi Sağlık Bilimleri Dergisi*. 2, 15–22.
- Uşen Ş., Delen M. (2011). Eğitimli kadınların çalışma hayatına ilişkin tercihleri: İstanbul örneği. *Kamu-İş* 11(4), 127-182.
- Willett, W. C., Sacks, F., Trichopoulou, A., Drescher, G., Ferro-Luzzi, A., Helsing, E., et al. (1995). Mediterranean diet pyramid: A cultural model for healthy eating. *Am J Clin Nutr*. 61(6 Suppl), 1402-6.
- Witt, A. A., (2014). Hedonic hunger and binge eating among women with eating disorders. *Int J Eat Disord*, 47, 273–280.
- Yılmaz, C. S. (2019). *Yetişkin Profesyonel Erkek Futbolcuların Hedonik Açlık ve Beslenme Durumlarının Belirlenmesi*. Sağlık Bilimleri Enstitüsü, Başkent Üniversitesi (Yayınlanmamış Yüksek Lisans Tezi).
- Yokum, S., Ng, J., Stice, E. (2011). Attentional bias to food images associated with elevated weight and future weight gain: an fMRI study. *Obesity*, 19: 1775-1783.



## FOSTERING AN UNDERSTANDING OF E-WASTE MANAGEMENT AMONG STUDENTS IN MODERN EDUCATIONAL SYSTEMS

**Fr. Baiju Thomas**

**Research Scholar**

Ramakrishna Mission Vivekananda Educational and Research Institute,

Faculty of Disability Management and Special Education,

Vidyalaya Campus, SRKV Post, Coimbatore – 20

### ABSTRACT

The contemporary study fosters an understanding of E-Waste management among students in modern educational systems. Some of the most important environmental problems we face today are climate change and E-Waste, which endanger all life on Earth. When asked about E-Waste and government laws, most students had similar opinions. E-waste is a term that many students need to familiarize themselves with. Concern about the potential effects of E-Waste is becoming more prevalent in modern society. More and more proof of the environmental crisis occurring in emerging nations is appearing daily. Pollution due to E-Waste affects more than just human health. The destruction of ecosystems and entire communities may be achieved with only a small amount of pollution. E-waste includes old computers, air conditioners, mobile phones, home stereos, and electric appliances. Included in this category is an ever-expanding variety of electrical gadgets. Students' knowledge concerning E-Waste is the intended target of this initiative. Modern technology has experienced an enormous shift that may improve several areas while reducing expenses. The environment and human health are in grave danger from the disturbing increase in the use of electronic devices and electronic waste caused by technological progress. E-waste management contains hazardous substances that can cause various health problems. One way to reduce the build-up is to increase public education on E-Waste and the correct disposal methods for a lot of it. It will show students' understanding of how to dispose of E-Waste. Since this, they will have an easier time integrating and highlighting E-Waste topics into their next lesson plans and curriculum resources. Providing environmental education to students is a top priority in the country's school system. To reduce the build-up rate, educating the students about E-Waste management and how to handle a great deal of it properly is important. The study will reveal students' knowledge of E-Waste and its proper disposal and management. This will make it easy for them to integrate and highlight E-Waste management issues into their next curriculum. The traditional educational system strongly emphasizes teaching E-Waste management among students, while the modern educational system.

**Keywords:** Fostering, Understanding, E-Waste Management, Students, Modern and Educational Systems





## ADHESIVE WEAR INVESTIGATION OF GLASS FIBER MATERIALS

Assist. Prof. Dr. Mehmet Akif HAFIZOĞLU

Dicle University

ORCID NO: 0000-0002-9689-3004

### ABSTRACT

Compared to traditional materials such as steel and aluminum, composites offer several advantages. These include being lightweight, having high strength and stiffness, excellent vibration damping properties, design flexibility, corrosion and wear resistance. Glass fiber materials are an example of such composites. Glass fiber reinforced composites are increasingly preferred over traditional metallic components in many fields such as the automotive and marine industries due to their lower density, higher specific strength and durability. Wear properties are also an important factor to consider for these materials. Studies are underway to examine the tribological properties of these composite materials by subjecting them to various conditions such as rolling and sliding against other materials. This study shows the results of wear tests conducted to examine the wear properties of glass fiber materials. The material used in the study is commercially glass fiber rod material. Three different wear loads, three wear distances and two different speeds were used for wear tests. It has been determined that the most important parameters affecting the amount of wear are time and load.

**Keywords:** Glass fiber, Adhesive wear, Composite materials

### INTRODUCTION

Fiber reinforced polymeric composites are extensively utilized in the structural, aerospace, and automobile sectors owing to their high specific strength, lower costs, high wear resistance, high fatigue resistance, low density, non-corrosive and good machinability (Rajak et al., 2021). These materials offer an advantage over conventional materials due to these and many other characteristic properties. Various fibres have been studied extensively, including glass, carbon and Kevlar (Ohmae et al., 1974; Sathishkumar et al., 2014). Because of its exceptional elasticity, high corrosion resistance, low weight, high specific strength, high chemical resistance and high thermal stability, glass fiber reinforced polyester composite materials are widely employed in many different applications (Weiland et al., 2021). These composites have shown to be a dependable and affordable substitute for conventional materials (Jesthi and Nayak, 2019).

Wear is defined as the undesired material loss that causes tribological strains to develop on the solid's surface. The primary wear mechanism on any moving element, whether lubricated or not, is adhesive wear. To an object, when a normal force is applied, the contact surfaces move



relative to one another, causing adhesive wear (Xian and Zhang, 2005). Due to surface roughness, there are very few real contact surfaces between the items in adhesive wear, therefore even under very low load circumstances, the stresses at these spots surpass the yield stress limit (D'Antino et al., 2022). Due to this, even under light loads, the stresses at certain locations might approach the yield stress limit, causing plastic deformation and the creation of tiny welds that join the objects. The relative movement of the objects causes the weld joint to eventually shatter. The object's surface, which is softer than the surrounding material, develops cavities as a result of this break. Ridges appear on the opposite surface, and adhesive particles fill the gap between two surfaces.

GFRP composites find common use in motor vehicle chassis, bodies, interior walls, floors and doors. They are also employed in railway vehicle bodies, chassis, and brake shoes, as well as aerospace wing bodies and interior coatings (İlhan and Feyzullohoğlu, 2022). Wear is a common problem in many parts. Tribological studies have exposed composite materials to various conditions, including sliding and rolling against other materials. When determining the tribological behavior of materials, wear load, speed, wear time, or sliding distance are taken into consideration. Many studies have investigated the wear characteristics of FRP.

Pihtili and Tosun (2002), examined the wear characteristics of composite materials reinforced with glass fiber and simple polyester resin. In experimental experiments, they operated at varying loads (500 g and 1000 g) and speeds (500 and 710 r/min). They asserted that the wear resistance of GFRP composites was greater than that of regular polyester resin and that the load on wear effects the wear amounts more than the speed. In another study, abrasive wear tests of short glass fiber composites were carried out (Chand et al., 2000). They showed that when applied wear load was increased, the wear volume of composite materials increased too and the wear resistance increased, the wear amounts of GFRP materials decreased with the glass fiber reinforcement. Examined are the impacts of different resins, filler materials and adhesive wear factors on the tribological properties of GFRP composites, including varying loads and speeds (İlhan and Feyzullohoğlu, 2022). They concluded that the application of wear load on the wear characteristics of these materials is more effective than speed and that the glass fiber reinforcement improves the materials' resistance to wear.

In this study, adhesive wear properties of a commercial GFRP rod material were investigated. For the wear tests, steel disc used. Adhesive type wear method and block on ring were used as the wear mechanism.

## MATERIALS AND METHODS

The material for wear tests used in this study is commercial glass fiber rod material with a diameter of 10 mm. The wear samples were obtained by cutting this commercial glass fiber rod into 20 mm long pieces. Technical knowledge of the rod material is given in Table 1.

**Table 1.** Technical knowledge for the GFRP rod material

Technical Information		
Fiber type	E GLASS	
Resin type	VINLY EPOXY	
Fiber Content by Weight	>75	%
Fiber Content by Volume	>65	%
Tensile Strenth (Fiber Direction)	>1000	Mpa
Compression Strenth (Fiber Direction)	>550	Mpa
Tensile Modulus (Fiber Direction)	>38	Gpa
Density	>1,80	g/cm <sup>3</sup>



**Figure 1.** The main material (left) and a wear sample (right)

For wear tests, steel disc was used. Wear tests were carried out at speeds of 25 m/min and 50 m/min, wear distances of 400, 800 and 1200 m and force parameters of 5 N, 10 N and 15 N. The samples were weighed using a  $10^{-4}$  g accuracy scale. The samples were scaled once again and the wear amounts were computed following the designated wear times. Figure 1 shows the main material and cut sample for wear tests.

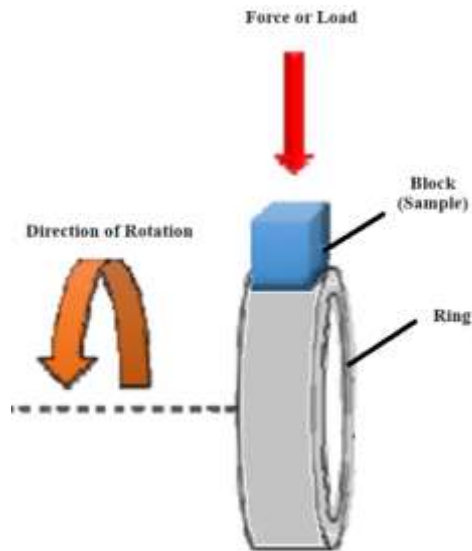
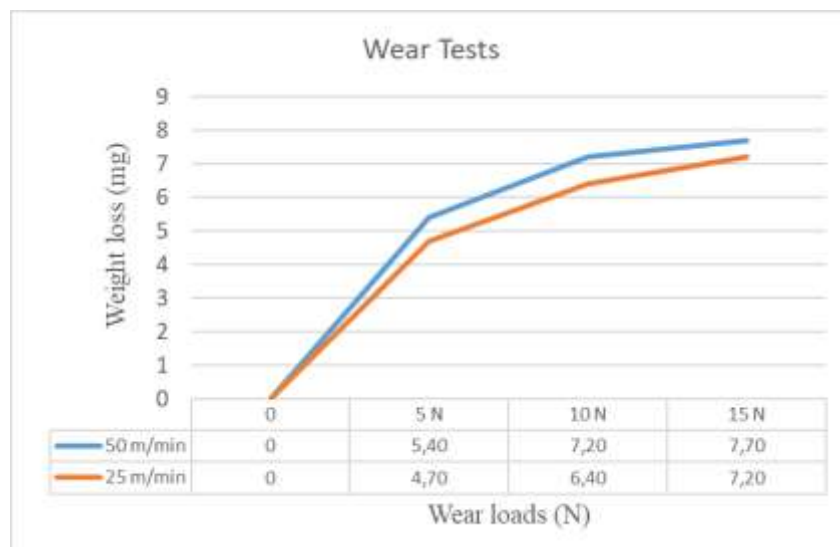

**Figure 2.** The wear test mechanism

The wear mechanism used for tests is seen in Figure 2. The samples were subjected to adhesive wear testing and in the Table 2, the results were given.

**Table 2.** Wear test results

Speed (m/min)	5 N			10 N			15 N		
	Wear Distance (m), Weight loss (mg)								
	400	800	1200	400	800	1200	400	800	1200
25	1,20	1,30	1,90	1,80	3,60	5,10	4,70	6,40	7,20
50	1,30	1,40	2,10	2,10	4,20	5,80	5,40	7,20	7,70



**Figure 3.** Graph of wear test results for 1200 m distance

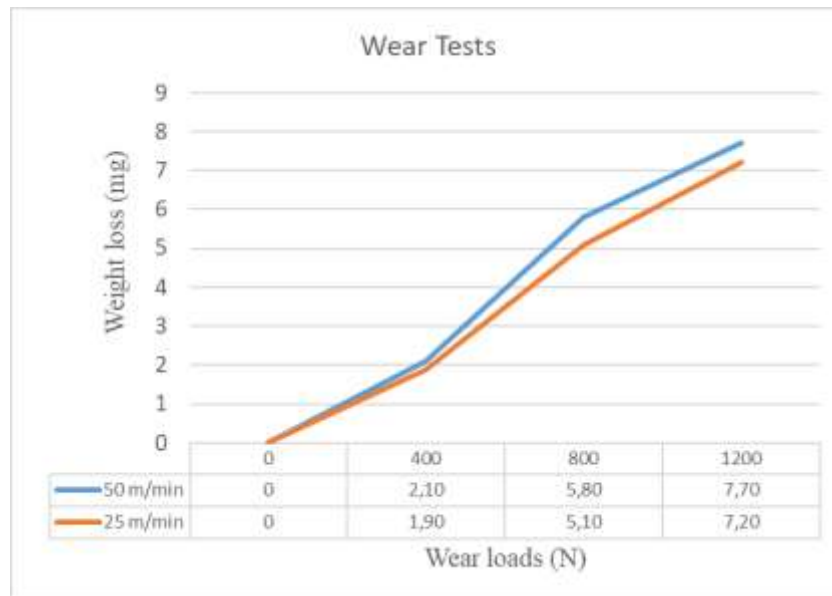

**Figure 4.** Graph of wear test results for 15 N load

Figure 3 and 4 show the wear results graphics for 1200 m distance and 15 N load. It is seen from the wear test results and the graphics that the wear speed, applied load and wear distance effect the wear results. As the wear time, wear rate and applied loads increase, the wear amount of the samples also increases in direct proportion to all of these. It can be noticed that the slopes of the blue and red curves seen in the graphs are really near to one another. This shows that the speed parameter affects the wear results slightly. However, from the graphs of Figure 3 and 4, it can be seen that the graphic curves change significantly from 400 m wear distance to 800 m distance and from 5 N wear load to 10 N load. So, when Table 2 and the graphs are taken into consideration and evaluated, it is understood that the parameters that affect the amount of wear the most are load and distance.

## CONCLUSION

This study reveals that the specimens' wear results differ according on the wear speed, applied force, and wear distance. As the wear time, wear speed and applied loads increase, the amount of wear of the specimens increases.

This study shows that for these composite materials, the wear load and wear distance or time parameters are more significant than the speed on the wear amounts.



## ACKNOWLEDGEMENT

I would like to thank Prof. Dr. Erol KILIÇKAP for his contributions to this study.

## REFERENCES

- Chand, N., Naik, A. and Neogi, S. (2000). Three-body abrasive wear of short glass fibre polyester composite. *Wear*, 242(1-2), 38-46.
- D'Antino, T., Pisani, M. A. and Poggi, C. (2022). Fatigue tensile testing of glass fiber-reinforced polymer reinforcing bars. *Construction and Building Materials*, 346, 128395.
- İlhan, R. and Feyzullahoğlu, E. (2022). Investigation of adhesive wear properties of glass fiber reinforced polyester composites having different chemical compositions. *Proceedings of the institution of mechanical engineers, part J: journal of engineering tribology*, 236(1), 156-173.
- Jesthi, D. K. and Nayak, R. K. (2019). Evaluation of mechanical properties and morphology of seawater aged carbon and glass fiber reinforced polymer hybrid composites. *Composites Part B: Engineering*, 174, 106980.
- Ohmae, N., Kobayashi, K. and Tsukizoe, T. (1974). Characteristics of fretting of carbon fibre reinforced plastics. *Wear*, 29(3), 345-353.
- Pıhtılı, H. and Tosun, N. (2002). Investigation of the wear behaviour of a glass-fibre-reinforced composite and plain polyester resin. *Composites Science and Technology*, 62(3), 367-370.
- Rajak, D. K., Wagh, P. H. and Linul, E. (2021). Manufacturing technologies of carbon/glass fiber-reinforced polymer composites and their properties: A review. *Polymers*, 13(21), 3721.
- Sathishkumar, T. P., Satheshkumar, S. and Naveen, J. (2014). Glass fiber-reinforced polymer composites—a review. *Journal of reinforced plastics and composites*, 33(13), 1258-1275.
- Weiland, K., Jones, M. P., Zinsser, F., Kontturi, E., Mautner, A. and Bismarck, A. (2021). Grow it yourself composites: Delignification and hybridisation of lignocellulosic material using animals and fungi. *Green Chemistry*, 23(19), 7506-7514.
- Xian, G. and Zhang, Z. (2005). Sliding wear of polyetherimide matrix composites: I. Influence of short carbon fibre reinforcement. *Wear*, 258(5-6), 776-782.



**PROXIMATE, VITAMINS, *IN VITRO* ANTIOXIDANT AND FUNCTIONAL ANALYSIS  
OF SOME POLYHERBAL FORMULATIONS AS POTENTIAL BOTANICAL  
CANDIDATES FOR PHARMACEUTICAL SCREENING. GINGER, GARLIC AND  
CLOVE (GGC)**

**Rawayau A. Mannir<sup>1</sup>, Sani A. Yandoma<sup>2</sup>, Muhammad F. Lawal<sup>3</sup>, Sani Ahmed<sup>4</sup>**

<sup>1,2,3</sup> Biochemistry Department, Umaru Musa Yaradua University Katsina, Nigeria

<sup>4</sup>Department of Statistics, Federal Teaching Hospital Katsina, Nigeria

**ABSTRACT**

The drawbacks and side effects of current medications have drawn interest in medicinal plants as possible sources of novel pharmacologically active molecules. This study delves into the medicinal possibilities of three widely utilised herbs: ginger (*Zingiber officinale*), garlic (*Allium sativum*), and clove (*Syzygium aromaticum*). Additionally, the study evaluates the combined formulations of these herbs through proximate analysis, antioxidant activity assessment, functionality tests, and vitamin composition determination. Proximate examination of several formulations revealed differences in the content of moisture, ash, protein, fat, fibre, and carbohydrates. The formulations' general nutritional profile appears to be constant despite variations in formulation, as indicated by statistical analysis that found no significant differences ( $P > 0.05$ ) between them. Analysis of vitamin compositions revealed clear differences between formulations, with varying amounts of Vitamins A, C, and E in each combination. Despite this, the ANOVA analysis revealed no statistically significant variations ( $P > 0.05$ ) in the vitamin makeup among the formulations, suggesting a rather consistent average vitamin content. Although statistical analysis showed no significant differences ( $P > 0.05$ ) in these functional qualities among the formulations, functional analysis showed variations in the formulations' capacity for absorbing glucose, oil, and water. With respect to antioxidant activity, the formulations displayed differing levels of DPPH scavenging activity; GG'C showed the greatest efficacy whereas GG' showed comparatively lesser scavenging capability. Significant variations in antioxidant activity ( $P > 0.05$ ) between formulations were verified by statistical analysis. These results call for more research and focused applications in medical settings by pointing to the possibility of using particular combinations of ginger, garlic, and clove to produce intended therapeutic benefits.

Keywords: Ginger, Garlic, Clove, polyherbal formulation, proximate, vitamins

**INTRODUCTION**

Medicinal plants have been a good source of new pharmacologically active molecules. For example, natural products could be a potential alternative for controlling the pathogen associated



with diseases (Ríos and Recio, 2015). Recently, antibiotics and most drugs on the market have shown unwanted symptoms and the emergence of resistant pathogenic microorganisms, toxic effects related to these drugs, and withdrawal issues restricting their use in many countries (Batiha *et al.*, 2019), therefore, much attention has been paid to the herbal extracts and pharmacologically active molecules extracted from different plant species that are used previously in the traditional medicine (Essawi and Srour, 2020). Many plant species have been reported to exert pharmacological properties due to their phyto constituents such as glycosides, alkaloids, saponins, steroids, flavonoids, tannins, and terpenoids (e.g., monoterpenes, diterpenes, and sesquiterpenes). Nowadays, eighty percent of the world's populations depend on traditional medicines as an

essential source of their primary health care (Batiha *et al.*, 2020). Medicinal plant extracts and their constituents also possess various biological activities including virucidal, bactericidal, fungicidal, anti-inflammatory, analgesic, sedative, spasmolytic, and local anesthetic activities among others (Bakkali *et al.*, 2018). Conventional drugs and or orthodox drugs shows a variety of side effect which is of a great concern on the health of individuals. Also the toxicity of the conventional drugs and or orthodox makes them sometimes not safer for consumption of the individuals. Microbial drug resistance upon several drug is of great concern and challenging issue upon consumption of conventional drugs and or orthodox drugs. Poverty and or expensiveness of drugs decreases the availability or access to many drugs by many individuals. The all above mentioned problems makes this research an important prospect that will addresses all the problems listed.

Garlic (*Allium sativum* L.; Family: Amaryllidaceae) is an aromatic herbaceous annual spice and one of the oldest authenticated and most important herbs that have been used from ancient times as traditional medicine (Bakkali *et al.*, 2018). It is considered the second broadly used *Allium* species with onion (*Allium cepa* L.), which is used as a remedy against several common diseases such are cold, influenza, snake bites, and hypertension. *Allium* species and their active components are reported to reduce the risk of diabetes and cardiovascular diseases, protect against infections by activating the immune system and have antimicrobial, antifungal, anti-aging as well as anticancer properties which confirmed by epidemiological data from human clinical studies (Barnes *et al.*, 2012).

Ginger (*Zingiber officinale*) is a major aromatic herb grown in Nigeria as a rhizome with sweet, strongly aromatic and sharp pungent flavour. Ginger is well known all over the world especially for its use in the treatment of gastrointestinal tract disorder such as constipation, dyspepsia and nausea. It was reported that ginger has medicinal properties against digestive disorders, rheumatism and diabetes (Afzal *et al.*, 2001). The consumption of ginger in led to reduction in blood cholesterol and also served as a potential antiinflammatory and antithrombotic agent (Thomson *et al.*, 2002).

Clove (*Syzygium aromaticum* (L.) is one of the most ancient and valuable spices of the Orient. It is a member of the family Myrtaceae. It is used in medicine for its antibacterial, antiseptic and antibiotic properties. It has also been successfully used for asthma and various allergic disorders by oral administration (Kim *et al.*, 2018). Sesquiterpenes, found in clove were also investigated as potential anti-carcinogenic agents (Zheng *et al.*, 2012). The oil has many industrial applications





and is used extensively in perfumes, soaps and as a clearing agent in histological work. In addition, the cloves are anti-mutagenic, (Miyazawa and Hisama, 2013) anti-inflammatory, (Kim *et al.*, 2018). antioxidant, (Chaieb *et al.*, 2013) antiviral, (Hussein *et al.*, 2010) anti-thrombotic (Srivastava *et al.*, 2021) and anti-parasitic (Yang *et al.*, 2013).

## **Methodology**

### **Sample Collection and Preparation**

Ginger and Garlic and clove were purchased from Chake local Market on July 3, 2023. The samples were washed properly with tap water and dried at room temperature. The dried samples were then grounded to powder.

### **Experimental Design**

The research is designed to take place as follows:

F1 (G): Ginger

F2 (G'): Garlic

F3 (C): Clove

F4 (GG'): Ginger + Garlic (1:1 W/W)

F5 (GC): Ginger + Clove (1:1 W/W)

F6 (G'C): Garlic + Clove (1:1 W/W)

F7 (GG'C): Ginger+ Garlic + Clove (1:1:1 W/W)

### **Proximate Analysis**

All the formulations were subjected to proximate analysis in accordance with the following established standard laboratory procedures (AOAC, 1990; AOCS, 2000). The proximate contents analyzed were moisture, crude protein, total ash, crude fiber, fat, and carbohydrate.

### **Vitamin Composition**



### **Determination of Vitamin A (Rutkowski *et al.*, 2007)**

#### **Procedure**

The analyzed liquid was measured, KOH solution added, heated, cooled, and centrifuged. The extracted extract was collected, separated, and measured for absorbance A1. The extract was then irradiated using UV light for 30 minutes, and absorbance A2 was measured.

Concentration of vitamin A was calculated using the formula.

$$A_x = (A1-A2) \times 22.23$$

### **Determination of Vitamin C (Rutkowski *et al.*, 2007);**

#### **Procedure**

Three centrifugal test tubes were used to analyze a sample, standard vitamin C, and distilled water. PR-reagent was added, mixed, and incubated for 30 minutes. The sample was centrifuged, and absorbance was measured. Vitamin C concentration was calculated in  $\mu\text{M}$  using the formula:

$$C_x = \frac{\text{Absorbance of sample}}{\text{Absorbance of standard}} \times \text{Concentration of standard (56.8 } \mu\text{M)}$$

*Absorbance of standard*

### **Determination of Vitamin E (Rutkowski *et al.*, 2007);**

The experiment involved preparing sample extract, standard, and water in centrifuge tubes, adding ethanol, water, xylene, and 2, 2'-dipyridyl reagent. The mixture was then pipetted into spectrophotometer cuvettes, and absorbance was measured at 460 nm. After 15 minutes, ferric chloride solution was added, and the amount of vitamin E was calculated using the formula.

$$\text{Vitamin E } (\mu\text{g/g}) = \frac{(\Delta A_{520\text{nm}} - \Delta A_{460\text{nm}}) \times \text{conc. [S]} \times 0.29 \times \text{Total volume}}{\Delta A_{520\text{nm}} \times \text{Vol for experiment} \times \text{Weight of sample}}$$

### **Functionality Test (AOAC, 2005)**



### **Water Absorption Capacity (WAC) Measurement;**

A weighed sample is placed in a glass beaker, diluted with 10ml of water, stirred, and allowed to stand for 30 minutes. Excess water is poured, and the absorption capacity is calculated using the formula:

$$\text{WAC} = [(\text{weight after absorption} - \text{initial weight of sample}) / \text{initial weight of Sample}] \times 100$$

### **Oil Absorption Capacity (OAC) Measurement;**

The steps above for WAC will be repeated, but food- grade vegetable oil will be used as the absorbing liquid instead of water. The oil absorption capacity will be calculated using the same formula as for WAC.

### **Glucose Absorption Capacity (GAC) Measurement:**

A 5% w/v glucose solution is prepared by dissolving glucose in distilled water. A sample is weighed, added to the solution, stirred, and allowed to stand for 1 hour. The sample is separated, and glucose concentration is measured using a spectrophotometer. The glucose absorption capacity will be calculated using the formula:

$$\text{GAC} = [(\text{initial glucose concentration} - \text{final glucose concentration}) / \text{initial glucose concentration}] \times 100$$

### **Antioxidant Activity (Siddharth *et al.*, 2020)**

### **DPPH (2,2-Diphenyl-1-picrylhydrazyl) Scavenging Assay;**

A stock solution of 24 milligrams of DPPH was prepared by dissolving it in 100 mL of methanol. The mixture was then combined with 100  $\mu$ L of sample extract in a test tube, and the absorbance was determined at 517 nm.

The following formula was used to compute the percentage of antioxidants or RSA

$$\% \text{ of antioxidant activity} = [(A_c - A_s) \div A_c] \times 100 \text{ where: } A_c \text{—Control reaction absorbance; } A_s \text{—Testing specimen absorbance}$$



## RESULTS AND DISCUSSION

### Proximate Analysis

Proximate analysis of different formulations (%) of Ginger, Garlic and Cloves

Figure 1 presents the proximate analysis of different formulations involving ginger, clove, and garlic, showing the mean percentage composition of various nutritional components. The data reveals insights into how the different combinations influence the nutritional content. Moisture content ranges from 8.8% in the G' to 12.37% in the GG' formulation. This indicates that the inclusion of ginger and garlic (GG') leads to a higher moisture content compared to the other formulations. The ash content, representing the mineral residue after complete combustion, shows variations among the formulations, with G' having the lowest at 5.4% and G'C having the highest at 10.35%.

The GG'C formulation stands out with the highest crude protein content at 3.39%, indicating that the combination of ginger, garlic, and clove leads to a formulation richer in protein compared to others. Also, GG'C also exhibits the highest fat content at 14.3% and the highest crude fiber at 22.5% among the formulations, suggesting that this combination might offer a higher concentration of these nutritional elements.

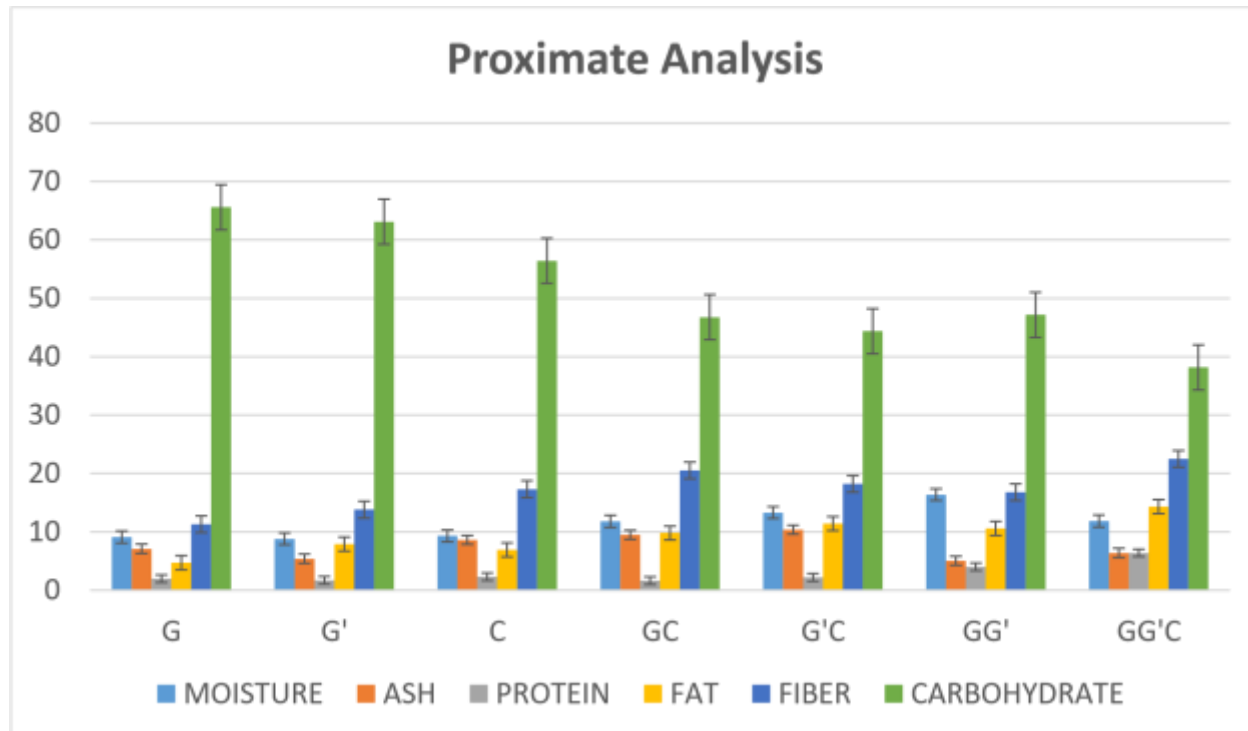



**KEY: G= Ginger, G'= Garlic, C= Clove, GG'= Ginger + Garlic, GC= Ginger + Clove, G'C=**

**Garlic + Clove, GG'C= Ginger + Garlic + Clove**

Despite these variations, the ANOVA indicates that there is no significant difference ( $P > 0.05$ ) in the percentage proximate composition among the different formulations. This implies that, while there are noticeable differences in the nutritional content across the combinations, these differences are not statistically significant, suggesting a level of consistency in the overall nutritional profile regardless of the specific combination of ginger, garlic, and clove.

**Figure 2. Vitamin composition**

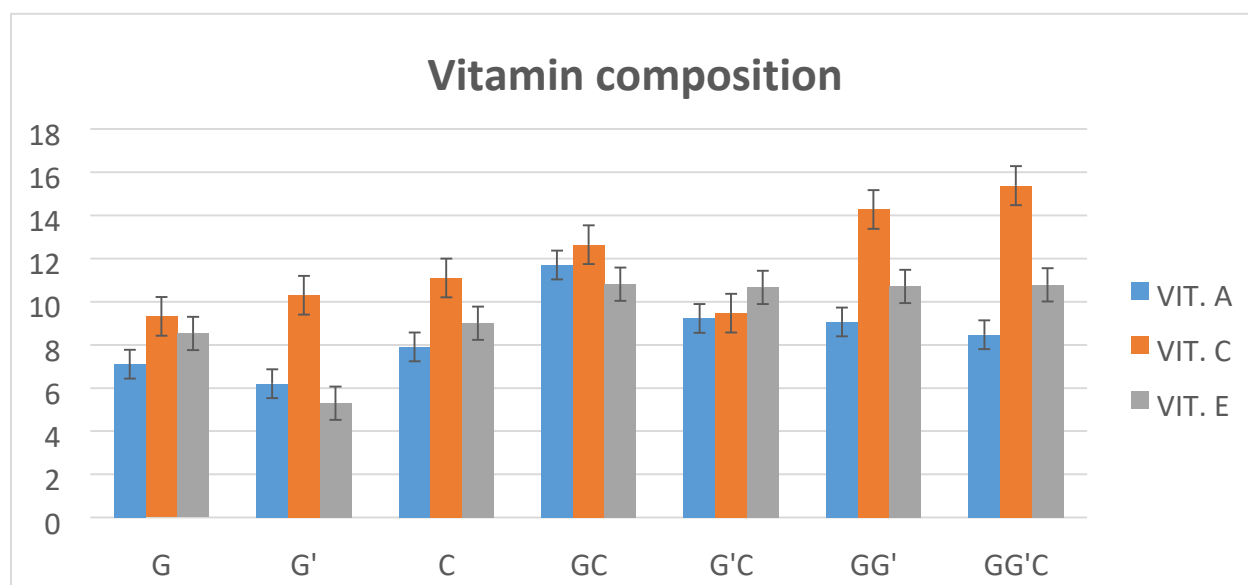

**KEY: G= Ginger, G'= Garlic, C= Clove, GG'= Ginger + Garlic, GC= Ginger + Clove, G'C=**

**Garlic + Clove, GG'C= Ginger + Garlic + Clove**

The figure above presents a comprehensive view of the vitamin composition in different formulations involving ginger, clove, and garlic. It provides data on the concentrations of Vitamins A, C, and E, essential nutrients with diverse roles in the body's function and health. The result reveals the interesting variations in vitamin content among the formulations. The GC formulation presents the highest concentration of Vitamin A at 11.7 mg/ml, while the GG'C formulation shows the lowest at 8.47 mg/ml. Similarly, Vitamin C content ranges from 12.64 mg/ml in GC to 15.38 mg/ml in GG'C, indicating notable variations in the content of this essential vitamin across the different combinations. Additionally, the Vitamin E content remains relatively consistent across the formulations, fluctuating within a narrow range of concentrations.



ANOVA indicates that there is no significant difference ( $P > 0.05$ ) in vitamin composition among the formulations. This suggests that, on average, the vitamin content remains relatively stable across the different combinations of ginger, clove, and garlic.

Figure 3. Functional analysis

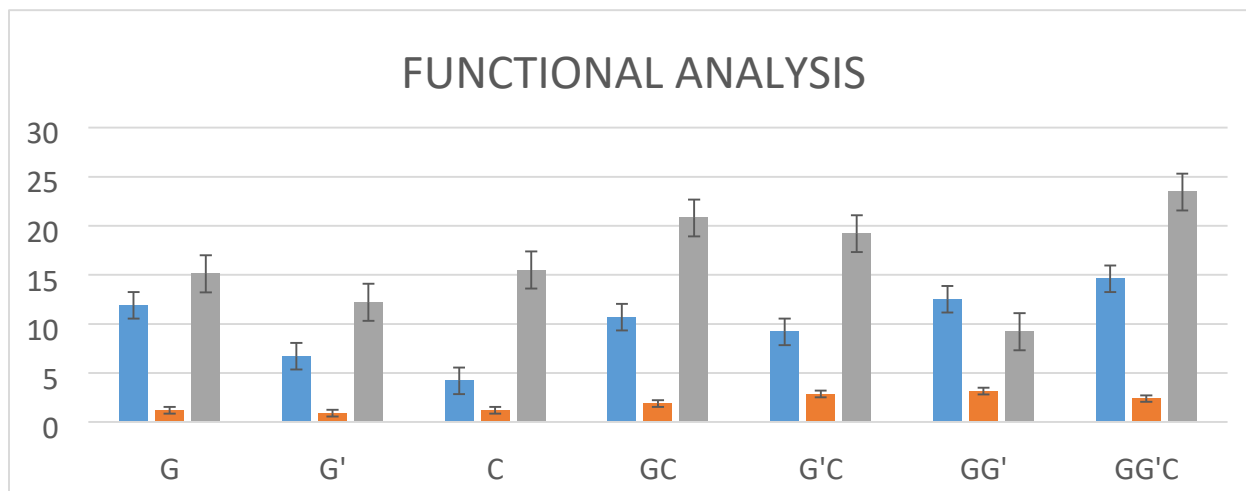

**KEY:** G= Ginger, G'= Garlic, C= Clove, GG'= Ginger + Garlic, GC= Ginger + Clove, G'C=

Garlic + Clove, GG'C= Ginger + Garlic + Clove

Table 3 above presents the functional analysis data, focusing on the glucose adsorption capacity (GAC), oil adsorption capacity (OAC), and water adsorption capacity (WAC) of different formulations involving ginger, clove, and garlic. The data reveals variations in the functional properties across the different combinations of ingredients. The GG'C formulation stands out with the highest values in GAC (glucose adsorption capacity) at 14.6%, indicating its potential to adsorb glucose effectively. On the other hand, G'C shows the highest OAC (oil adsorption capacity) at 2.86%, suggesting its efficiency in absorbing oil content. In contrast, GG' has the lowest WAC (water adsorption capacity) at 9.2%, highlighting its lower capacity to absorb water compared to the other formulations.

The statistical analysis (ANOVA) indicates no significant difference ( $P > 0.05$ ) in the percentage mean of the GAC, OAC, and WAC across the formulations. This suggests that, on average, the functional properties remain relatively consistent irrespective of the specific combination of ginger, clove, and garlic used.

Figure 4. DPPH Scavenging Activity

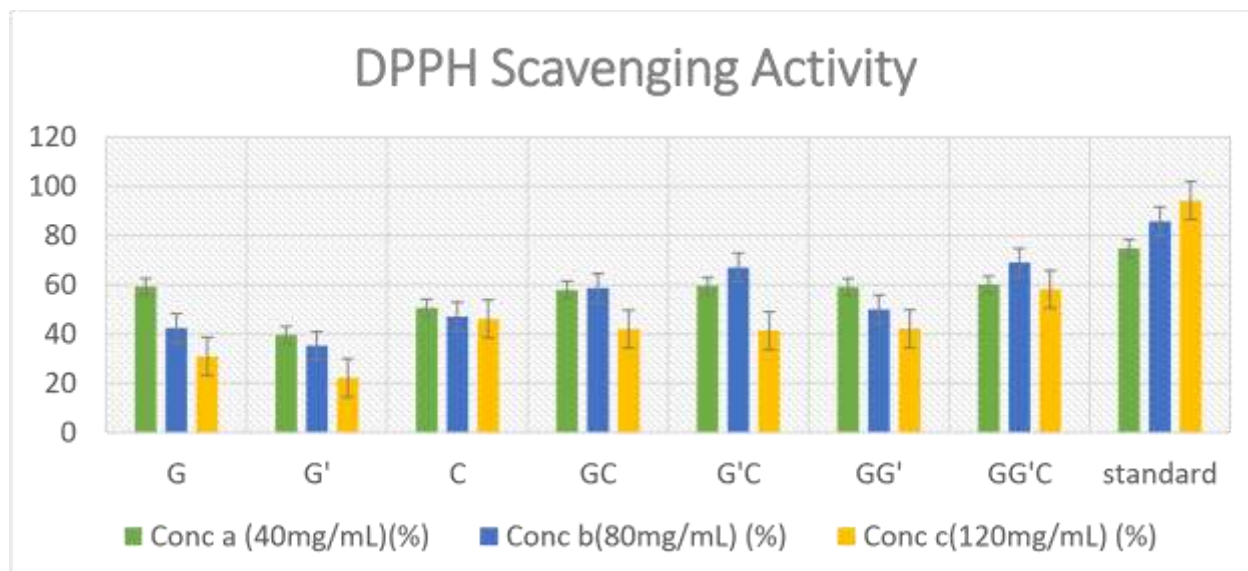

**KEY: G= Ginger, G'= Garlic, C= Clove, GG'= Ginger + Garlic, GC= Ginger + Clove, G'C= Garlic + Clove, GG'C= Ginger + Garlic + Clove**

Table 4 above focuses on the DPPH (2,2-diphenyl-1-picrylhydrazyl) scavenging activity of various formulations containing ginger, clove, and garlic. The data reveals significant differences in the antioxidant activity among the formulations. Specifically, the GG'C formulation displays the highest scavenging activity across all concentrations (40mg/mL, 80mg/mL, 120mg/mL), indicating its potent antioxidant capacity. In contrast, the GG' formulation exhibits comparatively lower scavenging activity, particularly at the highest concentration (120mg/mL).

The statistical analysis further validates these observed differences, indicating a significant difference ( $P < 0.05$ ) in the percentage mean of the DPPH scavenging activity across the formulations. Posthoc analysis highlights that GG'C significantly differs from GG, demonstrating a notably higher antioxidant capacity. On the other hand, GC and G'C formulations show no significant differences in their scavenging abilities, suggesting a level of similarity in their antioxidant potential.

### CONCLUSION

The proximate analysis shows no significant difference among the formulations ( $p > 0.05$ ) with GG'C showing a nutritional profile shift because of the combination of the herbs than single herbs. The vitamin composition, vitamin A displays pattern among the formulations with GC showing higher value than other formulations which are in turn better than the single herbs. Vitamin C fluctuates across the formulations, GG'C displays higher while G shows the lowest. Vitamin E content remains relatively stable among the formulations with a difference from the single herbs. In the functional properties, GAC displays notable variations among the formulations. GGC exhibits the highest GAC indicating its superior ability to absorb glucose. Other formulations and the single herbs shows the comparatively lower GAC value. WAC also varies among the formulations. GG' displays lower WAC compared to GG'C. The single herbs show the lowest



WAC. OAC shows intriguing trends across the formulations. GGC and GC exhibit similar OAC. There is no significant difference ( $p>0.05$ ). In the antioxidant activity, GGC shows slightly higher scavenging activity in 40, 80 and 120mg/ml concentrations than other formulations. The ANOVA results indicating no significant difference ( $p>0.05$ ), the slightly higher values in GGC warrant further exploration.

## RECOMMENDATION

The results of this study suggest that the combination of ginger, garlic and cloves may be a viable option for the development of nutraceuticals. Further research is needed to determine the optimal ratios and processing methods for this combination (TCM) to achieve a desired nutrient content.

## REFERENCE

- Aakriti Garg... Snoop Kumar (2022). An overview: Food auto-oxidation. *Antioxidants Effects in health* 2010;14:510-6. 2020; **27(4):1326**
- Abraham T, Girma Y, Hailey K, Haiku M, Hirai S, Hailemariam M (2016). Prevalence and associated factors of clinical manifestations of Vitamin A deficiency among preschool children in asgede-tsimbla rural district, North Ethiopia, a community based cross sectional study. *Arch Public Health* . **74(1):4**
- Abubakar Mannir Rawayau, M.K Atiku, Abubakar Ishaq Nuhu, Salisu Abubakar (2022). A preliminary study: Proximate composition and functional analysis of some Polyherbal formulations as botanical candidates for antidiabetic screening. *Dutse Journal of Pure and Applied Sciences*. **8(2a):140-148**
- Aditi Mulgund MD... Ashok Agarwal (2015). The Role of Oxidative Stress in Endometriosis. *Handbook of Fertility*.
- Afzal, M., Al Hadidi, D., Menon, M., Pesek, J., & Dhimi, M.S. (2001). Ginger: An ethnomedical, chemical and pharmacological review. *Drug Metabolism Drug Interactions*, 18, 159-190.
- Afzal, M., Al Hadidi, D., Menon, M., Pesek, J., & Dhimi, M.S. (2001). Ginger: An ethnomedical, chemical and pharmacological review. *Drug Metabolism Drug Interactions*, 18, 159-190. *Aliment*. 2007; **6(3) 17-28**
- Alkali, H. M, Tahir, A. D, Dankadi, H. (2023). Analysis of mint leaves Marketing in potiskum Local Government Area of Yobe State, Nigeria. *International Journal of Agribusiness and Economic Grow*. **10(5).1-10**





ATLAS 11. INTERNATIONAL  
CONGRESS ON ADVANCED SCIENTIFIC STUDIES AND INTERDISCIPLINARY RESEARCH

---

- Analytical Chemists, Inc.  
Antioxidative Vitamins Determination Convenient In Analytic Practice. *Acta Sci. Pol., Technol.*  
AOAC (1990). Official Methods of Analysis (18th Ed.). Washington DC, USA: Association of Official  
AOAC (1990). Official Methods of Analysis (18th Ed.). Washington DC, USA: Association of  
Official Analytical Chemists, Inc.
- AOCS (2000). Free fatty acids in crude and refined oils method 26.042. In: Firestone, D. (Ed.), Official  
AOCS (2000). Free fatty acids in crude and refined oils method 26.042. In: Firestone, D. (Ed.),  
Official Methods and Recommended Practices of the American Oil Chemists' Society.  
AOAC Press, Champaign III, USA.
- Ashraf, R., S. Ghufuran, S. Akram, M. Mushtaq and B. Sultana (2020). Cold pressed Coriander  
(*Coriandrum sativum L.*) seed oil. *Cold pressed oils, Elsevier*: **345-356**.
- Association of official Analytical Chemist (AOAC) (2005). Official methods of analysis 18th Ed.  
The Association of Official Analytical Chemists, Washington DC, USA
- Aunyachulee Ganogpichayagrai and Chutinan Suksaard (2020). Proximate composition, vitamin  
and mineral composition, antioxidant capacity, and anticancer activity of *Acanthopanax*  
*trifoliatus*. *Journal of Advanced Pharmaceutical Technology & Research*. **11 (4): 179- 183**.
- Bakkali, F.; Averbeck, S.; Averbeck, D.; Idaomar, M. Biological effects of essential oils—A  
review. *Food Chem. Toxicol.* 2018, 46, 446–475.  
Bakkali, F.; Averbeck, S.; Averbeck, D.; Idaomar, M. Biological effects of essential oils—A  
review. *Food Chem. Toxicol.* 2018, 46, 446–475.
- Barnes, J.; Anderson, L.A.; Phillipson, J.D. Herbal Medicines, 2nd ed.; Pharmaceutical Press:  
Barnes, J.; Anderson, L.A.; Phillipson, J.D. Herbal Medicines, 2nd ed.; Pharmaceutical Press:  
London, UK, 2012; Volume 14
- Batiha, G.E.S.; Beshbishy, A.M.; Tayebwa, D.S.; Adeyemi, O.S.; Shaheen, H.; Yokoyama, N.;  
Igarashi, I. Evaluation of the inhibitory effect of ivermectin on the growth of Babesia and  
Theileria parasites in vitro and in vivo. *Trop. Med. Health* 2019, 47, 42.  
Batiha, G.E.S.; Beshbishy, A.M.; Tayebwa, D.S.; Adeyemi, O.S.; Shaheen, H.; Yokoyama, N.;  
Igarashi, I. Evaluation of the inhibitory effect of ivermectin on the growth of Babesia and  
Theileria parasites in vitro and in vivo. *Trop. Med. Health* 2019, 47, 42.



- Batiha, G.-S.; Alkazmi, L.M.; Nadwa, E.H.; Rashwan, E.K.; Beshbishy, A.M. Physostigmine: A plant alkaloid isolated from *Physostigma venenosum*: A review on pharmacokinetics, pharmacological and toxicological activities. *J. Drug Deliv. Ther.* 2020, 10, 187–190.
- Batiha, G.-S.; Alkazmi, L.M.; Nadwa, E.H.; Rashwan, E.K.; Beshbishy, A.M. Physostigmine: A plant alkaloid isolated from *Physostigma venenosum*: A review on pharmacokinetics, pharmacological and toxicological activities. *J. Drug Deliv. Ther.* 2020, 10, 187–190.
- Batiha, G.-S.; Alkazmi, L.M.; Wasef, L.G.; Beshbishy, A.M.; Nadwa, E.H.; Rashwan, E.K. *Syzygium aromaticum* L. (Myrtaceae): Traditional uses, bioactive chemical constituents, pharmacological and toxicological activities. *Biomolecules* 2020, 10, 202.
- Batiha, G.-S.; Alkazmi, L.M.; Wasef, L.G.; Beshbishy, A.M.; Nadwa, E.H.; Rashwan, E.K. *Syzygium aromaticum* L. (Myrtaceae): Traditional uses, bioactive chemical constituents, pharmacological and toxicological activities. *Biomolecules* 2020, 10, 202.
- Beshbishy, A.M.; Batiha, G.E.S.; Adeyemi, O.S.; Yokoyama, N.; Igarashi, I. Inhibitory effects of methanolic *Olea europaea* and acetonic *Acacia laeta* on the growth of *Babesia* and *Theileria*. *Asian Pac. J. Trop. Med.* 2019, 12, 425–434.
- Beshbishy, A.M.; Batiha, G.E.S.; Adeyemi, O.S.; Yokoyama, N.; Igarashi, I. Inhibitory effects of methanolic *Olea europaea* and acetonic *Acacia laeta* on the growth of *Babesia* and *Theileria*. *Asian Pac. J. Trop. Med.* 2019, 12, 425–434.
- Bohra Laribi, Karima Kouki, Mahmoud M' Itamdi, Taoufik Bettaieb (2015). Review: Coriander (*Coriandrum sativum* L.) and its bioactive constituents. *Fitoterapia*. **103: 9-26.**
- Chaieb K, Zmantar T, Ksouri R, Hajlaoui H, Mahdouani K, Abdelly C, Bakhrouf A. Antioxidant properties of essential oil of *Eugenia caryophyllata* and its antifungal activity against a large number of clinical *Candida* species. *J Mycosis* 2017b;50(5):403-6.
- Chaieb K, Zmantar T, Ksouri R, Hajlaoui H, Mahdouani K, Abdelly C, Bakhrouf A. Antioxidant properties of essential oil of *Eugenia caryophyllata* and its antifungal activity against a large number of clinical *Candida* species. *J Mycosis* 2017b;50(5):403-6.
- Ditte B. Hermund (2018). Antioxidant Properties of Seaweed-Derived Substances. *Bioactive seaweeds for food Applications*
- Encyclopedia Britannica (2023). Coriander herb and spice



- Essawi, T.; Srour, M. Screening of some Palestinian medicinal plants for antibacterial activity. *J. Ethnopharmacol.* 2020, 70, 343–349.
- Essawi, T.; Srour, M. Screening of some Palestinian medicinal plants for antibacterial activity. *J. Ethnopharmacol.* 2020, 70, 343–349.
- Ferraro PM, Curhan GC, Gambano G, Taylor EN (2016). Total, dietary and supplemental Vitamin C intake and risk of incident kidney stones. *Am J kidney Dis.* **67(3):400-407**
- Gamal Osman Elhassan, Mohd Masih Uzzaman Khan, Habibullah Khalillulah, Eltayeb E.M.Eid (2016). A review. Nutraceuticals: An opportunity of Health Care. *Tropical Journal of pharmaceutical Research.* **5 (11): 229-239**
- Hannington Twinomuhwezi, Chinaza Godswill Awechi, Mihigo Racheal (2020). Comparative study of the proximate composition and Functional Properties of Composite Flours of Amaranth, Rice, Millet, and Soybean. *American Journal of Food Science and Nutrition.* **6: 6-19**
- Harold I. Zeliger (2023). Disease prevention. *Oxidative Stress.*
- Helberg, Julian; Pratt, Derek A. (2021). "Autoxidation vs Antioxidants - the fight for forever". *Chemical Society Review.* **50(13): 7343-7358**
- Hussein G, Miyashiro H, Nakamura N, Hattori M, Kakiuchi N, Shimotohno K. Inhibitory effects of Sudanese medical plant extracts on hepatitis C virus (HCV) protease. *J Phytother Res*
- Hussein G, Miyashiro H, Nakamura N, Hattori M, Kakiuchi N, Shimotohno K. Inhibitory effects of Sudanese medical plant extracts on hepatitis C virus (HCV) protease. *J Phytother Res* 2010;14:510-6.
- J Prostaglandins Leukot Essent Fatty Acids 2021;42(1):73-81.
- Jain S, Purohit A, Nema P, Vishwakarma H, Jain PK, (2022). A Brief Review on Nutraceuticals Antioxidants *Journal of Dental and Health Sciences.* **2(1):7-1**
- James, S. C. (1995). Experimental Methods. *Analytical Chemistry of Foods, Chapman and Hall, New York.* **28.**
- Jean M. Bokelmann MD (2022). Peppermint (*Mentha pipeta*) in Medical Herbs. primary care
- João S. Teodoro,... Carlos M. Palmeira (2016). Mitochondria as a Target for Safety and Toxicity Evaluation of Nutraceuticals. *Nutraceuticals*



- Joseph Eishenseher MD, MAT (2018). Peptic Ulcer Disease. *Integrative Medicine* (fourth edition)
- K V Narayana Saibaba (2023). Next generation Biosurfactants and their Practical Application in the Food Sector. *Applications of Next Generation Biosurfactants in The Food Sector*.
- Kathleen M. Zelman, RD,LD,MPH (2023). Health Benefits of Mint Leaves.
- Khalfan Mohamed Abdulla Al Naqbi, Khandhan Karthishwaran, Shyam Sreedhara Kurup, Mohammed Abdul Muhsen Alyafei and Abdul Jaleel (2022). Phytochemicals, proximate composition, Mineral analysis and in vitro Antioxidant Activity of Calligonum crinitum Boiss. *Horticulture*. **8 (2), 156**
- Kim HM, Lee EH, Hong SH, Song HJ, Shin MK, Kim SH, Shin TY. Effect of Syzygium aromaticum extract on immediate hypersensitivity in rat. *J Ethnopharmacol* 2018;60:125-31.
- Kim HM, Lee EH, Hong SH, Song HJ, Shin MK, Kim SH, Shin TY. Effect of Syzygium aromaticum extract on immediate hypersensitivity in rat. *J Ethnopharmacol* 2018;60:125-31.
- L. Wilson (2016). Spices and flavouring crops: Leaf and floral structures. *Encyclopedia of Food and Health*.
- L.) inhibits aggregation and alters arachidonic acid metabolism in human blood platelets.
- Lihua Ye, Gary S. El-Mesery, Muhammad Muzamal Ashfaq, Yefan Shi, Hu Zicheng, W. G. Alshaer (2021). Analysis of energy and specific energy requirements in various drying process of mint leaves. *Case studies in Thermal Engineering*. **26:101113**
- London, UK, 2012; Volume 14
- Lykstad J, Sharma S (2019). Biochemistry, Water soluble Vitamins. *Stat Pearls. Treasure Island*
- Maciej Rutkowski, Krzysztof Grzegorzczak. Modifications Of Spectrophotometric Methods For Antioxidative Vitamins Determination Convenient In Analytic Practice. *Acta Sci. Pol., Technol. Aliment.* 2007; **6(3) 17-28**
- Majedul Hoque (2023). A review on Different Dietary Sources of Important Vitamins and Electrolytes. *International Journal of Research Publication and Reviews*. **4(8):731-736**.
- Methods and Recommended Practices of the American Oil Chemists' Society. AOAC Press, Champaign III, USA.



- Miyazawa M, Hisama M. Antimutagenic activity of phenylpropanoides from clove (*Syzygium aromaticum*). *J Agric Food Chem* 2013;51(22):6413-22.
- Miyazawa M, Hisama M. Antimutagenic activity of phenylpropanoides from clove (*Syzygium aromaticum*). *J Agric Food Chem* 2013;51(22):6413-22.
- Muhammad H. Alu'datt,...Mervat Rawshdeh (2018). Pharmaceutical, Nutraceutical and Therapeutic Properties of selected Wild Plants: Thyme, Spear mint and Rosemary, in Therapeutic, probiotic and unconventional foods.
- P.Joshi, G S Yadae, S. Joshi, R. B. Semwal, D. K. Semwal (2020). Antioxidant and anti-inflammatory activities of selected medicinal herbs and their Polyherbal olypherbal formulation. *South African journal of Botany*. **130: 440-447**
- Pati Pandey, and Chung-Ming Chang. Determination of Antioxidants by DPPH Radical Ring Tsao (2015). Synergistic Interactions between Antioxidants used in Food Preservation. *Handbook of Antioxidants for Food Preservation*
- Ríos, J.L.; Recio, M.C. Medicinal plants and antimicrobial activity. *J. Ethnopharmacol.* 2015, 100, Ríos, J.L.; Recio, M.C. Medicinal plants and antimicrobial activity. *J. Ethnopharmacol.* 2015, 100, 80–84. [CrossRef] [PubMed] *Nutrients* 2020, 12, 872 15 of 21
- Sadaf Anwar, Mohd Adnan Kausar, Kehkasha Parveen, Aqeela Zahra, Abrar Ali, Riadh Badraoui, Mejdi Snoussi, Waseem A. Siddiqui, Mohd Saeed (2023). Polyherbal formulation: The studies towards identification of composition and their biological activities. *Journal of king Suad University-science*. **34(7): 102256**
- Sakshi Manocha, Shivani Dhiman, Ajmer Singh Grewal, Kumar Guarve (2022). "Nanotechnology: An approach to Overcome Bioavailability Challenges of Nutraceuticals". *Journal of Drug Delivery Science and Technology*. **72: 103418**
- Samir Sxander; Claudia Zadra; Maria Carla Marcotullio (2023). Review: Coriander (*Coriandrum sativum*) Polyphenols and their Nutraceutical Value against Obesity and Metabolic syndrome. *Molecules*. **28 (10)**
- Sarita karole, Sarika Shrivastava, Shefali Thomas, Bhawana Soni, Shifa Khan, Julekha Dubey, Nushrat Khan, Deepaj Kumar Jain (2019). A review: Polyherbal formulation concept for synergic Action. *Journal of Drug Delivery and Therapeutics*. **9: NO I-S**
- Scavenging Activity and Quantitative Phytochemical Analysis of *Ficus religiosa*. *Molecules*.



Shaubhik Anand, Navneeta Bharadvaja (2022). Potential Benefits of Nutraceuticals for Oxidative stress Management. *Revista Brasileira de Farmcognosia* **32** (2).

Doi://10.1007/s43450.022-00246-w [researchgate]

Shyamapada Mandal, Manisha Mandal (2015). **Review article: Coriander (Coriandrum sativum L.)** Essential oil chemistry and biological activity. *Asian Pacific Journal of Tropical Biomedicine* **5(6):422-428**

Siddartha Baliyan, Riya Mukherjee, Anjali Priyadarshini, Arpana Vibhuti, 1 Archana Gupta, Ramendra Siddartha Baliyan, Riya Mukherjee, Anjali Priyadarshini, Arpana Vibhuti, 1 Archana Gupta,

Ramendra Pati Pandey, and Chung-Ming Chang. Determination of Antioxidants by DPPH

Radical Scavenging Activity and Quantitative Phytochemical Analysis of *Ficus religiosa*.

*Molecules*. 2020; **27(4):1326**

Srivastava KC, Malhotra N. Acetyl eugenol, a component of oil of cloves (*Syzygium aromaticum* Srivastava KC, Malhotra N. Acetyl eugenol, a component of oil of cloves (*Syzygium aromaticum*

L.) inhibits aggregation and alters arachidonic acid metabolism in human blood platelets.

*J Prostaglandins Leukot Essent Fatty Acids* 2021;42(1):73-81.

Thomson, M., Al-Quattan, K.K., Al-Sawan, S.M., Alnaqeeb, M.A., Khan, I., & Ali, M. (2002). The use of ginger (*Zingiber officinale* Rosc) as a potential anti-inflammatory and antithrombotic agent. *Prostaglandins, Leukotrienes and Essential Fatty Acids*, **67** (6), 475-478.

Thomson, M., Al-Quattan, K.K., Al-Sawan, S.M., Alnaqeeb, M.A., Khan, I., & Ali, M. (2002).

The use of ginger (*Zingiber officinale* Rosc) as a potential anti-inflammatory and

antithrombotic agent. *Prostaglandins, Leukotrienes and Essential Fatty Acids*, **67** (6), 475-

478.

Vivek Puri, Manju Nagpal, Inderbir Singh, Gitika Arora Dhingra, Kampanart Huanbutta, Divya Dheer, Ameya Sharma, Tarikan Sangnim (2022). "A comprehensive review on Nutraceuticals: Therapy support and Formulation Challenges ". *Nutrients* **14(21):4637**.



ATLAS 11. INTERNATIONAL  
CONGRESS ON ADVANCED SCIENTIFIC STUDIES AND INTERDISCIPLINARY RESEARCH

---

Yang YC, Lee SH, Lee WJ, Choi DH, Ahn YJ. Ovicidal and adulticidal effects of *Eugenia cryophyllata* bud and leaf oil compounds on *Pediculus capitis*. *J Agric Food Chem* 2013;51(17):4884-8

Yang YC, Lee SH, Lee WJ, Choi DH, Ahn YJ. Ovicidal and adulticidal effects of *Eugenia cryophyllata* bud and leaf oil compounds on *Pediculus capitis*. *J Agric Food Chem* 2013;51(17):4884-8

Zheng GQ, Kenny PM, Lam KT. Sesquiterpenes from clove (*Eugenia carrophyllata*) as potential anticarcinogenic agents. *J Nat Prod* 2012;55:999-1003.

Zheng GQ, Kenny PM, Lam KT. Sesquiterpenes from clove (*Eugenia carrophyllata*) as potential anticarcinogenic agents. *J Nat Prod* 2012;55:999-1003.



**VOL À LA TIRE À ISTANBUL (1934-1935)**  
**PICKPOCKETING IN ISTANBUL (1934-1935)**

**Dr. Mustafa KOÇ**

Candidate au doctorat, Université d'Istanbul, Département d'histoire, Istanbul/Turquie.

ORCID ID: 0000-0001-6441-6273

**RÉSUMÉ**

Cette étude se concentre sur les incidents de vol à la tire à Istanbul entre 1934 et 1935 et examine les processus de réaction des victimes et des services de sécurité face au vol à la tire. Les principales questions de recherche sont les suivantes : « *Dans quels quartiers le vol à la tire est-il concentré à Istanbul ?* », « *Quelles mesures de sécurité ont été prises contre le vol à la tire à Istanbul ?* », « *Quel type de comportement les criminels ont-ils manifesté au cours des poursuites et de la procédure judiciaire ?* ». La méthode de l'étude est l'analyse de cas et de discours ; les principales sources sont des journaux d'époque tels que *Cumhuriyet*, *Milliyet*, *Vakit*, *Son Posta*, *Tan* et *Akşam*. Les sources ont été consultées dans le catalogue des journaux de la bibliothèque d'État d'Istanbul Bayezit. En outre, le portail en ligne du projet « *Regarder des journaux à l'histoire* » de l'Université d'Istanbul a été utilisé. Les documents montrent que les lieux du crime sont des endroits fréquemment utilisés et très fréquentés, tels que les tramways, les ferries, les embarcadères et les ponts. Les objets volés comprennent de l'argent, des portefeuilles, des documents de valeur, des sacs, des montres, des étuis à cigarettes, des lires en or jaune. Galata, Beyoğlu, Tophane, Sultanahmet, Beşiktaş, Unkapanı, Samatya, Edirnekapi sont les quartiers les plus courants où des vols à la tire ont eu lieu. La plupart des vols à la tire ont eu lieu lors d'un voyage, de l'achat d'un billet ou de l'observation de quelque chose ou d'un lieu. L'exemple le plus intéressant est le vol du portefeuille et de l'argent de Ramazan qui observait un ours dans la rue à Beyoğlu. Parmi les exemples, 80 kuruş volés dans la poche de Bedri est la plus petite somme d'argent détectée. Les 500 lires volées à un ingénieur bulgare nommé İstilo İstilofon constituent la plus grosse somme d'argent retrouvée. La plupart des voleurs à la tire arrêtés étaient des criminels ayant un casier judiciaire, comme Limoncu Nuri, un voleur à la tire de 22 ans ayant déjà fait l'objet de 22 condamnations. Certains voleurs à la tire avaient même des surnoms, tels que Piç Agop, Papelci Mehmet, İzmirli Davit, Balath Vagnel, Parmaksız Ali. Les résultats montrent que la police et les agents de police sont chargés d'attraper les voleurs à la tire et de les remettre aux autorités judiciaires, que les voleurs à la tire sont condamnés à des peines d'emprisonnement pour des périodes allant de trois mois à un an et que les voleurs à la tire commettent plus d'une infraction à la fois. Par ailleurs, la négation du délit est la caractéristique typologique la plus marquante des voleurs à la tire.

**Mots-clés** : Vol à la tire, Istanbul, sécurité urbaine.





## ABSTRACT

This study focuses on the incidents of pickpocketing in Istanbul between 1934 and 1935 and investigates the response processes of victims and security units to pickpocketing. Main research questions were determined as "In which neighbourhoods was pickpocketing intense in Istanbul?", "Which security measures were taken against pickpocketing in Istanbul?", "Which behaviours did the offenders show during the trial and law court process?" Method of the study is case and discourse analysis, and the main sources are newspapers of the period such as *Cumhuriyet*, *Milliyet*, *Vakit*, *Son Posta*, *Tan* and *Akşam*. The sources were accessed through the Newspaper Catalogue of İstanbul Bayezit State Library. In addition, Istanbul University's *Online Portal of a Glance from Newspaper to History* was used. The material shows that crime scenes were frequently used and crowded places such as trams, ferries, piers and bridges. Stolen items included money, wallet, valuable documents, bags, watches, cigarette cases, and yellow gold liras. Galata, Beyoğlu, Tophane, Sultanahmet, Beşiktaş, Unkapanı, Samatya, Edirnekapı were the neighbourhoods where pickpocketing took place the most. Most pickpocketing incidents took place while travelling, buying a ticket and while watching something/some place. The most interesting example is the theft of Ramazan's wallet and money while watching a bear on the Street in Beyoğlu. Of the examples, 80 kuruş stolen from Bedri's pocket is the lowest money identified. The highest amount of money stolen is 500 liras stolen from a Bulgarian engineer named İstilo İstilofon. Most of the pickpockets caught were criminals with criminal records such as Limoncu Nuri, who was a 22-year-old pickpocket with 22 criminal records. Some pickpockets even had nicknames such as Piç Agop, Papelci Mehmet, İzmirli Davit, Balatlı Vagnel, Parmaksız Ali. The results show that police and the municipal police were responsible for catching the pickpockets and handing them to judicial authorities, the pickpockets were sentenced to imprisonment for various periods of time ranging from three months to one year and pickpockets committed more than one crime. In addition, denial of being guilty was the most prominent typological characteristic of the pickpockets.

**Key Words:** Pickpocketing, Istanbul, urban security.

## Introduction

Le vol à la tire est un type de vol. Le vol à la tire est défini comme le vol d'un objet sur une personne, un corps ou un lieu directement lié au corps, par un tour de passe-passe et une certaine dextérité.<sup>1</sup> Sur la base de cette définition, la problématique principale de cette étude est la suivante : « *Quelles sont les motivations des incidents de vol à la tire à Istanbul ?* ». La méthode de l'étude a été déterminée comme étant l'analyse de cas et de discours. Les principales sources de l'étude sont les journaux *Son Posta*, *Milliyet*, *Akşam*, *Yeni Asır*, *Vakit*, *Zaman*, *Kurun*, *Haber*,

---

<sup>1</sup> Mustafa Emrah Şeyhanlıoğlu, « *Theft crime* », (Université d'Ankara, thèse), 2010, p. 110.



*Ulusal Birlik, Tan, Cumhuriyet, Türk Dili et Anadolu*. Les journaux ont été consultés via le catalogue des journaux de la bibliothèque d'État d'Istanbul Beyazıt et le portail en ligne du projet de *Gazeteden Tarihe Bakış de l'université d'Istanbul*. La première raison du choix d'Istanbul pour l'étude est liée à la population. En effet, le vol à la tire est un type de vol commis dans des lieux très fréquentés. Au cours de cette période, 681 048 personnes vivaient dans la partie européenne d'Istanbul et 202 366 dans la partie asiatique.<sup>2</sup> La deuxième raison est que le nombre de journaux publiés à Istanbul est plus élevé que dans les autres provinces. Cependant, le vol à la tire n'est pas un crime spécifique à Istanbul. C'est un délit qui n'est plus courant qu'à Istanbul. Les incidents de vol à la tire survenus dans d'autres provinces au cours de la même période confirment également ce point de vue. Par exemple, Ayı Mehmet et son complice Kayserili Hasan, qui se déplaçaient dans de nombreuses provinces et districts de Turquie pour pratiquer le vol à la tire, ont été arrêtés à Adana.<sup>3</sup> Dans la rue Karşıyaka Kemalpaşa à İzmir,<sup>4</sup> deux voleurs à la tire, Bahriye et Elif, ont volé 61 liras dans la poche d'Ali Ramazan qui faisait ses courses chez un marchand de légumes.<sup>5</sup> Un autre exemple similaire est le vol du portefeuille de Mustafa Efendi, imam de la mosquée Sheikh à Alaşehir, par un voleur à la tire. Les voleurs à la tire ont pris 5 liras dans le portefeuille et ont laissé le portefeuille vide devant l'établissement de bains de la ville.<sup>6</sup>

La Turquie dispose d'une littérature abondante en matière de vols. Il n'en va pas de même pour le vol à la tire. Cependant, j'ai décidé de réaliser cette étude après avoir lu « Research in urban history : recent theses on crime in the city, 1750-1900 » de Neale<sup>7</sup> et « Bustling, crowding, and pushing : pickpockets and the nineteenth-century street crowd » d'Andersson.<sup>8</sup> Pour le contexte théorique de l'étude, j'ai utilisé *The Oxford Handbook of Criminal Law*<sup>9</sup> édité par Dubber et Hörnle et les thèses de Salkaya, Nacak et Ediş (avec le même titre).<sup>10</sup> Je dois dire que j'ai trouvé

<sup>2</sup> *Population de la Turquie 20 octobre 1935*, Présidence du Conseil Office Central de Statistique, Ankara: Ulus Basımevi, 1935, p. 9.

<sup>3</sup> « Ayı Mehmet et ses amis capturés », *Vakit*, n° 6008, 28 septembre 1934, p. 8.

<sup>4</sup> Pour d'autres incidents de vol à la tire à İzmir, voir. « Un voleur à la tire », *Yeni Asır*, n° 8790, 4 novembre 1934, p. 4. ; « Vol à la tire », *Yeni Asır*, n° 8864, 3 février 1935, p. 7. ; « Vol à la tire vigilant », *Yeni Asır*, n° 8871, 22 février 1935, p. 2. ; « Vol à la tire », *Yeni Asır*, n° 8943, 19 mai 1935, p. 6. ; « Femme voleuse à la tire », *Yeni Asır*, n° 8983, 4 juillet 1935, p. 7. ; « Le vol à la tire avec un casier judiciaire », *Yeni Asır*, n° 8989, 11 juillet 1935, p. 4. ; « Vol à la tire », *Yeni Asır*, n° 9118, 17 décembre 1935, p. 6.

<sup>5</sup> « Les filles volées à la tire », *Haber*, n° 1256, 7 juillet 1935, p. 8.

<sup>6</sup> « Un vol à la tire à Alaşehir », *Son Posta*, n° 1383, 1 juin 1934, p. 4.

<sup>7</sup> Matt Neale, « Research in urban history: recent theses on crime in the city, 1750-1900 », *Urban History*, n° 40/3, août 2013, p. 567-577.

<sup>8</sup> Peter K. Andersson, « Bustling, crowding, and pushing: pickpockets and the nineteenth-century street crowd », *Urban History*, n° 41/2, mai 2014, p. 291-310.

<sup>9</sup> *The Oxford handbook of criminal law*, (éditée par Markus D. Dubber et Tatjana Hörnle), Oxford : Oxford University Press, 2014.

<sup>10</sup> Didem Salkaya, « *The crime of robbery* », (Université de Marmara, thèse), 2010. ; Mehmet Nacak, « *Theft crime* », (Université du 9-Septembre, thèse), 2013. ; Ege Ediş, « *Crime of theft* », (Université d'Ankara, thèse), 2020.



que les ouvrages de Şensoy (*Basit Hırsızlık ve Çeşitli Mevsuf Hırsızlıklar*),<sup>11</sup> Erdener (*Malvarlığına Karşı Suçlar*),<sup>12</sup> Noyan (*Hırsızlık Suçları*)<sup>13</sup> et Kıyak (*Umumi ve Hususi Kanunlarda Hırsızlık Cürümleri ve Tatbikatı*)<sup>14</sup> valaient la peine d'être examinés, en particulier dans la littérature.

### 1. J'ai commencé à crier à tue-tête : Il y a un voleur à la tire! Il y a un voleur à la tire !<sup>15</sup>

Le délit de vol à la tire était défini dans le code pénal de l'époque (article 491) comme « *Si le vol est commis à la tire, la peine est une peine d'emprisonnement de six mois à un an* ». <sup>16</sup> Il s'agissait d'un délit fréquemment commis dans les lieux publics tels que les places, les ponts, les tramways, les ferries et les embarcadères d'Istanbul. Des exemples montrent que l'infraction de vol à la tire est commise par distraction ou en profitant de la distraction. Les modalités de l'infraction sont particulièrement frappantes. Par exemple, Baloncu Remzi avait l'habitude de voler les gens en salissant leurs vêtements. Il a volé le portefeuille et l'argent de l'homme dont il avait sali la veste en disant « *Ne t'inquiète pas, nous allons l'essuyer, il ne restera rien* »<sup>17</sup> ; l'Albanais Sabri d'Adapazar (avec ses amis Niğdeli Hüseyin, Papelci Mehmet et Konyalı Haydar) a volé le portefeuille de Süleyman dans sa poche, qu'il a serré autour de son cou en disant « *Papa, tu ne me reconnais pas ? je suis ton beau-fils* ». <sup>18</sup> On constate également que la même méthode est appliquée par Hüseyin. En serrant le cou de Kosti, un vieil homme rencontré à Eminönü, et en disant « *Oh mon père, cela fait longtemps que je ne t'ai pas vu* », Hüseyin a volé 10 liras dans la poche de Kosti.<sup>19</sup> En outre, la femme copte qui a volé 24 liras à Şevket Efendi à Edirnekapı sous le prétexte de dire la bonne aventure<sup>20</sup> et Bekir qui a volé le portefeuille de Ramazan en regardant l'ours dans la rue à Beyoğlu font partie des voleurs à la tire qui ont utilisé des méthodes intéressantes.<sup>21</sup>

Les informations judiciaires publiées dans les journaux révèlent que des voleurs à la tire ont été condamnés à des peines d'emprisonnement et à des amendes. Limoncu Nuri, qui a volé 55 liras à İbrahim Efendi à Balıkpazarı, est l'un d'entre eux. Nuri, qui a déclaré au tribunal qu'il était vendeur de citrons, a déclaré qu'il n'avait rien à voir avec le vol à la tire et qu'il avait été

<sup>11</sup> Naci Şensoy, *Basit Hırsızlık ve Çeşitli Mevsuf Hırsızlıklar*, İstanbul : Nazir Akbasan Matbaası, 1963.

<sup>12</sup> Erdener Yurtcan, *Malvarlığına Karşı Suçlar*, İstanbul : Beta Yayınları, 2008.

<sup>13</sup> Erdal Noyan, *Hırsızlık Suçları*, Ankara : Adalet Yayınevi, 2007.

<sup>14</sup> Fahrettin Kıyak, *Umumi ve Hususi Kanunlarda Hırsızlık Cürümleri ve Tatbikatı*, Giresun : Yeşilgireson Matbaası, 1953.

<sup>15</sup> « Comment Bekir le voleur a-t-il dépouillé Ali et Kâzim à Rize ? », *Son Posta*, n° 1784, 22 juillet 1935, p. 10.

<sup>16</sup> « Comment la loi punit-elle les voleurs à la tire ? », *Tan*, n° 799, 10 juillet 1937, p. 5.

<sup>17</sup> « Un voleur à la tire », *Milliyet*, n° 2873, 8 février 1934, p. 3.

<sup>18</sup> « Des voleurs envoyés au tribunal », *Türk Dili*, n° 9570, 14 février 1935, p. 2.

<sup>19</sup> « Deux voleurs à la tire arrêtés », *Son Posta*, n° 1881, 27 octobre 1935, p. 2.

<sup>20</sup> « Ils ont volé le portefeuille alors qu'ils lisaient un livre de bonne aventure », *Akşam*, n° 5647, 30 juin 1934, p. 3.

<sup>21</sup> « Il a perdu l'argent qu'il avait dans sa poche à cause d'un voleur à la tire », *Akşam*, n° 5944, 8 mai 1935, p. 3.



calomnié. Nuri, 22 ans, a été reconnu coupable de 22 infractions pénales.<sup>22</sup> Un autre exemple est celui de Muzaffer, qui a été jugé par la troisième cour pénale. Muzaffer a été condamné à trois mois de prison pour vol à la tire. Comme Muzaffer avait un casier judiciaire, 15 jours ont été ajoutés à sa peine.<sup>23</sup> Les autres voleurs à la tire condamnés à trois mois de prison sont Mehmet et İbrahim. Mehmet, qui a été pris en flagrant délit alors qu'il volait le sac à main d'une femme dans un tramway, a été condamné à trois mois et 22 jours de prison et à une amende de 30 liras.<sup>24</sup> En outre, Recep et Niyazi, qui ont volé le sac à main et 19 liras d'une femme nommée Mebrure Hanım dans le tramway, ont été condamnés à sept mois de prison en raison de leur casier judiciaire,<sup>25</sup> et Hayati, qui a été reconnu coupable d'avoir cassé la montre du capitaine Mehmet à Tophane, a été condamné à un an de prison.<sup>26</sup>

**Tableau 1 :** Informations sur les voleurs à la tire

n°	Voleur à la tire	Victime	Scène du crime	Biens volés
1	Hüseyin	Ville	tramway	montre en or <sup>27</sup>
2	Cevat	Cemal	marché	100 lire <sup>28</sup>
3	Mehmet	Muzaffer	à Samatya	argent <sup>29</sup>
4	Ayşe	Zehra	pont	portefeuille <sup>30</sup>
5	Agop	Bedri	<i>*non spécifié</i>	80 kurus <sup>31</sup>
6	Mişon	Muazzez	tunnel	sac à main <sup>32</sup>
7	Rıza	Ziya İhsan	tramway	montre en or <sup>33</sup>
8	Süruri	Haşim	tramway	100 lire <sup>34</sup>
9	Mustafa	Vagnel	tramway	130 lire <sup>35</sup>
10	Hakkı	<i>*non spécifié</i>	tramway	300 lire <sup>36</sup>
11	Abdurrahman	İlya	tramway	80 lire <sup>37</sup>

<sup>22</sup> « 22 ans, 22 condamnations », *Milliyet*, n° 2855, 21 janvier 1934, p. 3.

<sup>23</sup> « Un voleur à la tire arrêté », *Milliyet*, n° 2861, 27 janvier 1934, p. 3.

<sup>24</sup> « Décisions d'emprisonnement », *Zaman*, n° 92, 10 septembre 1934, p. 5.

<sup>25</sup> « Deux voleurs à la tire condamnés », *Vakit*, n° 6033, 23 octobre 1934, p. 4.

<sup>26</sup> « Un voleur à la tire arrêté », *Milliyet*, n° 2932, 11 avril 1934, p. 6.

<sup>27</sup> « Un voleur à la tire », *Milliyet*, n° 2853, 17 janvier 1934, p. 3.

<sup>28</sup> « Un voleur à la tire attrapé », *Son Posta*, n° 1413, 1 juillet 1934, p. 2.

<sup>29</sup> « Nouvelles des dernières 24 heures », *Son Posta*, n° 1449, 6 août 1934, p. 2.

<sup>30</sup> « Aisha la voleuse », *Vakit*, n° 5981, 1 septembre 1934, p. 3.

<sup>31</sup> « Un voleur à la tire attrapé dans un tramway », *Akşam*, n° 5943, 7 mai 1935, p. 4.

<sup>32</sup> « Mishon le voleur à la tire », *Akşam*, n° 5946, 10 mai 1935, p. 3.

<sup>33</sup> « Pris en flagrant délit de vol de la montre et du cordon d'un passager », *Akşam*, n° 5962, 26 mai 1935, p. 3.

<sup>34</sup> « Trois voleurs à la tire attrapés », *Son Posta*, n° 1740, 8 juin 1935, p. 2.

<sup>35</sup> « Un voleur à la tire a été arrêté », *Son Posta*, n° 1747, 15 juin 1935, p. 15.

<sup>36</sup> « Vol à la tire dans le tramway », *Kurun*, n° 6287, 11 juillet 1935, p. 8.

<sup>37</sup> « Nouvelles brèves », *Tan*, n° 116, 16 août 1935, p. 6.



12	Veysi	Eşref	quai	sac à main <sup>38</sup>
13	Hüseyin	Mustafa	tramway	montre <sup>39</sup>
14	Nasri	Ahmed	à Küçükpazar	portefeuille <sup>40</sup>

La peine la plus lourde a été infligée à un voleur à la tire nommé Muzaffer. Muzaffer a renversé une femme nommée Mükerrerem et a volé 35 liras dans le portefeuille de Mükerrerem. Muzaffer a été attrapé après que Mükerrerem a crié « *J'ai laissé tomber mon argent* » et a été condamné à un an et deux mois de prison.<sup>41</sup> En outre, les articles analysés ont montré qu'il existait un lien entre le fait que les voleurs à la tire aient un casier judiciaire et le fait qu'ils soient considérés comme célèbres. Le plus connu des voleurs à la tire célèbres de l'époque est Baloncu Hakkı. Hakkı coupe la veste de Şemseddin avec une lame de rasoir dans le tramway de Beşiktaş et vole 300 liras. Mais baloncu Hakkı était poursuivi par la police à ce moment-là et a été rattrapé avant de pouvoir s'échapper. L'argent qu'il avait volé a été rendu à son propriétaire.<sup>42</sup> Un autre voleurs à la tire célèbre est Agop et Davit. La première photo montre Piç Agop et la seconde Davit d'Izmir (avec le visage coupé) - et Agop.<sup>43</sup> Tous deux ont commencé à voler à la tire à un très jeune âge, selon les termes du journal *Son Posta*. Agop et Davit, qui ont volé 500 liras, un plateau d'argent, une lire d'or et une montre en or à l'ingénieur bulgare Istilo Istilofon dans le tramway, ont été rattrapés après une course-poursuite avec la police. Les photos publiées dans la presse ont été prises après cet incident. La plupart des objets volés ont été restitués à Istilo par la police.<sup>44</sup> La seule femme voleuse à la tire célèbre dans les journaux est Refika. Refika est coupable d'avoir volé des portefeuilles et de l'argent sur les quais, dans les tramways et les ferries. Au cours de l'enquête, la police a déterminé que Refika avait volé dans les environs de Galata et l'a rattrapée après une course-poursuite.<sup>45</sup> Toutefois, ces exemples ne signifient pas que tous les voleurs à la tire sont identifiés. Ainsi, le voleur à la tire qui a dérobé 3 liras à Hacı Cemal Efendi à Beşiktaş<sup>46</sup> et le voleur à la tire qui a dérobé 140 liras à Süleyman Efendi à Üsküdar n'ont pas pu être identifiés.<sup>47</sup>

## Conclusion

1- Les données montrent que les voleurs à la tire étaient des récidivistes et de nombreux exemples indiquent que les individus ont fait de ce crime une profession. En outre, il ne serait pas faux de qualifier le vol à la tire de crime commis principalement par des hommes à Istanbul

<sup>38</sup> « Nouvelles brèves », *Tan*, n° 158, 27 septembre 1935, p. 10.

<sup>39</sup> « Deux voleurs à la tire arrêtés », *Son Posta*, n° 1920, 5 décembre 1935, p. 2.

<sup>40</sup> « Les vols », *Son Posta*, n° 1936, 21 décembre 1935, p. 12.

<sup>41</sup> « Un voleur à la tire condamné », *Tan*, n° 152, 21 septembre 1935, p. 2.

<sup>42</sup> « Contre les bandits civilisés », *Son Posta*, n° 1773, 11 juillet 1935, p. 2.

<sup>43</sup> *Son Posta*, n° 1795, 2 août 1935, p. 2. ; *Tan*, n° 3405, 2 août 1935, p. 6.

<sup>44</sup> « Deux voleurs à la tire de Mahir arrêtés », *Son Posta*, n° 1795, 2 août 1935, p. 2. ; « Deux voleurs à la tire criminel arrêtés », *Cumhuriyet*, n° 4028, 2 août 1935, p. 6.

<sup>45</sup> « Un voleur à la tire condamné à une peine de prison », *Akşam*, n° 5550, 22 mars 1934, p. 3.

<sup>46</sup> « Nouvelles des dernières 24 heures », *Son Posta*, n° 1376, 25 mai 1934, p. 2.

<sup>47</sup> « Vol à la tire », *Milliyet*, n° 3094, 20 septembre 1934, p. 3.

en 1934 et 1935. J'ai commencé l'étude en pensant qu'il y aurait un large éventail de méthodes de délinquance, mais les données suggèrent qu'il y a des méthodes standard de délinquance et que les délinquants répètent ces méthodes.

2- À l'exception de quelques exemples, le vol à la tire à Istanbul était un délit individuel. En fait, on rapporte que les voleurs à la tire qui ne parvenaient pas à se mettre d'accord sur l'argent se battaient entre eux pendant cette période (voir, la bagarre entre le voleur à la tire Parmaksız Ali et Andavallı Ahmet).<sup>48</sup>

3- La récidive fréquente suggère que les sanctions ne sont pas dissuasives. Selon les données, les principales caractéristiques du profil des délinquants sont la répétition des infractions, la négation de l'infraction, la négation, le parjure et la fuite devant les unités de sécurité.

### Critique

Tout au long de l'étude, les questions « *À quoi ressemble un voleur à la tire ?* » et « *Quel genre de vêtements le voleur à la tire préférerait-il porter ?* » je me suis curieux. J'ai donc repris l'étude depuis le début et j'ai parcouru les nouvelles sur le vol à la tire entre 1932 et 1938. Je n'ai pu accéder qu'à 5 photographies datant de 1937 et 1938. Les photographies que j'ai trouvées avaient un format similaire à celui des photos d'identité judiciaire. Je n'ai donc pas pu trouver la réponse à la question que je me posais.



Cependant, j'ai rencontré des données plus intéressantes dans le cadre de cette recherche : les enfants voleurs à la tire. Par exemple, Burhan, dont les photos figurent ci-dessus, est âgé de 15 ans et Ahmet de 12 ans. C'est pourquoi le sujet des « *enfants voleurs à la tire* » est ouvert à tous les chercheurs en sciences sociales qui souhaitent l'étudier.

<sup>48</sup> *Zaman*, n° 209, 17 janvier 1935, p. 3.

<sup>49</sup> *Haber*, n° 1981, 20 juillet 1937, p. 6.

<sup>50</sup> *Cumhuriyet*, n° 5083, 8 juillet 1938, p. 2.

<sup>51</sup> *Kurun*, n° 7428, 14 septembre 1938, p. 3.

<sup>52</sup> *Son Posta*, n° 2829, 16 juin 1938, p. 4.

<sup>53</sup> *Son Posta*, n° 2829, 16 juin 1938, p. 4.



## Références

*Akşam, Cumhuriyet, Haber, Kurun, Milliyet, Son Posta, Tan, Türk Dili, Vakit, Yeni Asır, Zaman.*

*Population de la Turquie 20 octobre 1935, Présidence du Conseil Office Central de Statistique, Ankara: Ulus Basımevi, 1935.*

Şeyhanlıođlu, Mustafa Emrah ; « *Theft crime* », (Université d'Ankara, thèse), 2010.



## GUT DYSBIOSIS IN DOGS WITH SPINAL CORD INJURY: IMPACT OF POLENOPLASMIN

**Major Gheorghe GIURGIU**

Deniplant-Aide Sante Medical Center, Biomedicine, Bucharest, Romania

<https://orcid.org/0000-0002-5449-2712>

**Prof. Dr. Manole COJOCARU<sup>2</sup>, ARS, SciRes I, EuSpLM**

Titu Maiorescu University, Faculty of Medicine, Bucharest, Romania

<https://orcid.org/0000-0002-7192-7490>

### ABSTRACT

Background Studies have demonstrated the presence of gut dysbiosis (alterations in gut bacterial homeostasis) secondary to spinal cord injury in dogs. The dysbiosis is thought to impair recovery by decreasing the production of short-chain fatty acids which play a role in suppressing inflammation within the central nervous system.

Objective Therefore, targeting gut dysbiosis could have significant therapeutic value in the management of spinal cord injury. The purpose of this study is to determine if gut dysbiosis occurs in dogs with spinal cord injury. Another area of potential intervention interest is in situations of spinal injury where there is an urgent need to generate new neurons. To arrive at these observations, the authors examined how Polenoplasmin and diet solve paralysis in dogs.

Materials and methods The most common cause of spinal problems in dogs is trauma. We are currently assessing whether indoles can also stimulate formation of neurons in dogs with paralysis.

Results We found that gut microbes that metabolize tryptophan-an essential amino acid-secrete small molecules called indoles, which stimulate the development of new brain cells in dogs, also demonstrated that the indole-mediated signals elicit key regulatory factors known to be important for the formation of new neurons.

Conclusion This study is another intriguing piece of the puzzle highlighting the importance of lifestyle factors and diet.

In conclusion, the link between the health of the microbiome and the health of the brain shows how microorganisms in the gut solve paralysis. Gut microbe secreted molecule linked to formation of new nerve cells in paralysed dogs.

**Keywords:** intestinal dysbiosis, indoles, paralysed dog, Polenoplasmin.





**EXPLORING EMPLOYMENT SUCCESS OF LEARNERS WITH DISABILITIES  
UPON GRADUATION FROM HAIRDRESSING PROGRAM IN SELECTED  
BENINESE VOCATIONAL AND TECHNICAL EDUCATION CENTRES.**

**Jean-Marc GNONLONFOUN**

GRI-DIGEST/LARPET/ENSETLOK/UNSTIM-A EREDD/LARESTI/PAY ONG, Benin  
Republic, West Africa

**ABSTRACT**

This study investigates the employment success of learners with disabilities and their worker trait characteristics for the Hairdressing trade program in Vocational and Technical Education Centres of Abomey, Dogbo, Athiémé and Sè. Based on the existing literature and legislation, the content for a structured interview made up of thirty-eight items which addressed background data, worker trait characteristics, and vocational training was developed and used to survey former 40 students selected from the classes of 2015, 2016 and 2017 and their employers on the rate of 10 students per identified school. Responses from 30 students were considered valid. Comparisons were drawn between ratings of learners with disabilities, non-disabled learners, and their employers for responses to be broken down into sub-groups of special needs learners and their employers, and non-special needs learners and their employers. Data analysis indicated that employers of disabled learners rated 55% of their employees' worker trait characteristics as fair to good and 45% from good to very good, while employers of non-special needs learners rated 10% of their employees' worker trait characteristics as fair to good and 90% from good to very good. Therefore, it is clear that vocational learners with disabilities in Hairdressing know employment success. As such, vocational education is one of the ways to empower people with disabilities.

**Keywords:** learners with disabilities-hairdressing-VET-empowerment



## IBUPROFEN CONJUGATED SULFONAMIDES AS UREASE INHIBITORS

**Dr. Mahmood AHMED**

Department of Chemistry, Division of Science and Technology, University of Education,  
Lahore-Pakistan,

ORCID. <http://orcid.org/0000-0002-2285-7406>

### ABSTRACT

The development of novel scaffolds that can increase the effectiveness, safety, and convenience of medication therapy using drug conjugates is a promising strategy. As a result, drug conjugates are an active area of research and development in the medicinal chemistry. This research demonstrates the acetamide-sulfonamide scaffolds preparation after conjugation of ibuprofen with sulfa drugs, and these scaffolds were screened for the urease inhibition. The newly designed conjugates were confirmed by spectroscopic techniques like IR, <sup>1</sup>HNMR, <sup>13</sup>CNMR, and elemental analysis. Ibuprofen conjugated with sulfathiazole, was found potent and demonstrated competitive mode of urease inhibition, with IC<sub>50</sub> (μM) values 9.95±0.14, and urease inhibition was 90.6, respectively. Ibuprofen conjugated with sulfanilamide, sulfamerazine, and sulfacetamide, exhibited mixed mode of urease inhibition. Moreover, through molecular docking experiments, the urease receptor binding mechanisms of competitive inhibitors were anticipated. The findings demonstrated that conjugates of approved therapeutic molecules may result in the development of novel classes of pharmacological agents for the treatment of various pathological conditions involving the urease enzyme.

**Keywords:** Sulfonamides, NSAIDs, Urease, In-silico studies



## IDENTIFICATION OF NOVEL POTENTIAL ACETYLCHOLINESTERASE INHIBITORS THROUGH 3D-QSAR, DOCKING AND MOLECULAR DYNAMICS SIMULATIONS TARGETING ALZHEIMER'S DISEASE

Khalil El khatabi<sup>1\*</sup>, Mohammed Aziz Ajana<sup>1</sup>, Tahar Lakhlifi<sup>1</sup>, Mohammed Bouachrine<sup>1,2</sup>

<sup>1</sup>Molecular chemistry and Natural Substances Laboratory, Faculty of Science, University Moulay Ismail, Meknes, Morocco.

<sup>2</sup>EST Khenifra, Sultan Moulay Sliman University, Beni mellal, Morocco.

Alzheimer's disease (AD) is the most common progressive neurodegenerative disorder that always related to a decline of memory and cognitive functions [1]. As yet, neither preventative cure nor a satisfying therapy is available at the present. There are several drug targets which are reported to control the severe level of Alzheimer's disease, among which acetylcholinesterase enzyme is approached as a good drug targets for this disease [2]. Hence, the present study mainly focused to discover newly N-Benzylpyrrolidine based derivatives as potential acetylcholinesterase inhibitors drug through several computational approaches. A dataset of N-Benzylpyrrolidine based derivatives previously synthesized and evaluated for acetylcholinesterase inhibitory activity was studied by using three-dimensional quantitative structure-activity relationship (3D-QSAR) study, revealing the key structural factors of acetylcholinesterase inhibitors [3].

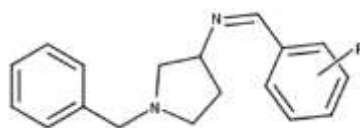

Fig. 1: The structural template of the N-benzylpyrrolidine derivatives.

Furthermore, molecular docking and molecular dynamics simulation were explored to reveal the binding mode between the selected molecules and the acetylcholinesterase receptor. The generation of 3D-QSAR pharmacophore models were followed by its validation exhibited predictive power for the experimental inhibitory concentration (IC) values. The molecular features characteristics provided by the 3D-QSAR contour plots were quite useful for designing six new compounds with high predicted potency. The designed molecules were further subjected to molecular docking and molecular dynamic simulation studies and compared to the most active compound. The identified structure features for acetylcholinesterase inhibition through docking study showed a satisfactory correlation with the 3D-QSAR study.

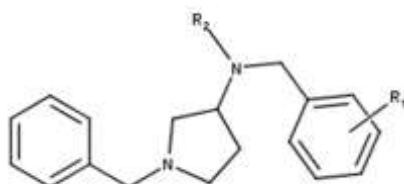

Fig. 2: The structural template of the newly designed molecules.

The comparison illustrated that designed molecule combined with acetylcholinesterase were more stable than the most active compound with the same targeted receptor. The results would provide valuable guidance for designing new reversible acetylcholinesterase inhibitors in the future.



## References

- [1] M. Xu, Y. Peng, L. Zhu, S. Wang, J. Ji, K. P. Rakesh, *Eur. J. Med. Chem.* **2019**, *180*, 656.
- [2] K. El Khatabi, I. Aanouz, R. El-mernissi, A. Khaldan, M. A. Ajana, M. Bouachrine, T. Lakhlifi, *Orbital Electron. J. Chem.* **2020**, *12*, 172.
- [3] P. K. Choubey, A. Tripathi, P. Sharma, S. K. Shrivastava, *Bioorg. Med. Chem.* **2020**, *28*, 115721.



## INTELLIGENT TRANSPORTATION SYSTEMS AS A PIVOTAL INSTRUMENT IN THE DEVELOPMENT OF SMART CITIES IN THE 21<sup>st</sup> CENTURY

**Aniekan Essienubong Ikpe**

Department of Mechanical Engineering, Akwa Ibom State Polytechnic, Ikot Osurua, PMB. 1200, Nigeria.

ORCID ID: 0000-0001-9069-9676

**Jephtar Uviefowwe Ohwoekevwo**

Department of Production Engineering, University of Benin, Benin City, PMB. 1154, Nigeria

ORCID ID: 0009-0009-1763-1566

### ABSTRACT

The rapid urbanization and population growth witnessed in the 21<sup>st</sup> century have led to increased challenges in urban transportation. Congestion, pollution, and accidents have become major concerns for cities worldwide. To address these issues, smart cities are embracing Intelligent Transportation Systems (ITS) as a pivotal instrument in enhancing the efficiency, sustainability, and safety of urban transportation networks. By exploring various scholarly articles, reports, and case studies, this paper explored the types of ITS as well as its significance in smart cities, highlighted the key benefits of ITS in transforming urban mobility and explored the challenges and potential solutions associated with its implementation. The findings revealed that ITS leverage advanced high-tech to enhance the development of smart cities through the integration of various technologies, such as sensors, communication networks, and data analytics, to optimize transportation operations, as well as emergency response systems, allowing for faster and more efficient responses to accidents. It further indicated that utilizing real-time data from sensors and cameras, traffic management systems dynamically adjust signal timings, reroute vehicles, and provide accurate travel information to drivers. Moreover, advanced driver assistance systems, such as collision avoidance and lane departure warning systems, leverage ITS technologies to detect potential hazards and alert drivers. By providing first-hand information on public transit schedules, bike-sharing availability, and carpooling options, ITS motivate citizens to choose more sustainable modes of transportation. This shift reduces greenhouse gas (GHG) emissions, improves air quality, and promotes healthier urban environment. However, it was observed that the integration of various technologies and systems require significant investments in infrastructure and expertise. Hence, ensuring data privacy and cybersecurity is crucial to maintain public trust in these systems.

**Keywords:** Smart cities, Urban transportation, Accidents, safety, Healthier environment.

### 1. Transportation System

Transportation systems play a crucial role in the functioning of societies, enabling the movement of people, goods, and services. A transportation system refers to the infrastructure, policies, and procedures that facilitate the movement of individuals and goods from one location to another. It involves a network of physical infrastructure, such as roads, railways, airports, and ports, along with the associated policies and regulations that govern their uses (Adeniran and Yusuf, 2016). It encompasses various modes of transportation, including land, air, and water, and involves the coordination of multiple stakeholders, such as government



agencies, transportation companies, and users. The main principles of a transportation system are as follows:

- i. **Accessibility:** A fundamental principle of a transportation system is to provide accessibility to all individuals, regardless of their socioeconomic status, age, or physical abilities (Dixit and Sivakumar, 2020). This principle ensures that transportation services are available and affordable for everyone, promoting inclusivity and equal opportunities.
- ii. **Efficiency:** Efficiency is a key principle that emphasizes the optimal use of resources within a transportation system. It involves minimizing travel time, reducing congestion, and maximizing the capacity of transportation infrastructure (Chinbat et al., 2023). Efficient transportation systems contribute to economic growth, as they enable the smooth flow of goods and services.
- iii. **Safety:** Safety is of paramount importance in any transportation system. Measures must be in place to ensure the safety of passengers, drivers, and pedestrians. This includes implementing traffic regulations, maintaining infrastructure, and promoting safe driving practices (Joewono and Kubota, 2006). Safety measures help prevent accidents and minimize the impact of transportation on public health.
- iv. **Sustainability:** With growing concerns about environmental degradation and climate change, sustainability has become a crucial principle in transportation systems. Sustainable transportation aims to minimize the negative environmental impacts of transportation, such as greenhouse gas emissions and air pollution (Din et al., 2023). This can be achieved through the promotion of public transportation, the use of alternative fuels, and the adoption of eco-friendly technologies.
- v. **Integration:** Integration refers to the seamless coordination of different modes of transportation within a transportation system. It involves the development of intermodal connections, such as transit hubs and transfer points, to facilitate the smooth transfer of passengers and goods between different modes (Ibrahim, 2003). Integration enhances the efficiency and convenience of transportation, reducing travel time and improving overall accessibility.

A transportation system encompasses the physical infrastructure, policies, and procedures that enable the movement of people, goods, and services. Its key principles include accessibility, efficiency, safety, sustainability, and integration. By adhering to these principles, transportation systems can effectively meet the needs of individuals and contribute to the overall development of societies.

## **2. History of Intelligent Transportation Systems**

Intelligent Transportation Systems (ITS) have revolutionized the way we manage and operate transportation systems. These systems integrate advanced technologies to enhance the efficiency, safety, and sustainability of transportation networks (Singh and Gupta, 2015). The history of ITS can be traced back to the early 20th century when the first attempts were made to automate and improve transportation systems. One of the earliest developments in ITS can be attributed to the introduction of traffic signals in the 1920s (Garcia-Ortiz et al., 1995). These signals were manually operated and aimed to regulate traffic flow at intersections. However, it wasn't until the 1960s that the first computerized traffic control systems were implemented. These systems utilized sensors and algorithms to optimize traffic signal timings based on real-time traffic conditions. The 1970s witnessed significant advancements in ITS with the introduction of electronic toll collection systems (Ramadan and Kumar, 2022). These systems eliminated the need for manual toll collection, reducing congestion and improving overall



efficiency. Additionally, the 1970s saw the emergence of early traffic management centres, where operators could monitor and control traffic using closed-circuit television (CCTV) cameras. The 1980s marked a turning point in the history of ITS with the advent of advanced communication technologies. This decade saw the introduction of radio-based communication systems, enabling real-time data exchange between vehicles and infrastructure. These systems paved the way for the development of vehicle-to-infrastructure (V2I) and vehicle-to-vehicle (V2V) communication, which are integral components of modern ITS. In the 1990s, the focus of ITS shifted towards intelligent vehicle technologies. This decade witnessed the development of advanced driver assistance systems (ADAS) such as anti-lock braking systems (ABS) and adaptive cruise control (ACC). These technologies aimed to enhance vehicle safety and reduce accidents by providing automated assistance to drivers. The 21st century has seen rapid advancements in ITS, driven by the proliferation of information and communication technologies. The integration of GPS, wireless communication, and data analytics has enabled the development of sophisticated traffic management systems (Oladimeji et al., 2023). These systems can predict traffic patterns, optimize route planning, and provide real-time information to drivers, thereby improving overall transportation efficiency. In recent years, the concept of smart cities has gained prominence, with ITS playing a crucial role in their development. Smart cities leverage ITS technologies to create sustainable and liveable urban environments (Hui et al., 2023). For instance, intelligent traffic management systems can reduce congestion and emissions, while smart parking systems can optimize parking space utilization. The history of ITS is characterized by continuous advancements in technology and a shift towards intelligent and automated transportation systems. From the introduction of traffic signals to the development of smart cities, ITS has transformed the way we manage and operate transportation networks. As technology continues to evolve, the future of ITS holds immense potential for further enhancing transportation efficiency, safety, and sustainability.

### **3. Technological Advancement of Intelligent Transportation Systems**

Intelligent Transportation Systems (ITS) have revolutionized the way we travel and commute. These systems utilize advanced technologies to improve the efficiency, safety, and sustainability of transportation networks. Over the years, significant advancements have been made in the development of ITS, leading to a multitude of benefits for both individuals and society as a whole. One of the key technological advancements in ITS is the use of sensors and data collection devices. These devices are strategically placed throughout transportation networks to gather real-time data on traffic flow, road conditions, and weather patterns as shown in Figure 1. This data is then analysed and used to optimize traffic management, reduce congestion, and improve overall transportation efficiency (Yigitcanlar et al., 2024). For example, traffic signals equipped with sensors can adjust their timing based on the current traffic volume, leading to smoother traffic flow and reduced travel times. Another significant development in ITS is the integration of communication technologies. This allows vehicles, infrastructure, and traffic management systems to communicate with each other, enabling the exchange of critical information in real-time. For instance, vehicles equipped with connected technologies can receive alerts about accidents, road closures, or hazardous conditions, allowing drivers to make informed decisions and choose alternative routes. This integration of communication technologies enhances safety and reduces the likelihood of accidents (Martin et al., 2021). Furthermore, the advent of artificial intelligence (AI) and machine learning has greatly contributed to the advancement of ITS. AI algorithms can analyse vast amounts of data collected from various sources, such as sensors, cameras, and GPS devices, to predict traffic

patterns, identify potential bottlenecks, and optimize transportation operations. Machine learning algorithms can also be used to develop intelligent algorithms that can adapt and learn from real-time data, continuously improving the efficiency and effectiveness of transportation systems. The advancements in ITS have had a profound impact on various aspects of transportation (Stawiarska and Sobczak, 2018). Firstly, these technologies have significantly improved traffic management and reduced congestion. By utilizing real-time data and intelligent algorithms, traffic signals can be optimized, and traffic flow can be better managed, resulting in reduced travel times and improved overall efficiency.



Figure 1: Intelligent transportation system layout

Secondly, the integration of communication technologies has enhanced safety on the roads. Vehicles equipped with connected technologies can receive warnings about potential hazards, allowing drivers to take necessary precautions. Additionally, the ability of infrastructure and vehicles to communicate with each other enables the development of autonomous vehicles, which have the potential to further enhance safety and reduce accidents. Moreover, the advancements in ITS have also contributed to environmental sustainability (Wajeetongratana, 2023). By optimizing traffic flow and reducing congestion, these technologies help minimize fuel consumption and emissions. Additionally, the integration of electric vehicles and renewable energy sources into transportation networks further promotes sustainability and reduces the carbon footprint of transportation systems.

The technological development and advancement of intelligent transportation systems have revolutionized the way we travel and commute. Through the use of sensors, communication technologies, and artificial intelligence, these systems have significantly improved traffic management, enhanced safety, and promoted environmental sustainability. As technology continues to evolve, it is expected that intelligent transportation systems will play an even more significant role in shaping the future of transportation, making it more efficient, safe, and sustainable.





#### 4. Components of Intelligent Transportation Systems

This involves the integration of advanced technologies and communication systems into transportation infrastructure to enhance safety, efficiency, and sustainability. These systems consist of various components that work together to improve the overall transportation experience.

- i. **Traffic Management:** One of the fundamental components of ITS is traffic management. This involves the use of sensors, cameras, and other monitoring devices to collect real-time data on traffic flow, congestion, and incidents (Nigam et al., 2023). This information is then analysed and used to optimize traffic signal timings, manage lane closures, and provide accurate travel time information to drivers. By effectively managing traffic, ITS can reduce congestion, improve travel times, and enhance overall road safety.
- ii. **Transportation Infrastructure:** Another crucial component of ITS is transportation infrastructure. This includes the deployment of smart infrastructure elements such as intelligent traffic lights, variable message signs, and electronic toll collection systems (Oladimeji et al., 2023). These technologies enable real-time communication between vehicles and infrastructure, allowing for better coordination and control of traffic. For example, intelligent traffic lights can adjust their timings based on traffic conditions, reducing unnecessary stops and delays. Similarly, electronic toll collection systems eliminate the need for physical toll booths, improving traffic flow and reducing fuel consumption.
- iii. **Vehicle Technologies:** In addition to traffic management and infrastructure, ITS also encompasses vehicle technologies. This includes the integration of advanced features into vehicles, such as adaptive cruise control, lane departure warning systems, and collision avoidance systems. These technologies utilize sensors and communication systems to monitor the vehicle's surroundings and provide alerts or take corrective actions when necessary. By enhancing vehicle safety and reducing human errors, ITS can significantly reduce the number of accidents and fatalities on the roads (Upadhyay et al., 2023).
- iv. **Traveller Information Systems:** ITS also incorporate traveller information systems as a vital component. These systems provide real-time information to travellers, enabling them to make informed decisions about their routes and modes of transportation. Traveller information systems can include mobile applications, dynamic message signs, and websites that provide up-to-date information on traffic conditions, public transportation schedules, and alternative routes. By empowering travellers with accurate information, ITS can help them avoid congested areas, choose more sustainable modes of transportation, and make their journeys more efficient (Areche et al., 2023).

The integration and interoperability of these components are crucial for the success of ITS. The seamless exchange of data and communication between different systems and stakeholders is essential for achieving a truly intelligent transportation system. Standardization of protocols and interfaces ensures compatibility and interoperability, allowing for efficient data sharing and collaboration between various components. Intelligent Transportation Systems consist of several key components that work together to create a smarter and more efficient transportation system. These components include traffic management, transportation infrastructure, vehicle technologies, traveller information systems, and integration and interoperability. By leveraging advanced technologies and communication systems, ITS has the potential to revolutionize the way we travel, improving safety, efficiency, and sustainability in our transportation networks.

## 5. Types of Intelligent Transportation Systems

This involves several types, incorporating conventional technologies that aim to improve the overall transportation experience.

- i. **Advanced Traffic Management Systems (ATMS):** ATMS is a crucial component of ITS that focuses on managing and optimizing traffic flow. It utilizes real-time data from various sources such as sensors, cameras, and GPS to monitor traffic conditions and make informed decisions. ATMS can detect incidents, congestion, and accidents, allowing traffic operators to implement appropriate strategies to alleviate congestion and improve traffic flow. This system also enables the coordination of traffic signals, ramp metering, and dynamic message signs to provide real-time information to drivers. ATMS development strategies are presented in Figure 2.

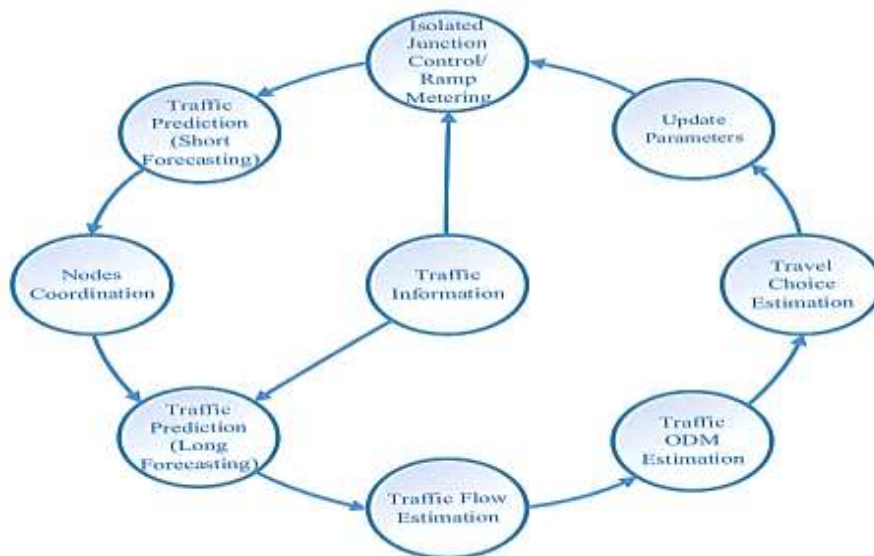

Figure 2: ATMS development strategy

- ii. **Advanced Traveller Information Systems (ATIS):** ATIS aims to provide travellers with accurate and timely information about traffic conditions, alternative routes, and travel times. This system utilizes various communication channels, including websites, mobile applications, and variable message signs, to disseminate information to drivers. By providing real-time updates, ATIS helps drivers make informed decisions, avoid congested areas, and choose the most efficient routes. This not only reduces travel time but also enhances safety by minimizing driver frustration and stress.
- iii. **Advanced Vehicle Control Systems (AVCS):** AVCS focuses on enhancing vehicle safety and efficiency through the integration of advanced technologies. This includes systems such as adaptive cruise control, lane departure warning, and collision avoidance systems. AVCS utilizes sensors, cameras, and communication systems to monitor the vehicle's surroundings and provide warnings or take control of the vehicle if necessary. These systems aim to reduce accidents, improve fuel efficiency, and enhance overall traffic safety.
- iv. **Commercial Vehicle Operations (CVO):** CVO systems are designed to improve the efficiency and safety of commercial vehicles, such as trucks and buses. These systems utilize technologies like electronic toll collection, weigh-in-motion systems, and fleet management systems to streamline operations and reduce delays. CVO systems also



- enable better monitoring of vehicle conditions, driver behaviour, and compliance with regulations, ensuring safer and more efficient commercial transportation.
- v. **Advanced Parking Management Systems (APMS):** APMS focuses on optimizing parking space utilization and reducing congestion in urban areas. This system utilizes sensors, cameras, and real-time data to provide information about available parking spaces to drivers. By guiding drivers to vacant parking spots, APMS reduces the time spent searching for parking, thus minimizing traffic congestion and emissions. Additionally, APMS can integrate with payment systems, allowing for seamless and convenient parking transactions.
  - vi. **Advanced Public Transport System (APTS):** APTS aims to improve the operation and reliability of public transport. This involves using real-time information to provide up-to-date information on the location and arrival times of buses and trains. APTS also features a smart billing system that allows passengers to pay for their ride with a smart card, mobile phone or other device. This eliminates the need for cash transactions while also making public transport more comfortable and convenient.
  - vii. **Connected and Autonomous Vehicles (CAVs):** These are one of the most interesting developments in the field of intelligent transportation systems. The vehicles adopts a range of advanced technologies such as GPS, sensors and wireless communications to enable vehicles to vehicle interaction and the wider transport network. This allows them to make instant decisions, curtailing the need for human intervention and increasing safety and ride comfort. In countries like the UK, connected and autonomous cars are currently being tested with the aim of making them widely available on roads as soon as possible.
  - viii. **Intelligent Freight Transport System (IFTS):** Enhancing the operation and effectiveness of freight transportation is the goal of the Intelligent Freight Transport System (IFTS). This involves making use of real-time data to enhance the movement of commodities, lessen traffic, and shorten wait times. The International Funds Transfer System (IFTS), for instance, can be utilized to enhance delivery schedules and routes, lower the number of automobiles on the road, and enhance air quality. In an effort to promote low-carbon transportation, the UK government is funding International Transport Services (IFTS).

Intelligent Transportation Systems encompass various applications and technologies that aim to improve safety, efficiency, and sustainability in transportation. Advanced Traffic Management Systems, Advanced Traveller Information Systems, Advanced Vehicle Control Systems, Commercial Vehicle Operations, and Advanced Parking Management Systems are some of the key types of ITS. These systems play a vital role in enhancing traffic flow, providing real-time information to travellers, improving vehicle safety, streamlining commercial operations, and optimizing parking space utilization. By embracing these technologies, transportation systems can become more intelligent, efficient, and sustainable.

## **6. Applications of Intelligent Transportation Systems in Smart Cities**

Intelligent Transportation Systems (ITS) have emerged as a crucial component in the development of smart cities. These systems utilize advanced technologies to enhance the efficiency, safety, and sustainability of transportation networks. By integrating various data sources and employing intelligent algorithms, ITS can optimize traffic flow, reduce congestion, and improve overall mobility. Applications of intelligent transportation systems in smart cities are as follows:

- i. **Traffic Signal Control:** One of the primary applications of ITS in smart cities is traffic signal control. By utilizing real-time data from sensors, cameras, and GPS devices, traffic management systems can monitor and analyse traffic patterns. This works by formulation of the best type of cycle length, split duration, offset, and phase sequence (see Figure 3) for each intersection of the network, for maximum efficiency of the road traffic network (Lee and Chiu, 2020). This information can then be used to optimize signal timings, reroute vehicles, and provide real-time traffic updates to drivers. As a result, congestion can be reduced, travel times can be minimized, and fuel consumption can be decreased, leading to a more sustainable transportation system.

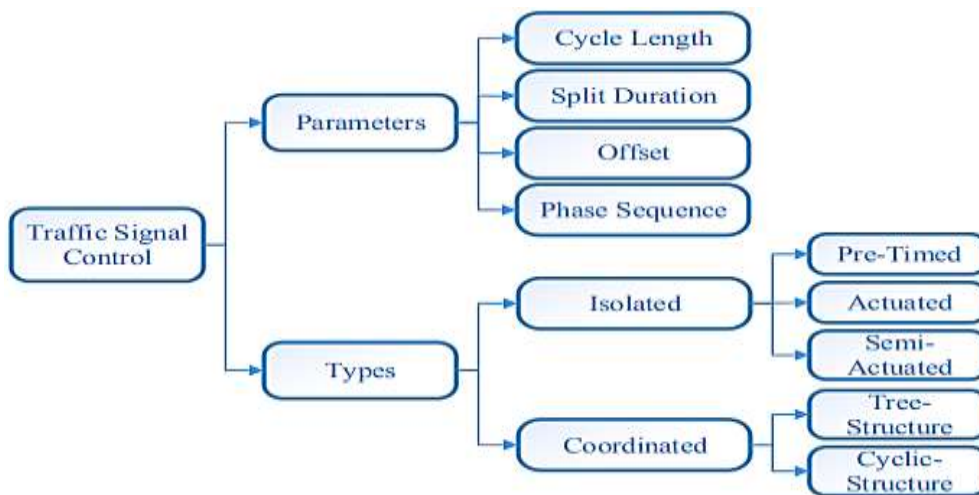

Figure 3: Traffic signal control

- ii. **Public Transportation Optimization:** Intelligent Transportation Systems can also play a significant role in optimizing public transportation services. By integrating data from various sources, such as bus schedules, passenger counts, and weather conditions, ITS can improve the efficiency and reliability of public transportation networks. For example, real-time tracking systems can provide accurate arrival times to passengers, reducing waiting times and enhancing the overall user experience. Additionally, ITS can optimize bus routes based on demand patterns, ensuring that resources are allocated efficiently (Gkiotsalitis, 2023)
- iii. **Smart Parking Solutions:** Parking is a major challenge in urban areas, leading to increased congestion and pollution. ITS can address this issue by providing smart parking solutions (Al-Turjman and Malekloo, 2019). By utilizing sensors and data analytics, ITS can detect available parking spaces and guide drivers to the nearest vacant spot. This not only reduces the time spent searching for parking but also minimizes traffic congestion caused by circling vehicles. Furthermore, smart parking systems can enable dynamic pricing, encouraging drivers to park in less congested areas or during off-peak hours. Smart parking system layout is shown in Figure 4.

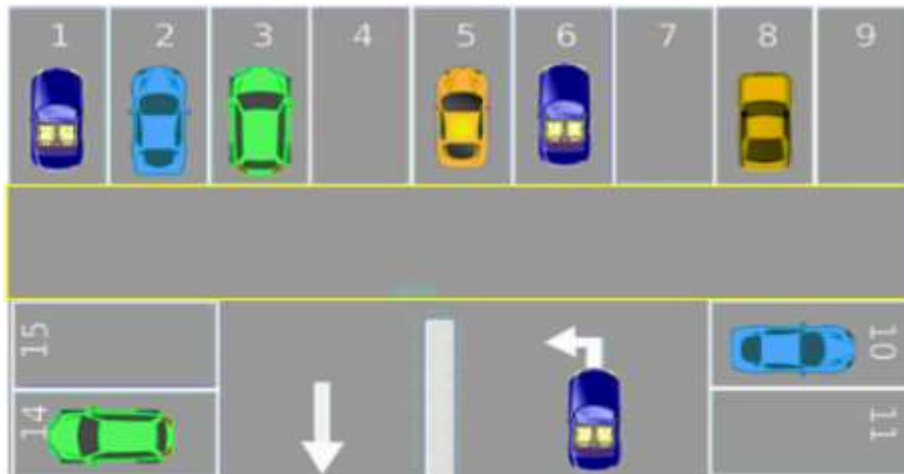

Figure 4: Smart parking system layout

- iv. **Enhanced Safety and Security:** Intelligent Transportation Systems can significantly enhance safety and security in smart cities. Through the integration of surveillance cameras, sensors, and advanced analytics, ITS can detect and respond to potential hazards in real-time (Javed et al., 2016). For instance, systems can identify accidents, traffic violations, or suspicious activities and alert authorities immediately. Additionally, ITS can facilitate emergency response by providing accurate location information and optimizing routes for emergency vehicles, ensuring timely assistance.

Intelligent Transportation Systems have immense potential in transforming transportation networks in smart cities. By leveraging advanced technologies and data analytics, these systems can optimize traffic flow, improve public transportation services, alleviate parking issues, and enhance safety and security. The integration of ITS in smart cities can lead to more efficient, sustainable, and user-friendly transportation systems. As cities continue to grow and face increasing mobility challenges, the adoption of ITS becomes crucial for creating smarter and more liveable urban environments.

## 7. Elements of Intelligent Transportation Systems

Intelligent Transportation Systems (ITS) encompass a wide range of technologies and strategies aimed at improving the efficiency, safety, and sustainability of transportation systems. These systems rely on the integration of various elements to achieve their objectives. The key elements of ITS and their importance in modern transportation systems are as follows:

- i. One of the fundamental elements of ITS is the use of advanced communication technologies. These technologies enable real-time data collection, analysis, and dissemination, allowing for better decision-making and coordination of transportation activities (Guerrero-Ibáñez et al., 2018). For example, vehicle-to-vehicle (V2V) and vehicle-to-infrastructure (V2I) communication systems enable vehicles to exchange information with each other and with the surrounding infrastructure, such as traffic signals and road sensors. This information can be used to optimize traffic flow, reduce congestion, and enhance safety.
- ii. Another crucial element of ITS is the integration of intelligent transportation management systems. These systems utilize advanced algorithms and models to monitor and control various aspects of transportation, including traffic flow, signal timing, and incident management. By analysing real-time data and predicting future conditions, these systems can dynamically adjust traffic signal timings, reroute

- vehicles, and provide real-time information to travellers (Kadłubek et al., 2022). This integration allows for more efficient use of existing infrastructure and resources, leading to reduced travel times and improved overall system performance.
- iii. ITS relies on the deployment of intelligent vehicles equipped with advanced sensors, processors, and actuators. These vehicles can autonomously perform various tasks, such as adaptive cruise control, lane keeping, and collision avoidance. By leveraging these technologies, ITS aims to enhance safety, reduce human errors, and improve the overall efficiency of transportation systems. Additionally, intelligent vehicles can communicate with each other and with the infrastructure, enabling cooperative manoeuvres and further enhancing safety and efficiency (Barodi et al., 2023).
  - iv. The availability and accessibility of accurate and up-to-date information are also critical elements of ITS. Travelers need timely information about traffic conditions, alternative routes, and public transportation options to make informed decisions (Zulkarnain and Putri, 2021). ITS provides various means of disseminating this information, including dynamic message signs, mobile applications, and websites. By empowering travellers with real-time information, ITS can help them make more efficient travel choices, leading to reduced congestion and improved overall system performance.

The elements of Intelligent Transportation Systems, including advanced communication technologies, intelligent transportation management systems, intelligent vehicles, and the availability of accurate information, are crucial for improving the efficiency, safety, and sustainability of transportation systems. These elements constitute a cooperative system (see Figure 5) of transportation which work together to optimize traffic flow, reduce congestion, enhance safety, and provide travellers with real-time information. As transportation systems continue to evolve, the integration of these elements will play a vital role in shaping the future of transportation.



Figure 5: Cooperative intelligent transportation system

### 8. Advantages of Intelligent Transportation Systems in Smart Cities

Intelligent Transportation Systems (ITS) have emerged as a crucial instrument for the development of smart cities. With the rapid urbanization and increasing population, cities face numerous challenges related to traffic congestion, pollution, and inefficient transportation systems (Xiong et al., 2012). ITS, incorporating advanced technologies and data-driven solutions, offer promising opportunities to address these challenges and transform urban mobility. They have emerged as a crucial component of smart cities, offering numerous



benefits to urban areas. By integrating advanced technologies and data-driven solutions, ITS aims to enhance the efficiency, safety, and sustainability of transportation systems. The implementation of ITS in smart cities has several benefits such as enhanced transportation efficiency, reduce environmental impact, and improve the overall quality of life for citizens. The advantages of implementing ITS in smart cities are manifold, including improved traffic management, reduced congestion, enhanced safety, and increased environmental sustainability as follows:

- i. **Improved Traffic Management:** One of the primary advantages of ITS in smart cities is the ability to optimize traffic management. Through the use of real-time data collection and analysis, ITS enables authorities to monitor traffic patterns, identify congestion hotspots, and implement effective strategies to alleviate traffic flow. For instance, adaptive traffic signal control systems can adjust signal timings based on real-time traffic conditions, reducing delays and improving overall traffic efficiency. This leads to shorter travel times, increased productivity, and improved quality of life for residents.
- ii. **Reduced Congestion:** Intelligent Transportation Systems play a crucial role in reducing congestion in smart cities. By providing real-time traffic information to drivers, ITS enables them to make informed decisions about their routes, avoiding congested areas and choosing alternative paths (Saleem et al., 2022). This not only reduces travel time but also minimizes the environmental impact of traffic congestion, such as air pollution and fuel consumption. Additionally, ITS can facilitate the integration of different modes of transportation, such as public transit and ride-sharing services, further reducing the number of private vehicles on the road. They ensure equal access to essential services, such as healthcare, education, and employment opportunities. ITS improves connectivity, reduces social disparities by connecting remote areas to urban centres, promoting inclusivity. Improved connectivity reduces social disparities by connecting remote areas to urban centres, promoting inclusivity
- iii. **Enhanced Safety:** Another significant advantage of implementing ITS in smart cities is the improvement in road safety (Musa et al., 2023). ITS technologies, such as intelligent speed adaptation and collision warning systems, help prevent accidents by providing real-time alerts and warnings to drivers. Moreover, ITS enables authorities to monitor and manage traffic violations more effectively, leading to better enforcement of traffic rules and regulations. This results in a safer transportation environment for both drivers and pedestrians, reducing the number of accidents and fatalities. By utilizing technologies such as vehicle-to-vehicle (V2V) and vehicle-to-infrastructure (V2I) communication, ITS enables the exchange of critical safety information. For instance, vehicles can alert each other about potential hazards, such as sudden braking or lane changes. Additionally, ITS facilitates the implementation of intelligent speed adaptation systems, which adjust vehicle speeds based on road conditions, reducing the likelihood of accidents.
- iv. **Optimized Traffic Management:** One of the primary advantages of ITS in smart cities is the ability to optimize traffic management. By collecting real-time data from various sources, such as traffic cameras detection (see Figure 6), GPS devices, and weather sensors, cities can analyse and predict traffic patterns (Filho et al., 2020). This information allows for the implementation of dynamic traffic signal control systems, which adjust signal timings based on current traffic conditions. Consequently, this reduces congestion, improves travel times, and enhances overall traffic flow efficiency. ITS ensures equal access to essential services, such as healthcare, education, and employment opportunities



Figure 6: Traffic camera detection

- v. **Increased Environmental Sustainability:** Intelligent Transportation Systems contribute to the environmental sustainability of smart cities. By optimizing traffic flow and reducing congestion, ITS helps minimize fuel consumption and greenhouse gas emissions. Additionally, ITS can support the integration of electric vehicles and promote the use of alternative modes of transportation, such as cycling and walking. These measures contribute to a cleaner and greener urban environment, reducing the carbon footprint of transportation systems. Also, encouraging modal shift from road to rail or water transport minimizes the ecological footprint of transportation activities. Furthermore, efficient transportation systems optimize resource utilization, reducing energy consumption and waste (Anwar and Oakil, 2024). They encourage the use of sustainable modes, such as public transport, cycling, and walking, reducing reliance on private vehicles.
- vi. **Enhanced Transportation Efficiency:** Another key benefit of ITS is its ability to enhance transportation efficiency. By utilizing real-time data collection and analysis, ITS enables traffic management authorities to monitor and control traffic flow effectively (Adeleke et al., 2016). Intelligent traffic signal systems, for instance, can adjust signal timings based on traffic conditions, reducing congestion and improving traffic flow. Additionally, ITS can provide accurate and timely information to drivers, enabling them to make informed decisions about route choices and travel times. This not only reduces travel time but also minimizes fuel consumption and emissions, leading to a more sustainable transportation system.
- vii. **Integration of Different Transportation Modes:** ITS enables the integration of different modes of transportation, promoting multimodal connectivity. Through the use of mobile applications and smart devices, travellers can access real-time information about public transportation schedules, bike-sharing availability, and parking options (Elkosantini and Darmoul, 2013). This integration encourages the use of sustainable modes of transportation, reduces reliance on private vehicles, and contributes to a greener environment.
- viii. **Reduced Environmental Impact:** The implementation of ITS in smart cities can also contribute to reducing the environmental impact of transportation. By optimizing traffic flow and reducing congestion, ITS helps to minimize vehicle idling time, which is a significant source of air pollution. Furthermore, ITS can facilitate the integration of electric vehicles (EVs) into the transportation network (Lv and Shang, 2023). Through the deployment of charging infrastructure and intelligent routing systems, ITS can support the widespread adoption of EVs, leading to a significant reduction in greenhouse gas emissions. Additionally, ITS can promote the use of alternative modes





of transportation, such as public transit and cycling, by providing real-time information and seamless integration between different modes. This multimodal approach can further reduce the reliance on private vehicles and promote sustainable transportation options. They also promote the use of alternative fuels and electric vehicles which helps in mitigating the environmental impact of transportation

- ix. **Improved Quality of Life:** The implementation of ITS in smart cities has the potential to improve the overall quality of life for citizens. By reducing traffic congestion and travel times, ITS can enhance accessibility and connectivity within the city. This enables individuals to reach their destinations more efficiently, leading to increased productivity and reduced stress levels. Moreover, ITS can enhance the safety of transportation systems by providing real-time information about road conditions, accidents, and hazards (Wang and Zhou, 2023). This allows authorities to respond promptly and effectively, minimizing the risk of accidents and improving overall road safety. Additionally, ITS can support the development of smart parking systems, reducing the time spent searching for parking spaces and alleviating parking-related issues in urban areas. Shared transportation modes promote sustainable mobility, reducing congestion and environmental pollution. ITS promotes social interactions, fostering a sense of community and belonging.
- x. **Economic Growth:** Facilitates trade and commerce by enhancing the movement of goods and services across regions, fostering economic growth. ITS improves connectivity, reduces transportation costs, making products more affordable for consumers (Okechukwu et al., 2020). It brings about efficient logistics and supply chains which enhances productivity and competitiveness in the global market. A well-functioning transportation system creates employment opportunities in various sectors, such as logistics, infrastructure development, and maintenance. Additionally, investments in transportation infrastructure stimulate economic activity, attracting businesses and promoting regional development.

The advantages of implementing Intelligent Transportation Systems in smart cities are numerous and significant. From improved traffic management and reduced congestion to enhanced safety and increased environmental sustainability, ITS offers a range of benefits that contribute to the overall efficiency and liveability of urban areas. By harnessing advanced technologies and data-driven solutions, smart cities can leverage ITS to create a more efficient, safe, and sustainable transportation system for their residents. By leveraging advanced technologies and data-driven solutions, ITS can significantly enhance transportation efficiency, reduce environmental impact, and improve the overall quality of life for citizens. The implementation of ITS in smart cities requires collaboration between government authorities, transportation agencies, and technology providers. It is crucial to invest in the necessary infrastructure, data collection systems, and communication networks to fully realize the potential of ITS. As cities continue to grow and face transportation challenges, ITS offers a promising solution to create sustainable, efficient, and liveable urban environments.

## **9. Disadvantages of Intelligent Transportation Systems**

Intelligent Transportation Systems (ITS) utilize advanced technologies to improve the efficiency, safety, and sustainability of transportation networks. However, despite their numerous advantages, ITS also come with certain drawbacks that need to be considered. The disadvantages of intelligent transportation systems and the potential challenges they pose are enumerated as follows:



- i. **Cost:** Implementing intelligent transportation systems requires significant financial investments. The installation and maintenance of infrastructure, such as sensors, cameras, data analytics platforms, and communication networks, can be very expensive (Bayen and Shankar, 2017). Additionally, the cost of developing and maintaining the software and hardware components of ITS can be substantial. These expenses may pose a challenge, particularly for developing countries or regions with limited financial resources. Also, regular maintenance and updates are required to ensure the system's effectiveness. Therefore, securing sufficient funding and establishing sustainable financial models are essential for the successful deployment of ITS in smart cities.
- ii. **Privacy Concerns:** Intelligent transportation systems heavily rely on data collection and analysis. This raises concerns about the privacy of individuals using the transportation network (Hahn et al., 2021). The collection of personal data, such as location information and travel patterns, can potentially be misused or compromised. Ensuring the security and privacy of this data is crucial to prevent unauthorized access or misuse, which requires robust cybersecurity measures and strict regulations.
- iii. **Technological Dependence:** Intelligent transportation systems are highly dependent on technology, including sensors, communication networks, and software algorithms. Any disruption or failure in these technological components can lead to system malfunctions or breakdowns (Maimaris and Papageorgiou, 2016). This dependence on technology makes ITS vulnerable to cyber-attacks, system failures, or even natural disasters. Ensuring the reliability and resilience of these systems is essential to prevent potential disruptions in transportation networks.
- iv. **Limited Accessibility:** While intelligent transportation systems aim to improve transportation efficiency, they may inadvertently create barriers for certain segments of the population (Susanty et al., 2021). For example, individuals who do not have access to smartphones or other smart devices may face difficulties in utilizing ITS services. This can result in a digital divide, where certain groups are excluded from the benefits of these systems. Ensuring equitable access to ITS services is crucial to avoid exacerbating existing social inequalities.
- v. **Data Privacy and Security:** One concern is the issue of data privacy and security. As ITS relies heavily on collecting and analysing vast amounts of data, there is a risk of unauthorized access or misuse of personal information. Therefore, it is crucial for smart cities to implement robust cybersecurity measures and ensure that data is anonymized and protected (Paul et al., 2023).
- vi. **Workforce Displacement:** The automation and optimization of transportation processes through intelligent transportation systems may lead to workforce displacement. As certain tasks become automated, the need for human intervention may decrease, potentially leading to job losses in the transportation sector (Thejaas, 2023). This can have significant socio-economic implications, particularly for individuals whose livelihoods depend on traditional transportation-related jobs. Adequate measures should be taken to address this potential drawback, such as retraining programs or the creation of new job opportunities within the ITS sector.

## 10. Summary

Intelligent transportation systems offer numerous benefits, including improved efficiency, safety, and sustainability. However, it is important to acknowledge and address the potential disadvantages they bring. The cost of implementation, privacy concerns, technological dependence, limited accessibility, and workforce displacement are some of the key drawbacks



associated with ITS. By understanding and mitigating these challenges, policymakers and stakeholders can ensure that intelligent transportation systems are implemented in a manner that maximizes their benefits while minimizing their drawbacks.

Intelligent Transportation Systems (ITS) have emerged as a crucial component in the development of smart cities. These systems utilize advanced technologies to enhance the efficiency, safety, and sustainability of transportation networks. The implementation of ITS in smart cities has proven to be highly beneficial. Firstly, these systems improve traffic management by utilizing real-time data and advanced algorithms to optimize traffic flow. This leads to reduced congestion, shorter travel times, and improved overall transportation efficiency. Additionally, ITS enables the integration of various modes of transportation, such as public transit, ride-sharing services, and cycling, into a seamless network. This multimodal approach encourages sustainable transportation choices and reduces reliance on private vehicles, thereby mitigating traffic congestion and reducing carbon emissions.

Furthermore, ITS plays a crucial role in enhancing the safety of transportation systems. Through the use of sensors, cameras, and communication technologies, these systems can detect and respond to potential hazards in real-time. For instance, they can alert drivers about accidents, road conditions, or other emergencies, allowing them to take appropriate actions. This proactive approach significantly reduces the risk of accidents and improves overall road safety. Moreover, ITS contributes to the overall sustainability of smart cities. By optimizing traffic flow and reducing congestion, these systems help minimize fuel consumption and air pollution. Additionally, the integration of electric vehicles (EVs) into ITS networks promotes the adoption of clean energy solutions, further reducing greenhouse gas emissions. Furthermore, ITS enables efficient parking management, reducing the time spent searching for parking spaces and consequently decreasing traffic congestion and emissions.

## 11. Conclusion and Recommendations

Intelligent Transportation Systems have the potential to revolutionize transportation in smart cities, and are a vital driver for the development of smart cities. These systems enhance transportation efficiency, improve safety, and contribute to sustainability. By utilizing real-time data, advanced algorithms, and innovative technologies, ITS optimizes traffic flow, integrates various modes of transportation, and enhances overall transportation management. The implementation of ITS in smart cities leads to reduced congestion, shorter travel times, improved safety, and reduced environmental impact. By integrating ITS with existing infrastructure, embracing data-driven decision making, prioritizing connectivity and communication, fostering public-private partnerships, and prioritizing cybersecurity, smart cities can fully harness the benefits of these systems. Implementing these recommendations will lead to enhanced transportation efficiency, reduced congestion, improved safety, and a more sustainable urban environment. Therefore, it is imperative for cities to invest in and prioritize the deployment of ITS to create smarter, more efficient, and sustainable urban environments. Also, it is essential for city authorities, policymakers, and stakeholders to collaborate and invest in intelligent transportation systems to drive the development of smart cities. As smart cities continue to evolve, it is imperative to explore the potential of ITS and provide recommendations for their effective implementation which are as follows:

- i. Integration of ITS with existing infrastructure: To fully leverage the benefits of ITS, it is essential to integrate these systems with the existing transportation infrastructure. This integration should be seamless and ensure interoperability between different components of the transportation network. By integrating ITS with existing



- infrastructure, cities can optimize the use of resources, reduce congestion, and enhance overall transportation efficiency.
- ii. Embrace data-driven decision making: Intelligent transportation systems generate vast amounts of data that can be utilized to make informed decisions. Smart cities should embrace data-driven decision making by leveraging the data collected through ITS. This data can provide valuable insights into traffic patterns, congestion hotspots, and transportation demand. By analysing this data, city authorities can optimize traffic flow, improve public transportation services, and enhance overall mobility within the city.
  - iii. Prioritize connectivity and communication: To ensure the seamless functioning of ITS, it is crucial to prioritize connectivity and communication infrastructure. Smart cities should invest in robust communication networks that can support the exchange of real-time data between different components of the transportation system. This will enable efficient traffic management, timely incident response, and effective coordination between various stakeholders involved in the transportation ecosystem.
  - iv. Foster public-private partnerships: The successful implementation of intelligent transportation systems requires collaboration between public and private entities. Smart cities should foster public-private partnerships to leverage the expertise and resources of both sectors. Public-private partnerships can facilitate the development and deployment of innovative ITS solutions, ensuring their scalability and sustainability. Additionally, these partnerships can help in securing funding for large-scale ITS projects, reducing the burden on public budgets.
  - v. Prioritize cybersecurity: As ITS rely heavily on interconnected systems and data exchange, ensuring cybersecurity is of utmost importance. Smart cities should prioritize cybersecurity measures to protect the integrity and privacy of transportation data. Robust security protocols, encryption techniques, and regular audits should be implemented to safeguard against cyber threats. Additionally, awareness campaigns and training programs should be conducted to educate users about potential risks and best practices for cybersecurity.

## References

- Adeniran, A. O., Yusuf, T. B. (2016) Transportation and National Development: Emphasis to Nigeria. *Developing Country Studies*, 6(9), 93-104.
- Dixit, M. and Sivakumar, A. (2020) Capturing the impact of individual characteristics on transport accessibility and equity analysis. *Transportation Research Part D: Transport and Environment*, 87, 102473.
- Chinbat, T., Fumihiko, N., Mihoko, M., Shinji, T. and Ryo, A. (2023) Impact assessment study of mobility-as-a-service (MaaS) on social equity through nonwork accessibility in rural Japan. *Asian Transport Studies*, 9, 100109.
- Joewono, T. B. and Kubota, H. (2006) Safety and Security Improvement in Public Transportation Based on Public Perception in Developing Countries. *IATSS Research*, 30(1), 86-100.
- Din, A. U., Ur Rahman, I., Vega-Muñoz, A., Elahi, E., Salazar-Sepúlveda, G., Contreras-Barraza, N. and Alhrahshah, R. R. (2023) How Sustainable Transportation Can Utilize Climate Change Technologies to Mitigate Climate Change. *Sustainability*, 15, 9710.



- Ibrahim, M. F. (2003) Improvements and integration of a public transport system: the case of Singapore. *Cities*, 20(3), 205-216.
- Singh, B. and Gupta, A. (2015) Recent trends in intelligent transportation systems: a review. *Journal of Transport Literature*, 9(2), 30-34.
- Garcia-Ortiz, A., Amin, S. M. And Wootton, J. R. (1995) Intelligent Transportation Systems Enabling Technologies. *Mathematical and Computer Modelling*, 22(4-7), 11-81.
- Ramadan, O. K. and Kumar, S. R. (2022) An Overview of Intelligent Transportation Systems In India. *International Research Journal of Modernization in Engineering Technology and Science*, 4(8), 2059-2065.
- Oladimeji, D., Gupta, K., Kose, N. A., Gundogan, K., Ge, L. and Liang, F. (2023) Smart Transportation: An Overview of Technologies and Applications. *Sensors*, 23(8), 3880.
- Hui, C. X., Dan, G., Alamri, S. and Toghraie, D. (2023) Greening smart cities: An investigation of the integration of urban natural resources and smart city technologies for promoting environmental sustainability. *Sustainable Cities and Society*, 99, 104985.
- Yigitcanlar, T., Downie, A. T., Mathews, S., Fatima, S., MacPherson, J., Behara, K. N. and Paz, A. (2024) Digital technologies of transportation-related communication: Review and the state-of-the-art. *Transportation Research Interdisciplinary Perspectives*, 23, 100987.
- Martin, H., Reck, D. J. and Raubal, M. (2021) Using information and communication technologies to facilitate mobility behaviour change and enable mobility as a service. *GI\_FORUM - Journal for Geographic Information Science*, 9(1), 187-193.
- Stawiarska, E. and Sobczak, P. (2018) The Impact of Intelligent Transportation System Implementations on the Sustainable Growth of Passenger Transport in EU Regions. *Sustainability*, 10(5), 1318.
- Wajeetongratana, S. (2023) Environmental benefits of intelligent transport systems implementing. *E3S Web of Conferences* 389, 05003.
- Nigam, N., Singh, D. P., Choudhary, J. (2023) A Review of Different Components of the Intelligent Traffic Management System (ITMS). *Symmetry*, 15, 583.
- Upadhyay, R.K., Sharma, S.K., Kumar, V., Valera, H. (2023) Introduction to Transportation Systems Technology and Integrated Management. In: Upadhyay, R. K., Sharma, S. K., Kumar, V., Valera, H. (eds) *Transportation Systems Technology and Integrated Management*. Energy, Environment, and Sustainability. Springer, Singapore.
- Areche, F. O., Ibanga, I. J. and Bamidele, O. (2023) A Discussion on Finding the Opportunity of Intelligent Transportation Systems (ITS) Implementation in Peru Based on Economics. *Engineering Science Letter*, 2(2), 41-46.
- Lee, W. H. and Chiu, C. Y. (2020) Design and Implementation of a Smart Traffic Signal Control System for Smart City Applications. *Sensors*, 20(2), 508.
- Gkiotsalitis, K. (2023) *Public Transport Optimization*. Springer Cham, Switzerland AG. ISBN: 978-3-031-12444-0.
- Al-Turjman, F. and Malekloo, A. (2019) Smart parking in IoT-enabled cities: A survey. *Sustainable Cities and Society*, 49, 101608.
- Javed, M. A., Ben Hamida, E. and Znaidi, W. (2016) Security in Intelligent Transport Systems for Smart Cities: From Theory to Practice. *Sensors*, 16, 879.
- Guerrero-Ibáñez, J., Zeadally, S. and Contreras-Castillo J. (2018) Sensor Technologies for Intelligent Transportation Systems. *Sensors (Basel)*, 18(4), 1212.



- Kadłubek, M., Thalassinos, E., Domagała, J., Grabowska, S. and Saniuk, S. (2022) Intelligent Transportation System Applications and Logistics Resources for Logistics Customer Service in Road Freight Transport Enterprises. *Energies*, 15(13), 4668.
- Barodi, A., Zemmouri, A., Bajit, A., Benbrahim, M. and Tamtaoui, A. (2023) Intelligent Transportation System Based on Smart Soft-Sensors to Analyse Road Traffic and Assist Driver Behaviour Applicable to Smart Cities. *Microprocessors and Microsystems*, 100, 104830.
- Zulkarnain, E. and Putri, T. D. (2021) intelligent transportation systems (ITS): A systematic review using a Natural Language Processing (NLP) approach. *Heliyon*, 7(12), e08615.
- Xiong, Z., Sheng, H., Rong, W. and Cooper, D. E. (2012) Intelligent transportation systems for smart cities: a progress review. *Science China Information Sciences*, 55, 2908-2914.
- Saleem, M., Abbas, S., Ghazal, T. M., Khan, M. A., Sahawneh, N. and Ahmad, M. (2022) Smart cities: Fusion-based intelligent traffic congestion control system for vehicular networks using machine learning techniques. *Egyptian Informatics Journal*, 23(3), 417-426.
- Musa, A. A., Malami, S. I., Alanazi, F., Ounaies, W., Alshammari, M., Haruna, S. I. (2023) Sustainable Traffic Management for Smart Cities Using Internet-of-Things-Oriented Intelligent Transportation Systems (ITS): Challenges and Recommendations. *Sustainability*, 15(13), 9859
- Filho, G. P., Meneguette, R. I., Torres Neto, J. R., Valejo, A., Weigang, L., Ueyama, J., Pessin, G. and Villas, L. A. (2020) Enhancing intelligence in traffic management systems to aid in vehicle traffic congestion problems in smart cities. *Ad Hoc Networks*, 107, 102265.
- Anwar, A. H. and Oakil, A. T. (2024) Smart Transportation Systems in Smart Cities: Practices, Challenges, and Opportunities for Saudi Cities. In: Belaïd, F., Arora, A. (eds) *Smart Cities. Studies in Energy, Resource and Environmental Economics*. Springer, Cham, Switzerland.
- Adeleke, O. O., Jimoh, Y. A., Yusuf, I. T., Kolo, S. S. Jimoh, O. D. Anwar, A. R., Abdulrahman, H. S. and Oyewobi, S. (2016) Research Efforts on Intelligent Transportation System in Nigeria: Development of Trip Planning Models. *Nigerian Journal of Technology*, 35(3), 491-502.
- Elkosantini, S. and Darmoul, S. (2013) Intelligent Public Transportation Systems: A review of architectures and enabling technologies. 2013 International Conference on Advanced Logistics and Transport, Sousse, Tunisia, 233-238.
- Lv, Z. and Shang, W. (2023) Impacts of intelligent transportation systems on energy conservation and emission reduction of transport systems: A comprehensive review. *Green Technologies and Sustainability*, 1(1), 100002.
- Wang, M. and Zhou, T. (2023) Does smart city implementation improve the subjective quality of life? Evidence from China. *Technology in Society*, 72, 102161.
- Okechukwu, E. E., Madonsela, N. S. and Adetunla, A. (2020) The Effect of Transportation Infrastructure on Economic Development. *Proceedings of the 2nd African International Conference on Industrial Engineering and Operations Management*, Harare, Zimbabwe, December 7-10, 2020.
- Bayen, A. M. and Shankar, S. (2017) *Intelligent Transportation Systems and Infrastructure: A Series of Briefs for Smart Investments*. University of California, Berkeley, California.
- Hahn, D., Munir, A. and Behzadan, V. (2021) Security and Privacy Issues in Intelligent Transportation Systems: Classification and Challenges. *IEEE Intelligent Transportation Systems Magazine*, 13(1), 181-196.
- Maimaris, A. and Papageorgiou, G. (2016) A review of Intelligent Transportation Systems from a communications technology perspective. 2016 IEEE 19th International Conference on Intelligent Transportation Systems (ITSC), Rio de Janeiro, Brazil, 54-59.
- Susanty, A., Purwanggono, B. and Putri, V. A. (2021) The barriers to the implementation of intelligent transportation system at Semarang City. *Procedia Computer Science*, 191, 312-319.



ATLAS 11. INTERNATIONAL  
CONGRESS ON ADVANCED SCIENTIFIC STUDIES AND INTERDISCIPLINARY RESEARCH

---

Paul, M., Maglaras, L., Ferrag, M. A. and Almomani, I. (2023) Digitization of healthcare sector: A study on privacy and security concerns. *ICT Express*, 9(4), 571-588.

Thejaas, B. (2023) Analyzing the Impact of Automation on Employment in Different Us Regions: A Data-Driven Approach. California State University, San Bernardino, *Electronic Theses, Projects, and Dissertations*, 1738.



**FARKLI SOĞUTUCU AKIŞKANLARIN KANATLI BORULU BİR KONDENSER KAPASİTESİNE ETKİLERİNİN UNILAB COILS YAZILIMI İLE İNCELENMESİ**  
INVESTIGATION OF THE EFFECTS OF DIFFERENT REFRIGERANTS ON THE CAPACITY OF A FINNED-TUBE CONDENSER USING UNILAB COILS SOFTWARE

**Kerim İŞLER**

Buzçelik Termik Cihazlar Sanayi Anonim Şirketi  
ORCID ID: 0009-0008-8065-4974

**Eser Burak GEZEN**

Buzçelik Termik Cihazlar Sanayi Anonim Şirketi  
ORCID NO: 0009-0007-8970-8230

**Mete KALYONCU**

Prof. Dr., Konya Teknik Üniversitesi  
ORCID ID: 0000-0002-2214-7631

**ÖZET**

Bu çalışmada, soğutma sistemlerinde birbirlerine alternatif olarak kullanılan farklı soğutucu akışkanların (R404A, R410A, R407C, R449A, R32, R1234ZE) hava soğutmalı bir kondenserin kapasitesine olan etkileri incelenmiştir. Soğutucu akışkanların ozon tabakasını tahrip etmesinden dolayı soğutma sistemlerinde her geçen gün farklı soğutucu akışkanların kullanımı gündeme gelmektedir. Bu durum ise kondenser kapasitelerini etkilemekte ve soğutma sistemlerinin tasarımında bu hususun dikkate alınmasını doğal olarak zorunlu kılmaktadır. Bu çalışmada, kondenzasyon sıcaklığı sabit (45 °C) tutularak farklı soğutucu akışkanlar kullanılması durumunda ele alınan kanatlı borulu bir kondenserin kapasitesinin nasıl değiştiği farklı dış ortam sıcaklık değerleri için hesaplanmış ve birbirleri ile karşılaştırılmıştır. Hesaplamalar Unilab Coils yazılımı kullanılarak yapılmıştır. Elde edilen sonuçlar tablolar halinde verilmiş ve grafikler ile sunulmuştur.

**Anahtar Kelimeler:** Soğutucu akışkan, Kondenser, Kapasite, R404A, R410A, R407C, R449A, R32, R1234ZE.





## ABSTRACT

In this study, the effects of different refrigerants (R404A, R410A, R407C, R449A, R32, R1234ZE) used as alternatives in cooling systems on the capacity of a air-cooled condenser were investigated. Since refrigerants destroy the ozone layer, the use of different refrigerants in cooling systems comes to the fore every day. This situation affects the condenser capacities and naturally requires this issue to be taken into consideration in the design of cooling systems. In this study, how the capacity of a finned-tube condenser changes when different refrigerants are used while keeping the condensation temperature constant (45 °C) was calculated for different ambient temperature values and compared with each other. Calculations are made using Unilab Coils software. The results obtained are given in tables and presented with graphs.

**Keywords:** Refrigerant, Condenser, Capacity, R404A, R410A, R407C, R449A, R32, R1234ZE.



## KÜRESELLEŞME ÇAĞINDA MEDENİYETLER ARASI İLİŞKİLERDE HOŞGÖRÜ ORTAMININ OLUŞMASI VE GELİŞMESİ SORUNLARI

TOLERANCE IN RELATIONS BETWEEN CIVILIZATIONS IN THE AGE OF  
GLOBALIZATION PROBLEMS OF THE FORMATION AND DEVELOPMENT OF THE  
ENVIRONMENT

**Dr. Ceyhun ŞAKIROĞLU**

Azerbaycan Ulusal Bilim Akademisi

Doğu Araştırmaları Enstitüsü'nün

"Doğu-Batı" şubesinin kıdemli araştırmacısı

### ÖZET

1990-1992'den itibaren küreselleşme terimini sıklıkla duyduk ve gün geçtikçe bu kavramın bilimsel eserlerde ve süreli yayınlarda nasıl güncelliğini koruduğuna tanık olduk. Küreselleşme özünde toplumun tarihsel gelişiminin yeni bir ifadesi, gelişim süreci ve yeni bir adı olsa da geçmiş yıllarda bu sürecin farklı kavramlarla var olduğu bilinmektedir. Bu kavram zamanla özellikle sanayi ve teknoloji alanında kendini göstermiştir. Dünyada yaşanan süreçleri dikkate aldığımızda küreselleşmenin 21. yüzyılda insanlığın gelişimi ve gelecekteki kalkınmasının kriterini oluşturacağını söyleyebiliriz. Çünkü tarihte yaşanan pek çok olayın cevabının, zaman geçtikçe yeni bir özde, yeni bir anlamla yankılandığını görüyoruz.

İnsanlık tarih boyunca her zaman bütünleşme, tek bir siyasi, ekonomik veya sosyo-kültürel alanın parçası olma çabası içinde olmuştur. Bu nedenle küreselleşme süreci yeni bir olgu olarak değerlendirilmemektedir. Tarih, bu tür örnekleri yaratarak şu veya bu imparatorluğa askeri-siyasi ve ekonomik nüfuz alanını iki, bazen de üç kıtaya genişletme fırsatını vermiştir. Üç dünya dininin ortaya çıkışı, dünya alanının küresel entegrasyonunun yeni bir örneğini yarattı. Yahudilik, Hıristiyanlık ve ardından İslam, sosyokültürel, politik ve ekonomik gerçeklik algısı üzerindeki etkilerinin sınırlarını genişletti ve esas olarak şu veya bu dinin temsilcilerinin yaşadığı yerler yarattı.

Hoşgörü ortamının oluşmasını ve gelişmesini engellemek için hain güçler ilk önce tarihte yaşanan savaşları ve malum 11 Eylül olayını tarih dışı tutmayı başardılar. İşte bu nedendir ki, medeniyetler çatışması teorisi ve bunun İslam dünyasının Batı ile ilişkilerine etkisi sonucunda diyalog ve hoşgörü, karmaşık ve hassas konular haline gelmiştir. Özellikle kültürlerin çatışmasına siyasi bir elbise giydirilmesi ve bilinen kavramın uluslararası politikada önemli bir unsur haline getirilmesi zemininde bu durum daha da belirginleşti.

Bu makalede, küreselleşme çağında medeniyetler arası ilişkilerde hoşgörü ortamının oluşması ve gelişmesinin yönleri hakkında bilgi verilmekte, uluslararası varlığın ve karşılıklı anlayışın ana yönlerine dikkat çekilmektedir. Dünyamızın huzurlu ve barış dolu olmasını istiyorsak en azından hoşgörülü olmalı ve bu ortamı yaratmak için herkes adım atabilmelidir.

**Anahtar kelimeler:** Küreselleşme, hoşgörü, küresel entegrasyon, İslam, Doğu-Batı.



## ABSTRACT

We have often heard the term globalization since 1990-1992 and today As time goes by, we see how this concept remains current in scientific works and periodicals.

We witnessed his protection. Globalization is essentially a new development of the historical development of society. Although it has a development process and a new name, this process has been described differently in the past years. It is known that it exists with concepts. This concept has been used over time, especially in industry and

has proven itself in the field of technology. When we take into account the processes taking place in the world We can say that globalization will constitute the criterion for the development and future development of humanity in the 21st century. Because we see that the answers to many events in history resonate with a new essence and a new meaning as time passes.

Throughout history, humanity has always been integrated, integrated into a single political, economic or has made an effort to become a part of the socio-cultural field. Therefore globalization The process is not considered a new phenomenon. By creating such examples, history giving this or that empire two, and sometimes three, spheres of military-political and economic influence. It gave the continent the opportunity to expand. The emergence of the three world religions It created a new example of global integration. Judaism, Christianity and then The effects of Islam on the perception of sociocultural, political and economic reality expanded its borders and places where mainly representatives of one or another religion live created.

In order to prevent the formation and development of an environment of tolerance, treacherous forces were the first to First, they managed to keep the wars in history and the known September 11 incident out of history. This is why the theory of the clash of civilizations and its relationship between the Islamic world and the West.

As a result of its impact on relations, dialogue and tolerance have become complex and sensitive issues. has arrived. In particular, the clash of cultures is dressed in a political dress and the known On the basis of making the concept an important element in international politics, this The situation became even more obvious.

In this article, tolerance in relations between civilizations in the age of globalization information is given about the formation and development of the international Attention is drawn to the main aspects of existence and mutual understanding. Our world is peaceful And if we want it to be peaceful, we must at least be tolerant and create this environment. Everyone should be able to take steps.

**Key words:** Globalization, tolerance, global integration, Islam, East-West.



## **LEARNING TO LISTEN: SOME LISTENING COMPREHENSION STRATEGIES**

**Assoc. Prof. Dr. Romanova ANASTASIA**

ORCID ID 0000-0003-2683-9827

The Academy of Economic Studies of Moldova

### **ABSTRACT**

The article presents arguments for an emphasis on listening comprehension in foreign language learning/teaching. An emphasis on listening comprehension, as well as the application of listening strategies, will help students to capitalize on the language input they receive, and to achieve greater success in language learning.

The article provides an overview of listening comprehension process because understanding how foreign language listening comprehension works can have a serious influence on choosing teaching strategies and techniques. Learning strategies are useful tools for students because they open up more reliable and less frustrating routes to language learning success. Our teaching practice allows us to see prospects for further research in the development of the described problem and overcoming the existing gap that between the scientific and theoretical knowledge and experience of English (or another second language) teachers.

The major part of the article presents and discusses pedagogical recommendations. It has also provided some concrete activities for developing listening strategies.

The materials of this article may be of use to those who are interested in problems of speech perception and improving the existing listening comprehension teaching techniques.

**Key words:** listening comprehension, teaching techniques.



## A MATHEMATICAL MODEL FOR OPTIMISING PASSIVE INDOOR THERMAL AND VISUAL COMFORT IN SINGLE BANKED OFFICE BUILDINGS IN TEMPERATE DRY CLIMATE OF NIGERIA

**Dr. Muhammad Aminu MUSA**

Department of Architecture, Faculty of Environmental Design, Ahmadu Bello University, Zaria,  
ORCID number: 0000-0003-4516-1281

### ABSTRACT

Many researchers have differed on the optimum values of Passive Indoor Thermal and Visual Comfort (PITVC) determinants in tropical climates. The study is aimed at developing a model for enhancing PITVC in singled-banked midrise office buildings, during the activity period (8 am to 5 pm), in the temperate dry climate of Nigeria. It was achieved by evaluating the effects WWR, R-values and shading device on PITVC. A quantitative research design using an explorative design approach was employed in the study as well as an experimental research strategy through simulation method to enhanced PITVC. The study used iterative prototype of which the Federal Secretariat was used as single-banked office building. The Google Sketch-Up 2017 and OpenStudio simulation tool were used to evaluate the prototype building from January to December 2018. The data generated was analysed using relevant statistical tools (MANOVA, ANOVA, t-test, bar charts, column charts, graphs, and Tables). The findings revealed that, the best WWR for visual and thermal comfort are 20% and 15% respectively while the compromise value was 20%. It was also noted that, R-value of external wall insulation material does not affect the visual comfort of an office building but affect operative temperature as well as relative humidity as the optimum value was found to be 3.26 m<sup>2</sup>·K/W. The mathematical model was developed as:  $A = 224.58 - 1254.84WWR + 102.87PF - 4.11R \dots \dots 1$  Where A is orientation, WWR window to wall ratio, PF projection factor and R is the R-value of the external wall materials.

**Keywords:** Daylight autonomy, Operative temperature, Single-banked officebuilding, Thermal comfort, Visual comfort.



**ANALYZING MAGNETO HYDRODYNAMIC BLOOD FLOW CONVINCED  
PERISTALTICALLY: A STUDY OF NON-LINEAR MODELS IN AN ASYMMETRIC  
CHANNEL**

**Assist. Prof. Dr. Bilal AHMED**

University of Science and Technology of Fujairah (UAE)

**ABSTRACT**

Numerically investigated analysis occupying considerations free from long wavelength and creeping flow regime has been addressed in this paper for non-Newtonian Casson fluid induced by peristaltic activity. Rheological measurements have been exposed by fluid progression in the asymmetric conduit influenced by a normally settled magnetic field. The analysis is made without implementation of the lubrication theory which allows the role of inertial forces in the flow model not addresses before. Galerkin formulated finite element method is practiced by simplifying full Navier-Stokes equations to assure the appearance of non-trivial Reynolds number and wave independence in an ongoing study. The solution hinged based on code formulated in MATLAB for velocity distribution, pressure profiles, vorticity lines, and stream function is graphically plotted. It has been deduced that inflating the Casson fluid parameter ( $0.1 \leq \beta \leq 0.5$ ) drives an inappreciable reduction in velocity close to the central region and vorticity lines to remain unaffected. An appreciable increase in bolus formation is inspected by rising time mean flow ( $1.1 \leq Q \leq 1.6$ ) with the diffusion of streamlines in the provision of a progressive phase in waves.

**Keywords:** Peristaltic flow, Inertial forces, Blood Flow Model, Casson fluid, Asymmtric Channel, Finite element technique.



**THE PROBLEM OF STYLISTIC DEVICES AND EXPRESSIVE MEANS IN  
TRANSLATION BASED ON THE BOOK “THE IMAGE OF AZERBAIJAN IN THE  
ENGLISH LANGUAGE PRESS DURING THE PERIOD OF INDEPENDENCE”**

**Eleonora Lutvig gizi Babayeva**

Azerbaijan University of Languages

<https://orcid.org/0000-0001-7818-9526>

**ABSTRACT**

Translation is closely connected with stylistics because stylistics aims to explain what a text means rather than just what it means, and knowing what texts mean is essential for translation. Stylistics explains the fine detail of a text such as why certain structures are ambiguous or how a metaphor works, and is used to describe both literary and non-literary texts.

In its etymological sense expressiveness may be understood as “a kind of intensification of an utterance or a part of it depending on the position in the utterance of the means that manifest this category and what these means do.” A stylistic device is a conscious and intentional intensification of some typical structure. A stylistic device is a conscious and intentional intensification of some typical structure and/or semantic property of a language unit (neutral or expressive) promoted to a generalized status and thus becoming a generative model. The difference between expressive means and stylistic devices is that expressive means are more predictable than stylistic devices. Stylistic devices clarify a larger amount of information and demand some effort to interpret their meaning.

The colorful quality of speech is also of great importance. The emergence of this quality is primarily closely connected to the richness of the word stock of the languages and its semantics. The main aspect that distinguishes the speech of a newspaper from the speech of a famous writer is the richness of linguistic units in fiction. Undoubtedly, the leading role comes from polysemy, expressive means i.e. metaphors. The trope (figurative expression) is one of the categories of language. Human thinking is constantly excited, a metaphor arises because it tends to aesthetics and figurativeness. Hence the trope is closely related to human psychology. The metaphors that exist in the language of each nation are related to geographical location, nature, climate, environment, economic activity, and other such conditions where that nation lives. In our national literature, sycamore, cypress, pine, the names of trees such as lilac and oak are used in expressive meanings. Beautiful women and their features are usually compared to a rose. But in Indian poetry, the same comparison is depicted with a lotus flower.

On the other hand, any object or event does not evoke the same feeling in every nation. I mean, in the mentality and language of a people, this or that object renders a positive poetic image, while, in the way of thinking of another nation, the same object evokes a negative expression.

**Keywords:** trope, figurative expression, categories of language, metaphor, stylistic devices



**SYNTHESIS AND ANTIMICROBIAL ACTIVITY OF 2-METHOXY-4-[(2-PHENYLHYDRAZONO) METHYL] PHENOL**

**Isma'il IBRAHIM**

Department of Pure and Industrial Chemistry, Umaru Musa Yar'adua University, P. M. B 2218,  
Katsina, Nigeria

**Yusuf HASSAN**

Department of Pure and Industrial Chemistry, Umaru Musa Yar'adua University, P. M. B 2218,  
Katsina, Nigeria.

**ABSTRACT**

In this work, a known hydrazone prepared by reacting 4-hydroxy-3-methoxy benzaldehyde with phenyl hydrazine at reflux temperature has been reported. The synthesised compound was confirmed from the FT-IR spectra where the carbonyl band ( $1700\text{cm}^{-1}$ ) in the starting benzaldehyde was found to shift to the relevant imine band ( $1602\text{cm}^{-1}$ ). Screening of the compound for antimicrobial activity against two bacterial and fungal species showed that the compound was reasonably active with MIC values of  $10\ \mu\text{g/mL}$ ,  $5\ \mu\text{g/mL}$ ,  $2.5\ \mu\text{g/mL}$ , and  $1.25\ \mu\text{g/mL}$  against *Salmonella*, *S. aureus*, *A. niger* and *T. subsane*. While the MBC values were found to be  $10\ \mu\text{g/mL}$ ,  $5\ \mu\text{g/mL}$ ,  $2.5\ \mu\text{g/mL}$ , and  $1.25\ \mu\text{g/mL}$ , and the MFC values were found to be  $10\ \mu\text{g/mL}$ ,  $5\ \mu\text{g/mL}$ ,  $2.5\ \mu\text{g/mL}$ , and  $1.25\ \mu\text{g/mL}$ .

**Keywords:** Hydrazone, Phenylhydrazine, imine, Carbonyl band.





## NAVIGATING THE INTERSECTION: ISLAM AND SECULARISM IN CONTEMPORARY SOCIETIES

**Mohd SUALH**

Aligarh Muslim University (INDIA)  
<https://orcid.org/0009-0004-7016-8535>

**Saifullah REHMANI**

Aligarh Muslim University (INDIA)  
<https://orcid.org/0009-0008-3014-4087>

### ABSTRACT

This study explores the changing dynamics in modern Muslim-majority cultures by examining the complex tapestry created by the historical interactions between Islam and secularism. By analyzing the political and social facets of this intricate relationship, the research seeks to clarify its complicated interdependence.

After providing a brief historical summary, the study outlines the complex evolution of secular thinking in Islamic civilizations from the time of the early caliphates to the present. The goal of the research is to uncover the layers that have molded the coexistence—or occasionally conflict—between Islamic ideals and secular administration via a detailed investigation of significant historical events and intellectual foundations.

In addition, the study examines the current situation, closely examining how various countries with a majority of Muslims manage to strike a balance between their Islamic customs and the requirements of a secular political system. This entails analyzing the difficulties encountered and chances created by this cohabitation while taking individual liberties, societal cohesiveness, and political stability into account.

This study attempts to add to a comprehensive understanding of the complex connection between Islam and secularism by combining historical viewpoints with modern reality.

**Keywords:** Islam, Secularism, Intersection, Muslim, Political



## NUMERICAL STUDY OF PHYSIOLOGICAL BLOOD FLOW WITH STRETCHING CAPILLARY ON MHD MICROPOLAR FLUID

**Dr. Binyam ZIGTA**

Wachemo University, College of Natural and Computational Science,  
Department of Mathematics  
P. O. Box 138, ETHIOPIA

### ABSTRACT

Numerical analysis of mixed convection flow of MHD micropolar fluid with stretching capillary in the presence of thermal radiation, chemical reaction and viscous dissipation has been studied. The governing non linear partial differential equations of momentum, angular velocity, energy and concentration are converted into ordinary differential equations using similarity transformations which can be solved numerically. The dimensionless governing equations are solved using ode45. The effect of physical parameters such as micropolar parameter, Hartmann number, microinertial density parameter, thermal radiation parameter, Eckert number, Schmidt number and chemical reaction parameter on flow variables i.e., velocity of micropolar fluid, microrotation, temperature and concentration has been discussed graphically. MATLAB code is used to analyze numerical facts. Furthermore, computational values of local skin friction coefficient, local wall coupled coefficient, local Nusselt number and local Sherwood number for different values of parameters have been investigated.

**Keywords:** thermal radiation, chemical reaction, viscous dissipation, micropolar fluid, similarity transformation.



## HEAVY METAL CONTENT OF THE LINDEN PLANT GROWED IN VAN/TURKEY PROVINCE

VAN/TÜRKİYE LOKASYONUNDA YETİŞTİRİLMİŞ OLAN IHLAMUR BİTKİSİNİN  
AĞIR METAL İÇERİĞİ

**Assist. Prof. Dr. Tülay GÜRSOY**

Faculty of Science, Department of Chemistry, Yüzüncü Yıl University, Van, Turkey,

Orcid No: 0000-0001-6166-6875

**Assoc. Prof. Dr. Nurhayat ATASOY**

Faculty of Science, Department of Chemistry, Yüzüncü Yıl University, Van, Turkey,

Orcid No: 0000-0002-2171-3996

### ABSTRACT

Heavy metal pollution is one of the important environmental hazards that negatively affects living health and causes losses in agricultural productivity. Heavy metals have spread into the atmosphere, water and soil since ancient times as a result of human activities, unlike natural means. In this research study, the linden plant (*Tilia Cordata*) used for beverage and treatment purposes was taken from two different locations, its species and taxa were determined, and some heavy metal amounts (As, Cd, Co, Cr, Cu, P, Pb, S, Zn) found in the dried flower part were examined. The samples were fragmented (burned) by the microwave method and measurements were determined with the ICP-OES (Inductively Coupled Plasma Optical Emission Spectrometry) spectrometer. The analysis results were compared among themselves and with the standards set by the World Health Organization and determinations were made. Heavy metal contents of plant samples include; differences have been detected due to growing in different soil conditions and the variability of microelement levels in the soil.

**Key Words:** linden, location, heavy metal



## ÖZET

Ağır metal kirliliği, canlı sağlığını olumsuz etkileyen ve tarımsal verimde kayıplara neden olan önemli çevresel tehlikelerden biridir. Ağır metaller eski çağlardan beri insan faaliyetleri sonucu olarak doğal yollardan farklı olarak atmosfer, su ve toprağa yayılmışlardır. Bu araştırma çalışmasında, içecek ve tedavi amacıyla kullanılan ıhlamur bitkisinin (*Tilia Cordata*) iki ayrı lokasyondan alınmış, tür ve taksonları belirlenmiş, kurutulmuş halde çiçek kısmında bulunan bazı ağır metal miktarları (As, Cd, Co, Cr, Cu, P, Pb, S, Zn) ölçülmüştür. Örnekler mikrodalga yöntemi ile parçalanmış (yakılmış) ve ICP-OES (Inductively Coupled Plasma Optical Emission Spectrometry) spektrometre ile ölçümler belirlenmiştir. Analiz sonuçları kendi aralarında ve Dünya Sağlık Örgütü'nün belirlediği standartlar ile kıyaslanmış ve tespitlerde bulunulmuştur. Bitki numunelerinin ağır metal içerikleri arasında; farklı toprak koşullarında yetişmesi ve toprakların mikroelement seviyelerinin değişkenliğinden kaynaklanan farklılıklar tespit edilmiştir.

**Anahtar Kelimeler:** ıhlamur, lokasyon, ağır metal



**HEAVY METAL CONTENT OF THE WATERCANE PLANT GROWED IN  
VAN/TURKEY PROVINCE**

VAN/TÜRKİYE LOKASYONUNDA YETİŞTİRİLMİŞ OLAN IHLAMUR BİTKİSİNİN  
AĞIR METAL İÇERİĞİ

**Assist. Prof. Dr. Tülay GÜRSOY**

Faculty of Science, Department of Chemistry, Yüzüncü Yıl University, Van, Turkey,

Orcid No: 0000-0001-6166-6875

**Assoc. Prof. Dr. Nurhayat ATASOY**

Faculty of Science, Department of Chemistry, Yüzüncü Yıl University, Van, Turkey,

Orcid No: 0000-0002-2171-3996

**ABSTRACT**

Heavy metals; they are elements that have metallic properties, have a relatively high density, and can have toxic effects even at low concentrations. Heavy metals can accumulate in and around concentrated heavy metal sources, in the air, in the soil and in drinking or underground water sources, originating from the place and products of industrial production or from the activities carried out and existing and prepared materials in the industrial area. In this research study, watercane plant (*Phragmites australis L.*) grown in three different locations was taken, its species and taxa were determined, and the amounts of some heavy metal amounts (As, Cd, Co, Cr, Cu, P, Pb, S, Zn) in the dried flower part were examined. The samples were fragmented (burned) by the microwave method and measurements were determined with the ICP-OES (Inductively Coupled Plasma Optical Emission Spectrometry) spectrometer. The analysis results were compared among themselves and with the standards set by the World Health Organization and determinations were made. Results have been obtained regarding environmental pollution depending on their locations and the industrial, transportation and humanitarian activities carried out in their locations.

**Key Words:** watercane, location, heavy metal



## ÖZET

Ağır metaller; metalik özellik gösteren, göreceli olarak yüksek yoğunluğa sahip, düşük derişimlerde bile toksik etki gösterebilen elementlerdir. Ağır metaller, endüstriyel üretimin yapıldığı yer ve ürünlerden veya sanayi bölgesinde gerçekleştirilen faaliyet ve mevcut ve hazırlanan malzemelerden kaynaklanan, yoğunlaştırılmış ağır metal kaynaklarının içinde ve çevresinde, havada, toprakta ve içme veya yer altı su kaynaklarında birikebilmektedir. Bu araştırma çalışmasında, üç ayrı lokasyonda yetişmiş su kamışı bitkisi (*Phragmites australis L.*) alınmış, tür ve taksonu belirlenmiş, kuru çiçek kısmında bulunan bazı ağır metal miktarları (As, Cd, Co, Cr, Cu, P, Pb, S, Zn) ölçülmüştür. Örnekler mikrodalga yöntemi ile parçalanmış (yakılmış) ve ICP-OES (Inductively Coupled Plasma Optical Emission Spectrometry) spektrometre ile ölçümler belirlenmiştir. Analiz sonuçları kendi aralarında ve Dünya Sağlık Örgütü'nün belirlediği standartlar ile kıyaslanmış ve tespitlerde bulunulmuştur. Lokasyonlarına, lokasyonlarında gerçekleştirilen endüstriyel, ulaşım ve insani faaliyetlere bağlı olarak çevresel kirlilik ile ilgili olarak sonuçlar elde edilmiştir.

**Anahtar Kelimeler:** Su kamışı, lokasyon, ağır metal



## **A REVIEW: CHOLESTEROL AND ITS MANAGEMENT**

**Neha SINGH**

Mangalayatan University (India), Aligarh

**Suneel KUMAR**

Mangalayatan University (India), Aligarh

### **ABSTRACT**

The majority of human cells synthesize cholesterol, primarily in the liver, making it the most significant sterol. It serves as a precursor for the production of bile acids, vitamin D, and steroid hormones and is an essential part of cell membrane. The body basically regulates cholesterol homeostasis too much. This review focuses on the following: the origin of cholesterol, the biological functions of cholesterol, its structural description, its biosynthesis, cholesterol and its derivatives, such as bile acids, bile salts, and steroid hormone, as well as the current developments in cholesterol management against risk factors of cardiovascular diseases, such as coronary heart disease, stroke, and atherosclerosis. Pharmaceutical and non-pharmaceutical medications, herbs, dietary changes, and exercise are all currently recommended interventions for the management and prevention of cardiovascular disease.

**Keywords:** Cardiovascular disease, LDL, HDL, ASCVD, NADPH, ATP



**THE ROLE OF TRAINING PROGRAMS IN INCREASING THE LEVEL  
OF FAMILIARITY OF JOB PERFORMANCE  
APPLIED STUDY ON BAB ALBAHAR HOTEL IN TRIPOLI – LIBYA**

**Mr. Salem Mansour Gwirb**

Faculty of Tourism & Hospitality Musrata-Libya

**Mr. Ebrahim Mohamed Alawj**

Faculty of Tourism & Hospitality Musrata-Libya

**ABSTRACT**

The study objective is to identify the role of training programs in increasing the level of familiarity of job performance for employees in Bab Albahar hotel in Tripoli – Libya. In this study the descriptive analytical research method adopted and questionnaires were employed to collect data and information. Random sample were targeted (77) employees from the hotel, which represent (15%) of the study society who were (522) employees. Total of (72) questionnaires were analyzed and entered the study, which represent (94%) of the distributed questionnaires. The statistical package for social sciences (SPSS) was used to analyze the data and information of the study and test out its hypothesis. The study reached a number of results

**Keywords:** Bab Albahar Hotel, Training programmers, Job performance, Level of familiarity.





## دور البرامج التدريبية في الرفع من مستوى الإمام بالأداء الوظيفي

دراسة ميدانية على فندق باب البحر - طرابلس

أسالم علي قويرب

كلية السياحة والخدمات الفندقية - مصراته

أ. ابراهيم محمد الاعوج

كلية السياحة والخدمات الفندقية - مصراته

### المستخلص

هدفت الدراسة إلى التعرف على دور البرامج التدريبية في الرفع من مستوى الإمام بالأداء الوظيفي للموظفين بفندق باب البحر في مدينة طرابلس. وتم القيام بمجموعة من الخطوات والإجراءات المنهجية، حيث اعتمدت الدراسة على المنهج الوصفي التحليلي، واستخدم الباحث الاستبانة، لجمع بيانات الدراسة. استهدفت الدراسة عينة عشوائية من العاملين بالفندق قيد الدراسة حجمها (77) مفردة، اختيرت بطريقة العينة العشوائية البسيطة، وهي تمثل ما نسبته (15%) من حجم المجتمع الأصلي البالغ عددهم (522) موظفاً. وقد بلغ عدد الاستمارات الخاضعة للتحليل (72) استمارة، شكلت ما نسبته (94%) من عدد الاستمارات الموزعة، وتم تحليل البيانات والمعلومات التي تم جمعها خلال فترة الدراسة وتحليلها واختبار فرضيتها من خلال استخدام الحزمة الإحصائية للبحوث الاجتماعية (SPSS). وتوصلت الدراسة إلى عدد من النتائج أهمها: أن المتوسط الحسابي للفقرة التي تنص على يتوافق محتوى البرامج التدريبية مع متطلبات الوظيفة التي تعمل بها منخفض. وبالاعتماد على النتائج تم التوصل إلى عدد من التوصيات أهمها: ضرورة تناسب البرامج التدريبية التي يحصل عليها العاملين مع طبيعة أعمالهم، وذلك للرفع من كفاءة العاملين مما يساهم في تحسين أدائهم.

الكلمات المفتاحية: فندق باب البحر، البرامج التدريبية، الإمام، الاداء الوظيفي.

### 1.1 مقدمة

تسعى المنظمات الخدمية في جميع أنحاء العالم إلى تحقيق أهداف يتم من ورائها الحصول على الجودة والتميز. وبظهور حركة الإدارة العلمية بدء رسم مكان واضح لهذا العنصر، حيث أصبح العنصر البشري أهم مورد من الموارد المطلوبة بالمنظمة حتى تضمن نجاحها واستمرارها. وتدريب العنصر البشري له دور هام في تغيير الممارسات المرتبطة بوظائف إدارة الموارد البشرية وبالتالي فإن الاعتماد على العناصر البشرية المدربة، والاهتمام والعناية بها من خلال العمل على زيادة معارفها وتنمية مهاراتها وتصحيح سلوكها واتجاهاتها في مجال عملها لمواكبة الحاضر ومواجهة المستقبل بكل ثقة في النفس وكفاءة وفاعلية في الأداء، حيث أن ذلك يتوقف على مجموعة كبيرة من العوامل أهمها دور البرامج التدريبية.



يُعد التدريب في وقتنا الحاضر استثماراً رئيسياً في رأس المال البشري، ولذلك يعتبر من أهم الطرق الهادفة إلى توفير عناصر بشرية ذات أداء عالي من حيث الكم والنوع باعتبار أن التدريب يهدف إلى تزويد العاملين في كافة المنظمات بالسلوكيات والمعلومات والمهارات الإدارية والفنية اللازمة لأداء أعمالهم بأفضل الطرق، وبالتالي تتحقق الكفاءة والفاعلية في الاعمال المكلف بها العاملين بالفندق قيد الدراسة. وفي هذه الورقة تم التطرق الى عدد من المعلومات المتعلقة بتعريفات التدريب، ومفهومه للمنظمة والعاملين بها.

## 2.1 مفهوم التدريب

هناك تعريفات عديدة لتدريب نذكر منها:-

يعرف التدريب بأنه:- عملية صقل وتنمية للمهارات في سياق معرفي ومنهجي، و "عملي"(العساف، 2008). ويعرف التدريب أيضا بأنه نشاط هام ورئيسي من أنشطة الموارد البشرية في المؤسسات التي تهتم بالخدمات الحيوية كما إن يعمل على تزويد معدلات أدائهم (بلوط، 2002).

والتدريب كما عرفه أبو النصر هو عبارة عن: عملية إعداد الفرد للعمل المستمر والاحتفاظ به على مستوى الخدمة المطلوبة، فهو نوع من التوجيه صادر من انسان موجه إلى انسان آخر (أبو النصر، 2008).  
التدريب عرف كذلك بأنه تلك الجهود الهادفة إلى تزويد العامل بالمعلومات والمعارف التي تكتسبها مهارة في أداء العمل وتنمية مهارات ومعارف وخبرات باتجاه زيادة كفاءة الفرد العالية و المستقبلية (عبد الباقي ، 2000)  
يعرف الطعاني التدريب بأنه عملية تهدف إلى معاون الافراد على تحسين وتطوير وتنمية خبراتهم ومهاراتهم وزيادة معلوماتهم بهدف تغيير أو تعديل لسلوكهم واتجاهاتهم للتأكيد على النواحي الايجابية في العمل (الطعاني، 2013).  
التدريب هو وسيلة حديثة وفعالة لتحسين وتطوير أي مجال من المجالات الحياتية المختلفة، أكان ذلك في المجال الشخصي، الدراسي، المالي، العملي، العائلي، الصحي أو أي مجال آخر، والتدريب اليوم يحتل مكانة مركزية بالعالم كوسيلة هامة وفعالة لتحقيق الأهداف عن طريق تقسيمها لمهام صغيرة. لقد أصبحت صناعة التدريب من الصناعات الثقيلة التي تحتاج الي مدخلات محددة، ويجب أن تتوافر لهذه المدخلات معايير محددة ايضاً من الجودة حتي نستطيع أن نحقق المفهوم الصحيح للتدريب، ونعدل المفاهيم القديمة، وهو أن التدريب ليس مجرد صرف ولكنه استثمار عالي القيمة. (<https://ar.wikipedia.org>)

وأشار عباس إلى أن التدريب هو : نشاط تعليمي معتمد تمارسه المنظمة بهدف تحسين أداء الفرد في الوظيفة والتي يمثلها(عباس، 2003)

يعرف التدريب بأنه جهد نظامي متكامل مستمر يهدف إلى إثراء أو تنمية معرفة الفرد ومهاراته وسلوكه لأداء عمله بدرجة عالية من الكفاءة والفاعلية. (<https://www.annajah.net>)

يعرف التدريب بكونه جزء لا يتجزأ من العمليات العلمية الهادفة والمخصّصة والموجهة والتي يخضع لها المتدرب من أجل الحصول على خبرة في مجال معين، وذلك بهدف رفع كفاءته في هذا المجال إلى أقصى حدّ ممكن، مما يجعله قادراً على خوض هذا المجال ومناقسة المتخصّصين فيه والتميز بينهم. (<https://mawdoo3.com>)

## 3.1 أهمية التدريب



يمكن القول إن التدريب في الأونة الأخيرة تزايد الاهتمام به نظراً لأهميته الكبيرة في تحقيق التنمية البشرية، حيث أصبح الاهتمام بالتدريب ضرورياً نتيجة التطور التكنولوجي الهائل ومرافقته من ابتكار الطرق الجديدة في أداء الأعمال مما يوفر الوقت والجهد فالعولمة وما رافقها من انفتاح الدول على بعضها عمل على إدراك المنظمات لأهمية التدريب وتطبيق مبادئ الجودة الشاملة والتحسين المستمر لكافة الموارد البشرية للمنظمة لمواجهة المتغيرات نتيجة التطور التكنولوجي سواء كان داخلي أو خارجي وإدراك المنظمات في الوقت الحالي لأهمية التدريب في تحقيق الأهداف التنظيمية المطلوبة ودورة الكبير في رفع أداء الخدمة لموظفي المنظمة وتيسير طرق انسيابية العمل وتطوير مهارات العاملين وتعريفهم بما هو مطلوب منهم وكيفية التعامل مع الآخرين وإدراك المنظمة لدورات التدريب في فهم السياسات العامة وتطور اساليب موظفيها وبناء قاعدة فعالة للاتصالات الداخلية وذلك بهدف تطوير برامجها وإمكانياتها وتحديد المعلومات التي تحتاجها لصياغة أهدافها وتنفيذ سياساتها للرفع من أداء الخدمة لموظفيها. ( إبراهيم، 2002).

### 1.3.1 أهمية التدريب للمنظمة

تتمثل أهمية التدريب للمنظمة في رفع مستوى الأداء التنظيمي وذلك من خلال الدور الذي يلعبه في تزويد الأفراد العاملين بالمهارات والسلوكيات والمعارف اللازمة لأداء وظائفهم وتعريفهم بما هو مطلوب منهم وبالصورة التي تمكنهم من تنفيذ المهام الموكلة إليهم بكفاءة وفاعلية، وهو الأمر الذي يؤدي بدوره إلى معالجة المشاكل والقصور في الأداء الكلي من تخفيض في التكاليف وتقليص النفقات الناجمة عن الحوادث وعدم الكفاءة وتوفير كادر من القادة المؤهلين وتقليل معدلات دوران العمل بسبب عدم تكييف العاملين مع الوظائف التي يشغلونها أو بسبب عدم التوافق بين متطلبات هذه الوظائف والقدرات والمهارات التي يتمتع بها هؤلاء العاملين (سهيلة عباس ، 2003).

### 2.3.1 أهمية التدريب بالنسبة للعاملين

يحقق التدريب فوائد أخرى بالنسبة للعاملين من أهمها:-

- 1- المساعدة على تحسين فهمهم للمنظمة وتوضيح أدوارهم فيها.
- 2- مساعدتهم في حل مشاكلهم العمل.
- 3- يطور وينمي الدافعية نحو الأداء ويخلق فرصاً للنمو والتطور لدى العاملين.
- 4- مساعدتهم في التقليل من التوتر الناتج عن النقص في الإلمام أو المهارة أو كليهما.
- 5- يساهم في تنمية القدرات الذاتية للإدارة والرفاهية لدى العاملين.

### 4.1 منهجية الدراسة

1. منهج الدراسة: تم استخدام المنهج الوصفي التحليلي، لجمع بيانات الدراسة وتبويبها وعرضها وتحليلها.
2. مجتمع وعينة الدراسة: تكون مجتمع الدراسة من الموظفين بفندق باب البحر في مدينة طرابلس والبالغ عددهم (522) موظفاً. وتم استهداف عينة عشوائية قوامها (77) مفردة، خضع منها للتحليل (72) مفردة.
3. ادوات جمع البيانات: اعتمد الباحث على الاستبانة كأداة رئيسية في جمع البيانات المتعلقة بالدراسة.



4. الأساليب الإحصائية المستخدمة: تم الاعتماد على برنامج الحزمة الإحصائية للعلوم الاجتماعية (SPSS).

### 5.1 التحليل الاحصائي

#### الجدول (1) المتوسط الحسابي والانحراف المعياري لفقرات متغير برامج التدريب

مستوى الموافقة	الانحراف المعياري	المتوسط الحسابي	العبارة
منخفض	1.160	2.32	1 تضع الشركة برامج تدريبية بصفة دورية ومستمرة.
منخفض	1.160	2.34	2 تحقق البرامج التدريبية الأهداف الموضوعية لأجلها.
منخفض	1.160	2.40	3 يتوافق محتوى البرامج التدريبية مع متطلبات الوظيفة التي تعمل بها.
متوسط	1.457	3.14	4 تساعد البرامج التدريبية في تحسين مهارات ومعارف الموظفين.
متوسط	1.328	2.79	5 تساهم برامج التدريب في تغطية جوانب العجز في الأداء
منخفض	1.160	2.42	6 تزيد البرامج التدريبية المستخدمة من مستوى كفاءة أداء الموظفين بشكل ملحوظ.
منخفض	1.023	2.57	المتوسط الحسابي العام لبرامج التدريب

المصدر: الدراسة الميدانية

يتضح من الجدول السابق أن الفقرة التي تنص على أنه (تساعد البرامج التدريبية في تحسين مهارات ومعارف الموظفين) جاءت في المرتبة الأولى بمتوسط حسابي (3.14)، وانحراف معياري (1.457)، بمستوى موافقة متوسط، في حين جاءت الفقرة التي تنص على: (تضع الشركة برامج تدريبية بصفة دورية ومستمرة)، في المرتبة الأخيرة، بمتوسط حسابي (2.32) وانحراف معياري (1.160)، بمستوى موافقة منخفض، ونلاحظ أن اتجاهات أفراد عينة الدراسة حول هذا البُعد جاءت بدرجة موافقة منخفضة لأغلب الفقرات وبانحرافات صغيرة، مما يشير إلى عدم تشتت اتجاهات العينة، وأخيراً بلغ المتوسط الحسابي العام لمتغير برامج التدريب (2.57)، وبانحراف معياري (1.023)، مما يؤكد أن اتجاهات أفراد العينة جاءت بدرجة موافقة منخفضة، ويدل على أن مستوى توفر برامج التدريب كُبعد من أبعاد التدريب كان منخفضاً من وجهة نظر العينة المستهدفة.

ولمعرفة ما إذا كان هناك أثر ذو دلالة إحصائية لبرامج التدريب كمتغير مستقل، والالمام بالأداء الوظيفي كمتغير

تابع، تم استخدام تحليل الانحدار الخطي البسيط، والجدول الآتي يبين ذلك:-

#### الجدول (2) المتوسط الحسابي والانحراف المعياري لفقرة الالمام بالأداء الوظيفي



**ATLAS 11. INTERNATIONAL  
CONGRESS ON ADVANCED SCIENTIFIC STUDIES AND INTERDISCIPLINARY RESEARCH**

مستوى الموافقة	الانحراف المعياري	المتوسط الحسابي	العبارة	
منخفض	0.952	2.30	أعتمد على أنفسي في إنجاز العمل.	1
متوسط	1.292	2.78	افهم مشاكل عملي وأعمل على حلها.	2
منخفض	1.009	2.25	لا يوجد شكاوى عن أداء عملي.	3
منخفض	0.952	2.34	أمتاز بسرعة الملاحظة والفهم.	4
متوسط	1.274	2.70	لدي اليقظة والتركيز التامين أثناء العمل.	5
منخفض	0.964	2.35	لدى القدرة على تصحيح الأخطاء الناتجة أثناء العمل.	6
منخفض	1.014	2.23	لا أرتكب أخطاء كثيرة عند إنجاز عملي.	7
منخفض	0.964	2.45	لدي القدرة على حل مشاكل العمل.	8
منخفض	0.934	2.42	المتوسط الحسابي العام للإمام بالأداء الوظيفي	

المصدر: الدراسة الميدانية

يتضح من الجدول السابق بالنسبة لعنصر الإمام بالأداء الوظيفي أن الفقرة التي تنص على أن: (أفهم مشاكل عملي وأعمل على حلها) جاءت في المرتبة الأولى بمتوسط حسابي (2.78) وانحراف معياري (1.292)، بمستوى موافقة متوسط، في حين جاءت الفقرة التي تنص على أنه: (لا ارتكب أخطاء كثيرة عند إنجاز عملي) في المرتبة الأخيرة، من بين جميع فقرات هذا البُعد، بمتوسط حسابي (2.23) وانحراف معياري (1.014)، بدرجة موافقة منخفضة، ونلاحظ أن تقييم مستوى أفراد عينة الدراسة حول هذا البعد كان منخفض ومتوسط وبانحرافات صغيرة لأغلب الفقرات، مما يشير الى عدم تشتت اتجاهات مفردات عينة الدراسة، وأخيراً بلغ المتوسط الحسابي العام لبُعد الإمام بالأداء الوظيفي (2.42) وبانحراف معياري (0.934)، ويدل على أن مستوى الإمام بالأداء الوظيفي كمؤشر لأداء الخدمة كان منخفضاً، حسب المقياس المعتمد في الدراسة.



الجدول رقم (3) تحليل الانحدار الخطي لإيجاد الأثر لبرامج التدريب في الإمام بالأداء الوظيفي

البيان	معامل الارتباط R	معامل التحديد R <sup>2</sup>	اختبار F	مستوى المعنوية المشاهد	القرار
الأثر لبرامج التدريب في الإمام بالأداء الوظيفي	0.838	0.702	230.382	0.000	قبول الفرضية

المصدر: الدراسة الميدانية

يتضح من الجدول السابق أن قيمة معامل الارتباط تساوي (0.838) بإشارة موجبة، وهذا يدل بأن العلاقة بين (برامج التدريب) و(الإمام بالأداء الوظيفي) طردية، أي كلما زاد الاهتمام (ببرامج التدريب) زاد معها مستوى (الإمام بالأداء الوظيفي) (والعكس صحيح)، كما أن معامل التحديد (R<sup>2</sup>) يساوي (0.702)، مما يعني أن برامج التدريب مسؤولة عن تفسير (70.2%) من التغيرات التي تحدث في (الإمام بالأداء الوظيفي)، وأن ما نسبته (29.8%) يرجع لعوامل أخرى، بالإضافة إلى حد الخطأ العشوائي.

وحيث أن قيمة (F) المشاهد تساوي (230.382) بمستوى دلالة وهي (0.000)، أقل من (0.05)، وهذا يشير إلى أن النموذج معنوي في تفسير العلاقة وقياس الأثر، مما يعني إمكانية الاعتماد على معادلة الانحدار، وكذلك إمكانية تعميم النتائج على المجتمع محل الدراسة.

وبالتالي تقبل فرضية الدراسة التي تنص على: يوجد أثر ذو دلالة إحصائية لبرامج التدريب في الإمام بالأداء الوظيفي بالفندق قيد الدراسة.

## 6.1 النتائج والتوصيات

### 1.6.1 النتائج

1. أن المتوسطات الحسابية لبعدها التدريب (2.57)، بمستوى منخفض.
2. أن المتوسط الحسابي للفقرة تضع الشركة برامج تدريبية بصفة دورية ومستمرة كان منخفضاً..
3. أن المتوسط الحسابي للفقرة تحقق البرامج التدريبية الأهداف الموضوعية لأجلها كان منخفضاً.
4. أن المتوسط الحسابي للفقرة يتوافق محتوى البرامج التدريبية مع متطلبات الوظيفة التي تعمل بها منخفضاً.
5. أن المتوسط الحسابي لأغلبية الفقرات بعنصر الإمام بالأداء الوظيفي كان منخفضاً.
6. يوجد أثر ذو دلالة إحصائية لبرامج التدريب في الإمام بالأداء الوظيفي بالفندق قيد الدراسة

### 2.6.1 التوصيات



ATLAS 11. INTERNATIONAL  
CONGRESS ON ADVANCED SCIENTIFIC STUDIES AND INTERDISCIPLINARY RESEARCH

1. الاهتمام بالتدريب للموظفين بفندق باب البحر بطرابلس بالشكل المطلوب، كون ان له أثر كبير في تحسين الاداء الوظيفي.
2. تصميم برامج تدريبية بصفة دورية ومستمرة، وأن تحقق البرامج التدريبية الأهداف الموضوعية لأجلها، مما يساهم في تغطية جوانب العجز في الأداء الوظيفي للعاملين.
3. العمل على توفير بيئة تدريبية مناسبة، وأن يتم متابعة سير عملية التدريب من قبل إدارة التدريب بالشركة، باستخدام الوسائل التعليمية الملائمة لطبيعة البرنامج التدريبي.
4. العمل على تطوير مهارات العاملين من خلال إقامة دورات تدريبية لزيادة مهاراتهم ومعرفهم، وأن تتناسب البرامج التدريبية التي يحصل عليها العاملين مع طبيعة أعمالهم، وذلك للرفع من كفاءة العاملين مما يساهم في تحسين أدائهم.
5. توفير مدربين ذو خبرة وتخصص، وأن يكون لهم القدرة على إدارة المناقشات والمداخلات أثناء عملية التدريب ، والاعتماد على طرق ووسائل متنوعة في عملية التدريب.
6. الاهتمام بالمتدربين من خلال منح جميع الموظفين فرص تدريب متكافئة، وإخضاعهم لدورات تدريبية عند وجود نقص في أدائهم، فالتدريب المكثف والمستمر يساعد على تحسين أداء الموظفين.
7. تحسين أداء الخدمة من خلال نشر ثقافة الإلمام بالأداء الوظيفي، وتحسين مستوى الاداء الوظيفي بالجودة العالية، وإنجاز العمل بالسرعة والدقة المطلوبة.
8. تدريب العاملين يحفز العاملين الاعتماد على أنفسهم لأداء أعمالهم من تفويض السلطة وتحمل المسؤولية.

#### 7.1 المصادر

- أبو النصر، مدحت ، 2008، إدارة العملية التدريبية، النظرية والتطبيق، القاهرة، دار الفجر للنشر والتوزيع، الطبعة الأولى.
- بلوط حسين إبراهيم، 2002، إدارة الموارد البشرية من منظور استراتيجي، بيروت، دار النهضة العربية.
- الطعاني ، حسين أحمد ، 2013، التدريب الإداري وفق الرؤية التطويرية، دار وائل للنشر والتوزيع، عمان، الأردن.
- العساف، عبدالله، 2008، المركزية واللامركزية بالأداء الوظيفي، رسالة ماجستير غير منشورة، جامعة الرياض، السعودية.
- سهيلة عباس، 2003، إدارة الموارد البشرية، مدخل استراتيجي، دار وائل للنشر والتوزيع، عمان، الأردن.
- عبد الباقي، صلاح الدين محمد، 2000، الاتجاهات الحديثة في إدارة الموارد البشرية، الدار الجامعية، الاسكندرية.



ATLAS 11. INTERNATIONAL  
CONGRESS ON ADVANCED SCIENTIFIC STUDIES AND INTERDISCIPLINARY RESEARCH

---

- <http://ar.wikipedia.org>
- <http://mawdoo3.com>
- <http://www.annajah.net>





## ORTA YOĞUNLUKLU LİFLİ LEVHA TOZUNDAN YÜKSEK SELÜLOZ İÇERİKLİ ÜRÜN ELDESİ İÇİN ORGANOSOLV YÖNTEMİNİN UYGULANMASI

APPLICATION OF ORGANOSOLV METHOD TO OBTAIN HIGH CELLULOSE  
CONTAINING PRODUCT FROM MEDIUM DENSITY FIBERBOARD POWDER

**Arş. Gör. Kübra İNÇ**

Fırat Üniversitesi

ORCID: 0000-0003-1470-9937

**Prof. Dr. H. Soner ALTUNDOĞAN**

Fırat Üniversitesi

ORCID: 0000-0003-3328-9667

### ÖZET

Lignoselülozik biyokütle, dünyada en bol miktarda bulunan ve sürdürülebilir bir hammaddedir. Biyokütlenin değerli ürünlerin üretimi amacıyla kullanılması noktasında lignin, selüloz ve hemiselüloz gibi temel biyokütle bileşenlerinin biyorafineri konseptiyle elde edilmesi, çevresel ve ekonomik açılarından en verimli yöntemdir. Ancak, prosesin endüstriyel bağlamda kabul edilebilirliğini artırmak için daha ekonomik, insan ve çevre sağlığını daha çok gözetilen bir yaklaşımla gerçekleştirilecek üretim yöntemlerinin ortaya konması önem arz etmektedir.

Bu çalışmada, mobilya sanayinde büyük miktarlarda endüstriyel bir atık olarak elde edilen ve çeşitli çevresel problemlere de neden olabilen orta yoğunluklu lifli levha (MDF) tozuna, nispeten saf bir selüloz elde etmek amacıyla organosolv ön işleme uygulanmıştır. Yapılmış olan bu çalışma ile değerlendirilmesi güç bir artık olan MDF tozundan, hem selüloz elde edilmiş hem de daha çevreci bir yöntemle, var olan bu atık giderme problemine alternatif bir çözüm sağlanmıştır. Öncelikli olarak kullanılan MDF tozunun kimyasal karakterizasyonu amacıyla bazı analizler yapılmıştır. Bu analizler arasında MDF'nin nem, uçucu madde, kül ve sabit karbon analizleri olan yaklaşık analizleri ve ayrıca lignin, selüloz, hemiselüloz ve ekstraktif madde gibi biyokütle analizleri yer almaktadır.

Nem miktarı % 4,62, uçucu madde miktarı % 78,8, kül miktarı % 0,93 ve sabit karbon miktarı % 15,65 olarak belirlenmiştir. Biyokütle analiz sonuçları ise yaklaşık olarak lignin % 23, selüloz % 37, hemiselüloz % 32 ve ekstraktif madde % 8 olarak belirlenmiştir. Organosolv çalışmaları karıştırılmalı basınçlı bir reaktörde ve çözücü olarak etil alkol çözeltileri ile gerçekleştirilmiştir. MDF tozundan yüksek verimde selüloz elde edebilmek için ise sıcaklık, alkol konsantrasyonu, partikül boyutu, katalizör tipi gibi değişkenler incelenmiştir. Yapılan



çalışmalar neticesinden selüloz oranının en yüksek olduğu değerler baz alınarak en iyi şartların, 120 °C sıcaklık, % 60 alkol oranı, 0,01 M NaOH katalizörü konsantrasyonu, 1:10 katı/sıvı oranı, -75 mesh numune boyutu ve 60 dk işlem süresi olduğu belirlenmiştir.

**Anahtar Kelimeler:** Organosolv, MDF, Biyokütle, Selüloz, Hemiselüloz, Lignin.

## ABSTRACT

Lignocellulosic biomass is the most abundant and sustainable raw material in the world. At the point of using biomass for the production of valuable products, obtaining basic biomass components such as lignin, cellulose and hemicellulose with the biorefinery concept is the most efficient method in terms for environmental and economic aspects. However, in order to increase the acceptability of the process in the industrial context, it is important to introduce production methods that are more economical and more protective of human and environmental health.

In this study, organosolv pre-treatment was applied to medium density fibreboard (MDF) powder, which is obtained as an industrial waste in large amounts in the furniture industry and can cause various environmental problems, in order to obtain a relatively pure cellulose. With this study, cellulose was obtained from MDF powder, which is a residue that is difficult to evaluate, and an alternative solution to this existing waste removal problem was provided with a more environmentally friendly method. Some analyzes were made primarily for the chemical characterization of the MDF powder used. These analyzes include approximate analyzes of MDF, namely moisture, volatile matter, ash and fixed carbon analyses, as well as biomass analyzes such as lignin, cellulose, hemicellulose and extractive matter.

The average amount of moisture was determined as 4.62 %, the amount of volatile matter was 78.8 %, the amount of ash was 0.93 % and the amount of fixed carbon was 15.65 %. Biomass analysis results were calculated as approximately lignin 23 %, cellulose 37 %, hemicellulose 32 % and extractive substance 8 %. Organosolv studies were carried out in a stirred pressurized reactor with ethyl alcohol solutions as solvent. In order to obtain high yield of cellulose from MDF powder, variables such as temperature, alcohol concentration, particle size, and catalyst type were examined. As a result of the studies, it was determined that the best conditions, based on the values with the highest cellulose ratio, were 120 °C temperature, 60 % alcohol content, 0.01 M NaOH catalyst concentration, 1:10 solid/liquid ratio, -75 mesh sample size and 60 min processing time.

**Key Words:** Organosolv, MDF, Biomass, Cellulose, Hemicellulose, Lignin.



## **BIOCHEMICAL BALLET OF SOURDOUGH WITH MICROBIOTA: METABOLIC AND NUTRITIONAL PERSPECTIVES ON FOOD QUALITY AND HEALTH**

**Marwa TAINSA**

Ph.D. Student, Saad Dahleb University

ORCID NO: 0009-0004-6377-7332

**Assist. Prof. Dr. İsmail Hakkı TEKİNER**

Istanbul Sabahattin Zaim University, Nutrition and Dietetics Department and Food

Engineering Department

ORCID NO: 0000-0002-7248-2446

### **ABSTRACT**

Sourdough and sourdough technology have been widely used for bakery products and bread-making for thousands of years. In modern times, Spicker and the Spanish group “Benedito de Barber” first conducted a comprehensive investigation on sourdough in 1971. Sourdough is a mixture of flour and water that undergoes spontaneous fermentation under certain circumstances by lactic acid bacteria and yeasts, leading to significant organoleptic characteristics, i.e., unique flavours, extended shelf lives, and nutritional benefits. The complicated microbial ecosystem of sourdough mainly determines its critical quality properties in interaction with some conditions, including nutrients, carbohydrates, pH, redox potential and oxygen tension. In sourdough, lactic acid bacteria are mainly the fundamental biological species, and their metabolic activities during fermentation directly affect the overall quality of food, for instance, by generating some bio-preservative metabolites to inhibit the growth of pathogens and spoilage microorganisms. Additionally, the bio-preservative characteristics of LABs also play a crucial role in maintaining the integrity of sourdough by enhancing its nutritional profile and preventing bread flaws. This review aims to evaluate the biochemical ballet of sourdough with microbiota from metabolic and nutritional perspectives on food quality and health.

**Keywords:** Sourdough, Fermentation, Lactic Acid Bacteria, Yeast, Nutrition, Health



## OKUL ÖNCESİ DÖNEMDE ELEŞTİREL DÜŞÜNME BECERİLERİNİN GELİŞTİRİLMESİ

DEVELOPMENT OF CRITICAL THINKING SKILLS IN PRESCHOOL PERIOD

**Dr. Bahar YAKUT ÖZEK**

Milli Eğitim Bakanlığı, Ankara, Türkiye

ORCID ID: 0000-0001-7699-8741

### ÖZET

Okul öncesi dönem, çocuğun bilişsel ve akademik gelişiminde temel bir evredir. Bu önemli evrede, eğitimciler ve bakıcılar, çocuğun gelecekteki akademik başarısının temelini oluşturan becerilerin geliştirilmesinde kilit bir rol üstlenirler. Bu beceriler arasında eleştirel düşünmenin geliştirilmesi büyük önem taşımaktadır. Özellikle, çocukların doğru bir şekilde sorgulama yapabilme, bilgiyi eleştirel bir gözle değerlendirme ve mantıklı sonuçlara ulaşma becerilerini kazanmaları büyük önem taşır. Bu beceriler arasında eleştirel düşünme, çocuklara dünyayı derinlemesine anlama ve çeşitli konularda bilinçli kararlar alma yeteneği kazandırmada önemli bir düşünsel araçtır. Bu makale de okul öncesi dönemde eleştirel düşünme becerilerini geliştirmenin önemini ele almakta, eğitimcilerin ve ebeveynlerin uygulayabileceği etkili stratejileri araştırmayı amaçlamaktadır. Bu bağlamda araştırmanın metodolojisi doküman analizi üzerine kurgulanmıştır. Okul öncesi öğrencilerin eleştirel düşünmesi üzerine ilgili alanyazın taranmış, konu ile ilgili araştırmanın amacına yönelik elde edilen bilgiler analiz edilerek derleme şeklinde sunulmuştur. Bu kapsamda ortaya çıkan başlıklar; eleştirel düşünme tanımı ve erken çocukluk döneminde öğrencilerin gelişimindeki etkisi, merakı teşvik etme, oyun temelli öğrenme, analitik becerilerin geliştirilmesi, hikaye anlatma becerileri ile neden-sonuç ilişkisi içerisinde düşünme becerisi kazandırma, düşünmeyi teşvik eden destekleyici ortamlar ve etkinlikler oluşturma şeklindedir. Okul öncesi dönemde çocukların eleştirel düşünme becerileri bu başlıklar altında tartışılmış, eğitimciler ile ebeveynlerin arasındaki işbirliğinin çocukların düşünsel becerilerinin gelişimine bütünsel bir yaklaşım sunacağına vurgu yapılmıştır. Araştırmanın sonucunda, okul öncesi dönemin, çocukların eleştirel düşünme becerilerini geliştirerek çocuğun bilişsel yapısını olumlu yönde şekillendirmede önemli bir fırsat sunduğu bulgusuna ulaşılmıştır. Öğretmenler ve ebeveynler, araştırmaya, düşünmeye ve sorgulamaya yönelik etkinliklerle ve ev ortamında da bunun destekleneceği ortamların oluşturulmasıyla, çocuğun yaşam boyu sürdüreceği analitik düşünme ve muhakeme kabiliyetlerinin sağlam bir temelini oluşturabilirler.

**Anahtar Kelimeler:** Okul öncesi dönem, erken çocukluk eğitimi, eleştirel düşünme, eleştirel düşünme becerileri, öğretmen-ebeveyn işbirliği



## ABSTRACT

Preschool period is a fundamental phase in the child's cognitive and academic development. During this important phase, educators and caregivers play a key role in developing the skills that underpin the child's future academic success. Among these skills, the development of critical thinking is of great importance. In particular, it is very important for children to acquire the skills to question correctly, evaluate information critically and reach logical conclusions. Among these skills, critical thinking is an important intellectual tool in providing children with a deep understanding of the world and the ability to make informed decisions on various issues. This article discusses the importance of developing critical thinking skills in the preschool period and aims to investigate effective strategies that educators and parents can apply. In this context, the methodology of the research is based on documental analysis. The relevant literature on critical thinking of preschool students was scanned, and the information obtained for the purpose of the research on the subject was analyzed and presented in the form of a compilation. The headlines that emerged in this context are; The definition of critical thinking and its impact on the development of students in early childhood is encouraging curiosity, game-based learning, developing analytical skills, gaining thinking skills in a cause-effect relationship with storytelling skills, and creating supportive environments and activities that encourage thinking. The critical thinking skills of children in the preschool period were discussed under these headings, and it was emphasized that the cooperation between educators and parents would provide a holistic approach to the development of children's intellectual skills. As a result of the research, it was found that the preschool period offers an important opportunity to shape the child's cognitive structure in a positive way by developing children's critical thinking skills. Teachers and parents can create a solid foundation for the child's lifelong analytical thinking and reasoning abilities through activities aimed at researching, thinking and questioning, and by creating environments that support this at home.

**Key Words:** Preschool period, early childhood education, critical thinking, critical thinking skills, teacher-parent cooperation.



## **SUSTAINABLE DEVELOPMENT: CHALLENGES AND STRATEGIES IN SOUTH ASIA, SPOTLIGHTING PAKISTANI HIGHER EDUCATION**

**Zohaib Hassan SAIN**

Superior University, Faculty of  
Business & Management Sciences,  
Lahore, Pakistan.

### **ABSTRACT**

This study analyzes the pursuit of Sustainable Development Goals (SDGs) across South Asia, highlighting socio-economic and political impediments. Through data and analysis of key SDGs like poverty (1), health (3), education (4), and economic growth (8), it underscores the urgency for substantial action. The study advocates for a pivotal role from Developed Countries (DCs), proposing at least 1% of GNP in development aid and knowledge sharing with Under Developed Countries (UDCs) to improve governance and facilitate structural reforms. The findings guide South Asian nations in crafting effective economic policies for achieving SDGs by 2030. Additionally, the research explores Education for Sustainable Development (ESD) in Pakistani Higher Education Institutions, revealing both progress and challenges. It emphasizes stakeholder collaboration (administrators, leaders, teachers, students) and the importance of good governance, communication, coordination, and campus outreach in addressing sustainability challenges. Aligning logistical support with quality education (SDG 4) is crucial for SDG attainment. This study serves as a resource for educators, policymakers, and curriculum developers, and aids researchers in formulating questions for future SDG endeavors.

**Keywords:** Developed Countries, Quality Education, SDGs, Under Developed Countries.



## THE INTEGRATION OF ARTIFICIAL INTELLIGENCE FOR HIGHER EDUCATION ADVANCEMENT IN PAKISTAN

**Zohaib Hassan SAIN**

Superior University, Faculty of  
Business & Management Sciences,  
Lahore, Pakistan.

### **ABSTRACT**

Higher education has always been accompanied by challenges for professors and educators. However, technological advancements have also brought forth various opportunities in the form of educational aids. This study explores the opportunities and challenges of using ChatGPT and virtual assistants in higher education in Pakistan. Among these technologies, artificial intelligence (AI) has emerged as a transformative force, offering both opportunities and challenges. This paper delves into the application of AI-based tools, particularly ChatGPT and virtual assistants, in higher education advancement in Pakistan. It discusses the potential benefits and obstacles associated with their use, while also presenting and analyzing research findings on the utilization of ChatGPT by students in a higher education setting. The study highlights the advantages that ChatGPT and virtual assistants can bring to the learning process, such as personalized assistance and access to information. However, it also acknowledges the challenges, including the need for effective implementation and addressing privacy concerns. By examining the opportunities and challenges associated with these AI-driven tools, this study contributes to a better understanding of their role in enhancing higher education in Pakistan and provides insights for educators and policymakers in leveraging these technologies effectively.

**Keywords:** Artificial Intelligence; Challenges; Chatbots; Higher Education; Virtual Assistants.



## ŞAGİRD LƏRİN BİOLOGİYANIN TƏDRİSİNDƏ ELEKTRON DƏRSLİKLƏRLƏ İŞİN TƏŞKİLİ PRİNSİPLƏRİ

### PRINCIPLES OF ORGANIZATION OF WORK WITH ELECTRONIC TEXTBOOKS IN TEACHING BIOLOGY TO STUDENTS

**Doç. Dr. Gafarova Parvin MUHAMAD**  
Azərbaycan Dövlət Pedaqoji Universitetinin  
Biologiya və onun tədrisi texnologiyası kafedrasının  
dosenti Gafarova Parvin Muhamad  
Azərbaycan, Bakı  
ORCID ID 0009-0002-9696-3540

#### XÜLASƏ

Elektron dərsliklərin təlim prosesində istifadə edilməsi tərəf müqabili kimi müəllimlə şagird və şagirdlə şagird arasında əməkdaşlıq münasibətlərinin yaradılmasına yardımçı olur. Bununla şagirdlər öz fəaliyyətlərində potensial imkanlarından istifadə etmək hüququ qazanır, çəkinmədən istənilən fikri müstəqil söyləyə bilir və onlarda özünə inam artır. Belə ki, qrupların təşkil olunması ilə aparılan təlim zamanı əməkdaşlıq münasibətləri aydınlaşır. Qrupda olan şagirdlər oxuduqları mətni müzakirə edir, müxtəlif fərziyyə və baxışlar nəzərdən keçirir, öyrəndiklərini analiz edir, ümumiləşdirir və təqdimat üçün öz aralarından kimisə seçirlər. Lakin bu halda belə qrup üzvləri müəllimlə birlikdə təqdimat prosesində müzakirəyə qoşulur və birlikdə nəticə çıxarırlar. Sonra şagirdlərin bilikləri möhkəmləndirilir və onların biliklərini müəyyənləşdirmək üçün test sualları verilir və şagirdlərin testlərə verdiyi cavablar müəyyənləşdirilir, şagirdlərin biliklərinin qiymətləndirilməsi prosesi başlayır. Bu prosesdə şagirdlər həm özlərini, həm də yoldaşlarının qiymətləndirilməsində iştirak edirlər.

Biologiya tədrisində elektron dərsliklərlə işin təşkili prinsipləri müxtəlif təhsil müəssisələri və müəlliflər tərəfindən müxtəlif olur. Ancaq, geniş şəkildə, elektron dərsliklərin təşkilatında və tədrisində aşağıdakı prinsiplər əsas rol oynayır:

1. **İnteraktivlik:** Elektron dərsliklər interaktiv olmalıdır. Tədris materialının tərkibində video, təqdimatlar, animasiyalar, və interaktiv tapşırıqlar kimi müxtəlif multimedia elementlər yer almalıdır.
2. **Əlaqəlilik:** Dərsliklər müxtəlif mövzular arasında quraşdırmaq üçün mümkün qədər əlaqəli və tətbiqi olmalıdır. Real həyat təcrübələri və günlük həyatla əlaqəli nümunələr tədris materialında geniş yer tutmalıdır.
3. **Məşğulluq və tətbiqatlar:** Elektron dərsliklər tədris materialını tətbiq etmək və məşğulluqları özündə əhatə etmək üçün tətbiqi və maraqlı məşğulluqlar təqdim etməlidir. Bioloji konseptləri laboratoriyaya tətbiqləri, sanal laboratoriyalar və ya animasiyalar vasitəsilə təqdim edilə bilər.





4. Təcrübəyə əsaslanan tədris: Təcrübəyə əsaslanan tədris metodu tətbiqi, tədqiqat, və müstəqil öyrənməni təşvik etməli və təmin etməlidir. Öyrəncilər müstəqil olaraq məlumatları almağa nail olmalıdırlar.
5. Adaptiv tədris: Elektron dərsliklər müxtəlif öyrənci bacarıqlarına və təcrübələrinə uyğun olmalıdır. Adaptiv tədris metodu, öyrəncilərə fərqli təlimatlar verərək hər birinin öz tempində öyrənməsinə imkan verir.
6. Rəqəmsal təcrübə və simulyasiyalar: Bioloji prosesləri və tədqiqatlar rəqəmsal təcrübə və simulyasiyalar vasitəsilə öyrəncilərə təqdim edilə bilər. Bu, öyrəncilərə abstrakt konseptləri daha yaxşı başa düşməkdə və məlumatları daha effektiv şəkildə öyrənməkdə kömək edir.
7. Müstəqil öyrənmə imkanları: Elektron dərsliklər öyrəncilərə müstəqil öyrənmə imkanları təqdim etməlidir. Özü öyrənməyə və tədqiqat etməyə nail olmaq üçün özünü sınaşmaq və təşkil etmək üçün vəzifələr və tapşırıqlar olmalıdır.

Bu prinsiplər özünü tədris üçün ideal bir elektron dərslik tətbiq etmək üçün istifadə edilə bilər və tədrisin effektivliyini artırır.

*Açar sözlər:* tədris, electron dərslik, şagird, müəllim, sinif

## ABSTRACT

The use of electronic textbooks in the educational process helps to create cooperative relations between the teacher and the student and the student and the student. In this way, students gain the right to use their potential in their activities, they can express any opinion independently without hesitation, and their self-confidence increases. Thus, cooperative relations are clarified during the training conducted with the organization of groups. The students in the group discuss the text they read, consider different hypotheses and views, analyze and summarize what they have learned and choose someone from among themselves for the presentation. However, in this case, group members join the discussion with the teacher in the presentation process and draw conclusions together. Then the students' knowledge is reinforced and test questions are given to determine their knowledge, and the students' answers to the tests are determined, and the process of evaluating the students' knowledge begins. In this process, students participate in the assessment of themselves and their peers.

The principles of organizing work with electronic textbooks in teaching biology vary by different educational institutions and authors. However, broadly speaking, the following principles play a key role in the organization and teaching of electronic textbooks:

1. Interactivity: E-textbooks should be interactive. Teaching materials should include various multimedia elements such as videos, presentations, animations, and interactive exercises.

2. Relevance: Textbooks should be as relevant and applicable as possible to fit across



different topics. Real-life experiences and examples related to everyday life should be widely included in the teaching material.

3. Activities and applications: E-textbooks should provide practical and interesting activities to apply the learning material and include activities. Biological concepts can be presented through laboratory applications, virtual laboratories or animations.

4. Experiential learning: An experiential learning method should encourage and enable application, inquiry, and independent learning. Students should be able to acquire information independently.

5. Adaptive learning: E-textbooks should be adapted to different learner skills and experiences. Adaptive learning provides differentiated instruction to students, allowing each student to learn at their own pace.

6. Digital experiments and simulations: Biological processes and research can be presented to learners through digital experiments and simulations. It helps learners better understand abstract concepts and learn information more effectively.

7. Independent learning opportunities: E-textbooks should provide learners with independent learning opportunities. To achieve self-learning and research, there should be tasks and assignments to challenge and organize oneself.

These principles can be used to implement an e-textbook ideal for self-study and increase the effectiveness of teaching.

**Key words:** education, electronic textbook, student, teacher, class

Güclü inkişaf dövründə kompüter texnologiyalarının təlimdə səmərəli nəticə verməsi üçün təlimin məzmununun, metod, prinsip və vasitələrinin müasir tələblərə uyğunlaşdırılması ilə yüksək keyfiyyət əldə edilə bilər. Müasir tələblərdən biri də təlim prosesində elektron dərsliklərdən istifadənin həyata keçirilməsi prinsiplərini müəyyənləşdirməkdir. Bunun üçün isə elektron dərsliklərin təlimdə rolu aydınlaşdırılmalıdır. Bu dərsliklər şagirdlərin bilik və bacarıqlarının qloballaşdırılmasına, elmi-metodik hazırlığın inkişafına yeni imkanlar açır. Eyni zamanda yeni təlim texnologiyasının bütün problemlərinin, o cümlədən nəzəri və praktik məsələlərin həllində, şagirdlərin elmi dünyagörüşünün, ümumi mədəni və əxlaqi dəyərlərin formalaşdırılmasında əsas rol oynayır. Ümumtəhsil məktəblərinin 6-11-ci sinifləri üçün hazırlanmış audiovizual dərs vəsaitlərində şagirdlər üçün dərslikdə olmayan yeni elmi biliklər, əlavə məlumatlar, terminlər lüğəti, biologiyanın inkişafında xidmətləri olan tarixi şəxsiyyətlər haqqında məlumatlar verilmişdir. Eyni zamanda şagirdlərin bilik və bacarıqlarını üzə çıxartmağa xidmət edən test sualları işlənmişdir. Vəsaitdə çoxlu hərəkətli şəkillərin, videofraqmentlərin, animasiyaların olması onun digər vəsaitlərdən üstünlüyüdür. Mövzular üzrə bioloji terminlərin izahlı lüğəti, yoxlama test suallarının verilməsi, laboratoriya və praktik məşğələlərin aparılmasına dair videofraqmentlərin olması şagirdlərin müstəqilliyinin artmasına, praktik bilik və bacarıqların formalaşmasına, tədqiqatçılıq bacarıqlarının yaranması və inkişafına əsaslı təsir göstərir. Elektron dərs vəsaitlərində şagirdlərin apara biləcəkləri laboratoriya və praktik işlərin təşkilinə də xüsusi yer ayrılmışdır[1]. Şagirdlərin əsas diqqəti



mühüm və aparıcı ideyalara, bioloji anlayış, termin, qanunların və proseslərin şərhinə, faktik biliklərin mənimsənilməsinə yönəldilmişdir. Elektron tədris vəsaiti əsas dərsləyə uyğun olaraq işlənmiş, onu daha da zənginləşdirmişdir. Yeni ölavələrə malik olmaqla dərsləyi əsaslı dərəcədə tamamlayır, istənilən tərəfdən onun başa düşülməsinə şərait yaradır. Mövzunun tam izahından sonra müəllim şagirdlərlə müsahibə apararaq onların mənimsəmə keyfiyyətini yoxlamaq imkanına malik olur. Bunun üçün testlərdən istifadə edir.

Bir kompüter olan siniflərdə isə elektron dərsləklərdəki görüntüləri bütün şagirdlərin görməsi və eşitməsi üçün müəllim lazımı materialları proyektor vasitəsilə lövhəyə verir və beləliklə, bütün şagirdlərə mövzunun öyrənilməsi üçün şərait yaradır. Dərsləin sonunda müəllim test nümunələrini lövhədə canlandıraraq onları həll etməyi tapşırır. Şagirdlər testləri cavablandırır və kompüterin cavabları ilə müqayisə edərək səhvlərini aşkara çıxarırlar.

Bütün bunları həyata keçirmək üçün müəllim əvvəlcədən mövzu ilə yaxından tanış olur, elektron dərsləkdə onunla bağlı bütün məlumatları öyrənir, dərslədə istifadə edəcəyi hissənin yerini aydınlaşdırır və istifadə üçün hazır vəziyyətə gətirməlidir. Mövzuya uyğun şagirdlərin müstəqil işləməsi üçün əvvəlcədən plan hazırlanır, plan əsasında dərslə qurulur, sinifdəki təlim şəraiti, şagirdlərin bilik və bacarıqları nəzərə alınır[2]. Elektron dərsləklərdən bu şəkildə istifadə ediləkdə təlimin keyfiyyəti və şagirdlərin fəallığı yüksəlir. Bütün bu deyilənlərdən görünür ki, elektron dərsləklərlə işləyərkən şagirdlərin fəallığı xeyli artır, bu da fəal təlim metodlarının tələb etdiyi ən mühüm şərtlərdən biridir. Fəal təlim metodları müasir təlimin prinsiplərinin həyata keçirilməsinə xidmət edir. Elektron dərsləklərin məktəblərdə tətbiqi də bu prinsiplərlə uzlaşır. Belə ki, təlim prosesində elektron dərsləklərlə işlərkən şagirdlərin fərdi cəhətlərinin nəzərə alınması, bütün diqqətin onların maraq və tələbatlarına, bilik səviyyələrinə, imkan və qabiliyyətlərinə yönəldilməsi, onlarla səmimi münasibətə səy göstərilməsi fəal təlim metodlarının əsas prinsiplərindən biri olan şagirdlərin dünyanı müstəqil dərk edən şəxsiyyət kimi formalaşmasında mühüm rol oynayır.

Təlimdə şagirdlər zəruri olan informasiyanı müstəqil işləmək və ondan ağıllı istifadə etmək bacarıqlarına yiyələnir. Bunun üçün dərslədə şagirdlərə elektron dərsləklərlə sərbəst işləmək və mürəkkəb tapşırıqları müstəqil həll etmək üçün şərait yaradılır. Müəllim hər bir şagirdə fərdi yanaşır, dərsləkdən və elektron dərsləkdən (görmə, eşitmə, hiss etmə duyğularına əsaslanan) istifadə etməklə onlara mövzu ilə bağlı məlumatları toplamaq və onları mənimsəmək haqqında tapşırıq verir. Bu tapşırıqların yerinə yetirilməsi şagirdlərin verilən şəraitə uyğunlaşmasına, qazandıqları biliklərin daha çox yaradıcı olmasına və lazımı sahəyə tətbiq etmək bacarığına nail olmaq səviyyəsinə gətirir. Ona görə də müəllim özü dərslədən əvvəl müxtəlif bilik mənbələrindən, əsas dərsləkdən mövzunu dərinləndirən öyrənir. Məlumatı təqdim etmə formalarından olan elektron dərsləkdən mövzunun mətni, laboratoriya işləri ilə bağlı fraqmentlər, təcrübələr, animasiya və şəkillərə baxır ki, tədrisdə bundan mövzunun izahının hansı hissəsində və necə istifadə edəcəyi haqda şagirdləri düzgün istiqamətləndirsin.

Elektron dərsləklərlə işlədikdə müəllim əvvəlcədən yeni mövzu ilə bağlı bir neçə ziddiyyətli və yarımçıq formada sual hazırlayır ki, şagirdlər problemlə situasiyalarla qarşılaşsınlar, cavabların tapılması və sualların tamamlanması üçün yeni biliklərə yiyələnməyə həvəslənsinlər və onlarda idrak fəallığı artsın. Elektron dərsləkdən istifadə zamanı hansı bölmədə buna nail olacaqları üçün axtarışda olsunlar. Bu cür vəziyyətin yaradılması ilə müəllim



şagirdləri qarşıya qoyulmuş məqsədə nail olmaq yollarını axtarmağa sövq edir. Onlar tədqiqat prosesində problemləri müstəqil həll etməyə çalışır, bir növ tədqiqatçı rolunu oynayırlar və bununla da onların təfəkkürü fəallaşır. Prosesin sonu şagirdlərin fəallığının artması ilə nəticələnir. Beləliklə, “Problemin qoyulması- Təfəkkürün fəallaşması- Şagirdlərin fəallığı” prinsipi həyata keçirilir.

Elektron dərsliklərin təlim prosesində istifadə edilməsi tərəf müqabili kimi müəllimlə şagird və şagirdlə şagird arasında əməkdaşlıq münasibətlərinin yaradılmasına yardımçı olur. Bununla şagirdlər öz fəaliyyətlərində potensial imkanlarından istifadə etmək hüququ qazanır, çəkinmədən istənilən fikri müstəqil söyləyə bilir və onlarda özünə inam artır. Belə ki, qrupların təşkil olunması ilə aparılan təlim zamanı əməkdaşlıq münasibətləri aydınlaşır. Qrupda olan şagirdlər oxuduqları mətni müzakirə edir, müxtəlif fərziyyə və baxışlar nəzərdən keçirir, öyrəndiklərini analiz edir, ümumiləşdirir və təqdimat üçün öz aralarından kimisə seçirlər. Lakin bu halda belə qrup üzvləri müəllimlə birlikdə təqdimat prosesində müzakirəyə qoşulur və birlikdə nəticə çıxarırlar[3]. Sonra şagirdlərin bilikləri möhkəmləndirilir və onların biliklərini müəyyənləşdirmək üçün test sualları verilir və şagirdlərin testlərə verdiyi cavablar müəyyənləşdirilir, şagirdlərin biliklərinin qiymətləndirilməsi prosesi başlayır. Bu prosesdə şagirdlər həm özlərini, həm də yoldaşlarının qiymətləndirilməsində iştirak edirlər. Dərsin sonunda şagirdlərdən hər kəs ayrılıqda özünü və qarşılıqlı surətdə bir-birini qiymətləndirirlər. Bu mərhələdə hərə özünün və tərəf müqabilinin buraxdığı səhvləri, anlaşılmayan məqamları görür, üzə çıxarırlar. Bu halda müəllimin qiyməti onun şəxsi fikrini əks etdirmir. Şagirdlərin müxtəlif nöqtəyi-nəzərlərinin və fikirlərinin nəzərə alınması, bir-birinin səhvlərini düzəltməsi qiymətləndirmə prosesində mühüm rol oynayır. Hətta müəllim şagirdlərin biliyi dəyərləndirmək qabiliyyətini üzə çıxarır.

Bu tip dərslərdə şagirdlərə axtarıclıq qabiliyyətini və elmi dünyagörüşlərini artırmaq, elmin əsaslarını daha da dərinlən öyrənmək üçün əldə etdikləri məlumatları toplamaq və gələcəkdə onlardan bəhrələnmək kimi keyfiyyətlər aşılır. Elektron dərsliklərində olan əlavələrin mahiyyəti izah edilir, yeni terminlər, anlayışlar, bioloji proseslər, kəşflər və s. haqqında məlumatlar şagirdlər tərəfindən xüsusi dəftərdə qeyd edilir. Həmin qeydlər şagirdlərə diqqətlik, səliqəlilik xüsusiyyətləri aşılayır, onlarda elmə və təbiət hadisələrinə marağı artırır, həmçinin yaddaşın təzələnməsinə kömək edir.

Mövzuların tədrisində fəndaxili əlaqə ilə yanaşı fənlərarası əlaqə də yaradılmalıdır. Fənlərarası əlaqənin yaradılması tədrisin səmərəliliyini, effektivliyini yüksəldir, şagirdlərin fənni, mövzuları öyrənmək marağını artırır, onlarda müxtəlif mənbələrdən informasiya toplamaq imkanı yaranır və təbiət hadisələrini əlaqələndirmək qabiliyyəti formalaşır. Tədris prosesində fənlərarası əlaqə yaratdıqda şagirdlərdə digər fənlərə qarşı da maraq artır və onların mövzu haqda anlayışları genişlənir.

Biologiya tədrisində elektron dərsliklərlə işin təşkili prinsipləri müxtəlif təhsil müəssisələri və müəlliflər tərəfindən müxtəlif olur. Ancaq, geniş şəkildə, elektron dərsliklərin təşkilatında və tədrisində aşağıdakı prinsiplər əsas rol oynayır:

8. **Interaktivlik:** Elektron dərsliklər interaktiv olmalıdır. Tədris materialının tərkibində video, təqdimatlar, animasiyalar, və interaktiv tapşırıqlar kimi müxtəlif multimedia elementlər yer almalıdır.



9. Əlaqəlilik: Dərslilər müxtəlif mövzular arasında quraşdırmaq üçün mümkün qədər əlaqəli və tətbiqi olmalıdır. Real həyat təcrübələri və günlük həyatla əlaqəli nümunələr tədris materialında geniş yer tutmalıdır.
10. Məşğulluq və Tətbiqatlar: Elektron dərslilər tədris materialını tətbiq etmək və məşğulluqları özündə əhatə etmək üçün tətbiqi və maraqlı məşğulluqlar təqdim etməlidir. Bioloji konseptləri laboratoriyaya tətbiqləri, sanal laboratoriyalar və ya animasiyalar vasitəsilə təqdim edilə bilər.
11. Təcrübəyə Əsaslanan Tədris: Təcrübəyə əsaslanan tədris metodu tətbiqi, tədqiqat, və müstəqil öyrənməni təşvik etməli və təmin etməlidir. Öyrəncilər müstəqil olaraq məlumatları almağa nail olmalıdırlar.
12. Adaptiv Tədris: Elektron dərslilər müxtəlif öyrənci bacarıqlarına və təcrübələrinə uyğun olmalıdır. Adaptiv tədris metodu, öyrəncilərə fərqli təlimatlar verərək hər birinin öz tempində öyrənməsinə imkan verir.
13. Rəqəmsal Təcrübə və Simulyasiyalar: Bioloji prosesləri və tədqiqatlar rəqəmsal təcrübə və simulyasiyalar vasitəsilə öyrəncilərə təqdim edilə bilər. Bu, öyrəncilərə abstrakt konseptləri daha yaxşı başa düşməkdə və məlumatları daha effektiv şəkildə öyrənməkdə kömək edir.
14. Müstəqil Öyrənmə İmkanları: Elektron dərslilər öyrəncilərə müstəqil öyrənmə imkanları təqdim etməlidir. Özü öyrənməyə və tədqiqat etməyə nail olmaq üçün özünü sınaşmaq və təşkil etmək üçün vəzifələr və tapşırıqlar olmalıdır.

Bu prinsiplər özünü tədris üçün ideal bir elektron dərslilik tətbiq etmək üçün istifadə edilə bilər və tədrisin effektivliyini artırır.

Biologiya müəllimi fənni ilə əlaqəli olan digər fənlərin elektron dərsliləri ilə tanış olur və həmin dərslikdə ona lazım olan məlumatların harada yerləşdiyini və ondan dərslin hansı hissəsində istifadə edəcəyini qabaqcadan müəyyənləşdirir. İnteqrasiyanın yaradılması təlimin keyfiyyətini yüksəldir və tədris prosesini fəallaşdırır. Biologiya tədrisini elektron dərsliliklərlə apardıqda verilən tələblərə əməl olunduqda təlimin keyfiyyəti yüksəlir. Şagirdlərin dəyişən mühitə uyğunlaşmasına, çətin problemlərin həllinə, sosial fəallığına, zəruri bacarıqların əldə edilməsinə şərait yaradır.

## ƏDƏBİYYAT

1. Azərbaycan Respublikasında təhsilin inkişafı üzrə Dövlət Strategiyası. (2013). 24 oktyabr. <https://president.az/articles/9779>



2. Azərbaycan Respublikasının ümumtəhsil məktəbləri üçün biologiya fənni üzrə təhsil proqramı. (kurikulumu) (vi-xi siniflər). Bakı: 2013, 75 s.
3. Biologiya-vəsait sorğu kitabçası. Bakı, 2010 Biologiya fənnindən VI-XI siniflər üzrə proqram materiallarının təxmini planlaşdırılması. «Təhsil problemləri» qəz. , Bakı: 2011, 08-15 sentyabr
4. Məmmədzadə, R. (2010). “Təhsildə keyfiyyət aparıcı istiqamətlərdən biri kimi”. Bakı: Müəllim.
5. Böyükağa Mikayılı Müasir dərslər: Yeni yanaşmalar. Gələcək uğurlara stimül . 2016 . 47-54 s Biologiya 7, 8, 9, 10, 11 sinif dərsləklər.
6. Budaqov B. Ə. Sovet Azərbaycanın təbiəti. Bakı: Maarif, 1988, Biologiya: Ümumtəhsil məktəblilərinin 7-ci sinif üçün dərslək / (Müəllif: U. M. Ələkbərov, V. B. İsmayılov, Ü. K. Ağamirov). Bakı: Xəzər nəşriyyatı, 2008, 128 s.
7. Mərdanov, M. (2003). “Təhsil sistemində monitoring və qiymətləndirmə”. Bakı: Çarşıoğlu.



## KÖYCEĞİZ İLÇESİNDE NÜFUSUN GELİŞİMİ POPULATION DEVELOPMENT IN KÖYCEĞİZ PROVINCE

Arş. Gör. Dr. Meryem KONCAK DOĞRUER

İstanbul Üniversitesi

ORCID: 0000-0002-6825-5486

### ÖZET

Köyceğiz, coğrafi olarak Türkiye'nin Güneybatı bölgesinde, Muğla iline bağlı bir ilçedir. İlçe, doğuda ve kuzeyde Muğla'nın Ortaca ve Dalaman ilçeleriyle, batıda Muğla'nın Marmaris ve Ula ilçeleriyle, güneyde ise Akdeniz'le çevrilidir. Köyceğiz'in tarihi, M.Ö. 2000 yıllarına kadar uzanmakta ve Likya uygarlığına dayanmaktadır. Bölge, antik çağlarda Kaunos şehri ile yakın ilişkiler içinde olup, tarım ve ticaretin yanı sıra, stratejik bir liman kenti olarak da önem taşımıştır. Arkeolojik kalıntılar, bölgenin Helenistik, Roma ve Bizans dönemlerinde de önemli bir yerleşim yeri olduğunu göstermektedir. Köyceğiz ilçesi 1927-2022 yılları arasında nüfus artışı ve ekonomik gelişme yaşamıştır. Köyceğiz; 1927'de 22.952 olan nüfusu, 1950'de düşüş göstererek 22.228'e gerilemiştir. Ancak sonrasında sürekli bir artış gözlenmektedir. 2022'de nüfusu 39.242'ye ulaşmış. Bu, özellikle 1970'lerden itibaren hızlanan bir artışı göstermektedir. Köyceğiz'e bağlı Terzialiler köyü 1943 yılında Ortaca adıyla resmîyet kazanmış, 1987'ye kadar Köyceğiz ilçesine bağlı bir belde iken 1987'de ilçe statüsü kazanmıştır. Köyceğiz ilçesine bağlı olan Atakent ve Dalaman beldelerinin birleşmesi ile 1983 yılında Dalaman ilçesi oluşturulmuştur. 1927-1940 yılları arasında Köyceğiz ilçesinin büyüme oranı % -24 'tür. 1927 yılı nüfus sayımına göre 22.952 olan Köyceğiz nüfusu 1935 yılında 16.287 ye gerilemiştir. Bunun temel sebebi; 1931ve 1934 tarihli Başbakanlık Kararnameleriyle Köyceğiz'e bağlı Karaman'ın Denizli Acıpayam ilçesine bağlanması ve bazı köylerinin merkez ilçeye bağlanmasıdır. 1935 yılı nüfus sayımına göre 16.287 olan toplam nüfus 1940 yılında 17.303'e yükselmiştir. Nüfus artış hızının son derece düşük olmasının sebebi o yıllarda devam eden ikinci Dünya Savaşı nedeniyle ülke ekonomisinin sarsılması ve bunun yol açtığı olumsuz ortamın olmasıdır. 1940-1960 yılları arasında Köyceğiz'de büyüme oranının %104 olarak artış gösterdiği anlaşılmaktadır. 1945 yılı nüfus sayımına göre 18.390 olan toplam nüfusu 1950 de 22.228'e yükselmiştir. II. Dünya savaşının bitmesi, tarımsal mekanizasyon sağlanması, 1950 yılında değişen iktidarın toprak reformuyla beraber köylülere toprak dağıtılması, tarımın desteklenmesi ve sanayi alanındaki gelişmeler bu artışın önemli nedenlerindedir. 1960-1980 yıllarında 35.810 kişiyle %101 oranında artış göstermiştir. Köyceğiz- Dalaman kesiminin pilot kalkınma bölgesi seçilmesi nüfusun artışında etkili olmuştur. Aynı zamanda 1967 yılında SEKA Kâğıt Fabrikasının kurulması iş gücü talebini arttırmış, bölgeye olan göçü arttırmıştır. 1980 yılında 71.144 olan nüfusu 1985 yılında 49.824, 2000 yılında ise 29.196 kişiye düşmüştür. 1980-2000 yıllarında %-58 oranında bir nüfus düşüşü yaşamasının sebebi; Ortaca ve Dalaman ilçelerinin Köyceğiz'den ayrılmasıdır. 2000-2022 yıllarında 10.046 kişi %34 oranında bir artış yaşanmıştır. Köyceğiz, 39,242 kişilik toplam nüfusuyla, kadın ve erkek nüfusunun hemen hemen eşit olduğu bir ilçedir. 19,442 kadın ve 19,800 erkek nüfusuyla, kilometrekare başına düşen nüfus yoğunluğu 32,46 kişidir. Bu durum, Köyceğiz'in geniş alanlara sahip ve nispeten düşük yoğunlukta bir yerleşim alanı olduğunu göstermektedir.

**Anahtar Kelimeler:** Köyceğiz, Nüfus, Nüfus Yapısı, Nüfus Değişimi



## ABSTRACT

Köyceğiz is geographically located in the southwestern region of Turkey, in the province of Muğla. The district is surrounded by Ortaca and Dalaman districts of Muğla to the east and north, Marmaris and Ula districts of Muğla to the west, and the Mediterranean Sea to the south. The history of Köyceğiz dates back to 2000 BC and is based on the Lycian civilization. The region was in close relations with the city of Kaunos in ancient times and was important as a strategic port city as well as agriculture and trade. Archaeological remains show that the region was also an important settlement during the Hellenistic, Roman and Byzantine periods. Köyceğiz district experienced population growth and economic development between 1927 and 2022. Köyceğiz's population, which was 22,952 in 1927, declined to 22,228 in 1950. However, a continuous increase is observed afterwards. In 2022, its population reached 39,242. This shows an accelerated increase, especially since the 1970s. Terzialiler village of Köyceğiz was officialized as Ortaca in 1943, and while it was a town of Köyceğiz district until 1987, it gained district status in 1987. Dalaman district was formed in 1983 with the merger of Atakent and Dalaman towns of Köyceğiz district. The growth rate of Köyceğiz district between 1927-1940 was -24%. According to the 1927 census, the population of Köyceğiz, which was 22.952, decreased to 16.287 in 1935. The main reason for this is that Karaman, which was connected to Köyceğiz, was connected to Denizli Acıpayam district and some of its villages were connected to the central district with the Prime Ministry Decrees dated 1931 and 1934. According to the 1935 census, the total population of 16.287 increased to 17.303 in 1940. The reason why the population growth rate was extremely low was that the country's economy was shaken due to the Second World War that was going on in those years and the unfavorable environment caused by this. It is understood that the growth rate in Köyceğiz increased by 104% between 1940 and 1960. According to the 1945 census, the total population of 18.390 increased to 22.228 in 1950. The end of World War II, the provision of agricultural mechanization, the distribution of land to the peasants with the land reform of the government that changed in 1950, the support of agriculture and the developments in the industrial field are among the important reasons for this increase. Between 1960 and 1980, the population increased by 101% with 35,810 people. The selection of Köyceğiz- Dalaman as a pilot development region has been effective in the increase in population. At the same time, the establishment of the SEKA Paper Factory in 1967 increased the demand for labor force and increased migration to the region. The population of 71.144 in 1980 decreased to 49.824 in 1985 and 29.196 in 2000. The reason for the -58% decrease in population between 1980-2000 is the separation of Ortaca and Dalaman districts from Köyceğiz. In the years 2000-2022, there was an increase of 10,046 people by 34%. With a total population of 39,242 people, Köyceğiz is a district where the male and female population is almost equal. With 19,442 women and 19,800 men, the population density per square kilometer is 32.46 people. This shows that Köyceğiz is a settlement area with large areas and relatively low density.

**Key Words:** Koycegiz, Population, Population Structure, Population Change





## ISI GERI KAZANIMLI HAVALANDIRMA

### HEAT RECOVERY VENTILATION

**Doç. Dr. Mustafa BUĞDAY**

Karabük Üniversitesi, Mekatronik, Mühendislik Fakültesi

Orcid Numara: 0000-0003-4413-509X

**Abakar IBRAHİM MAHAMAT**

Karabük Üniversitesi, Mekatronik, Mühendislik Fakültesi

Orcid Numara: 0009-0002-9741-0251

**Yacoub NAGI MOHAMED**

ÖĞRENCİ NUMARA:1810225542

Karabük Üniversitesi, Mekatronik, Mühendislik Fakültesi

Orcid Numara: 0009-0006-5177-5545

**Adam HISSEINE MAHAMAT**

Karabük Üniversitesi, Mekatronik, Mühendislik Fakültesi

Orcid Numara: 0009-0002- 5144-3373

## ÖZET

Isı geri kazanımlı havalandırma (HRV), iç ortam atmosferi tükendiğinde sıcaklığı geri kazanma ve dış ortamdaki gelen yeni atmosferi ısıtmak veya soğutmak için kullanma konsepti üzerine kurulu bir mekanizmadır.

Bu düzenleme bir ısı eşanjörü yardımıyla çalışır. İç ortam atmosferi tükendiğinde, ısı eşanjörü aracılığıyla bu atmosferden elde edilen sıcaklık, dışarıdan gelen yeni atmosferi ısıtmak veya soğutmak için kullanılır. Sonuç olarak, güç geri kazanılır ve ısıtma/soğutma için harcanan güç miktarı azalır.

Isı geri kazanım havalandırması, enerjiyi korumak, iç mekan hava kalitesini yükseltmek ve doğal etkiyi azaltmak için yapılarda veya mekanik ofislerde kullanılabilir. Bu çerçevede, iç mekan hava kalitesini yükseltirken enerji yeterliliği sağlayarak ekonomik bir düzenleme sunar.

**Anahtar Kelimeler:** Isı Geri Kazanımı, Havalandırma Sistemleri, Enerji Verimliliği, Sıcaklık Değişim Etkinliği, Hava Kalitesi, Havayı Temizleme ve Filtreleme, Hava Akışı ve Dolaşımı



## ABSTRACT

Heat recuperation ventilation (HRV) is a system grounded on the principle of recuperating the warmth from indoor air when it is exhausted and utilizing it to heat or cool new air approaching from outdoors.

This mechanism operates with the aid of a thermal exchanger. When the indoor atmosphere is depleted, the warmth acquired from this atmosphere via the thermal exchanger is utilized to warm or chill the new atmosphere arriving from the exterior. As a result, energy is regained and the quantity of energy consumed on warming/cooling is lessened.

Heat recovery ventilation (HRV) provides energy savings, improves indoor air quality, and reduces environmental impact when used in buildings or industrial facilities. This system offers a sustainable solution by enhancing indoor air quality while also ensuring energy efficiency.

**Keywords:** Heat Recover ,Ventilation Systems, Energy Efficiency, Temperature Exchange Efficiency, Air Quality, Air Cleaning and Filtration, Airflow and Circulation

## 1.Giriş

Isı geri kazanımlı havalandırma, bina içindeki havanın dışarıdaki temiz hava ile değiştirilirken, çıkış havasından elde edilen ısıyı geri kazanmayı amaçlayan bir sistemdir. Bu sayede enerji tasarrufu sağlanır ve bina içindeki hava kalitesi iyileştirilir. Çift akışlı ve tek akışlı olmak üzere iki temel türde bulunabilir. Çift akışlı sistemlerde giriş ve çıkış havaları ayrı kanallardan geçer, bu da daha etkili bir ısı transferi sağlar. Tek akışlı sistemlerde ise hava tek bir kanaldan geçer, bu nedenle çift akışlı sistemlere göre daha basit bir yapıları vardır.

Bu sistemler, bina sakinlerine sürekli temiz hava sağlayarak konforu artırır ve enerji maliyetlerini düşürmeye yardımcı olur. genellikle plakalı veya döner ısı eşanjörleri kullanarak çalışır. Bu eşanjörler, giriş ve çıkış havası arasında ısı transferini sağlar, böylece dışarıdaki havadan içerideki havaya geçen ısı kaybı veya kazancı minimize eder.

Bu sistemler, sıcak iklimlerde de etkili olabilir; çünkü sıcak giriş havası, çıkış havasından alınan ısı ile önceden ısınabilir, bu da soğuk mevsimlerde olduğu gibi enerji tasarrufu sağlar. Isı geri kazanımlı havalandırma, çevre dostu bir seçenek olup, bina enerji verimliliğini artırır.

partikül ve diğer kirleticilerin seviyelerini kontrol ederek sağlıklı bir iç hava kalitesi sağlamaya yardımcı olur. Ayrıca, bu sistemler genellikle akıllı bina yönetim sistemleriyle entegre edilebilir, bu da enerji kullanımını daha etkili bir şekilde optimize etmeye olanak tanır. Isı geri kazanımlı havalandırma, sürdürülebilir bina tasarımının bir parçası olarak çevresel etkiyi azaltmaya yönelik bir çaba sağlar.



### Mesh

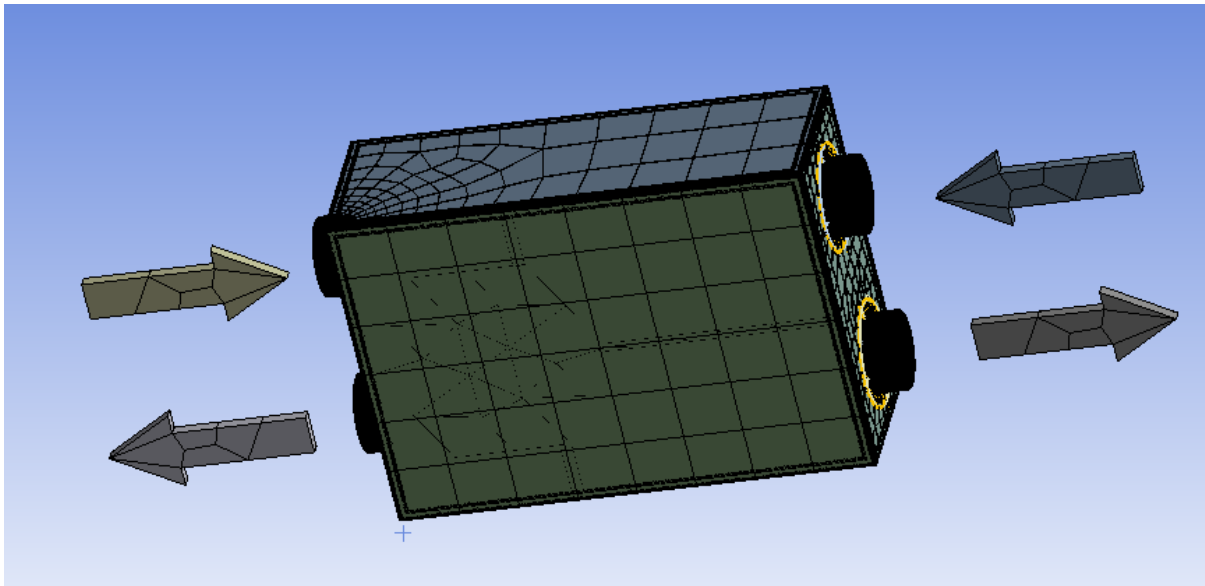

### Mesh durumu

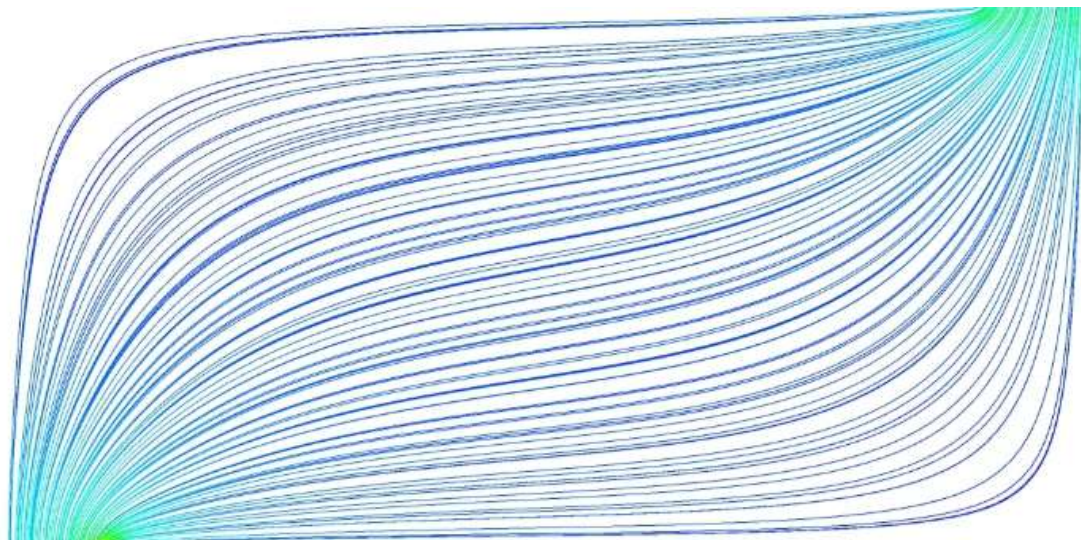
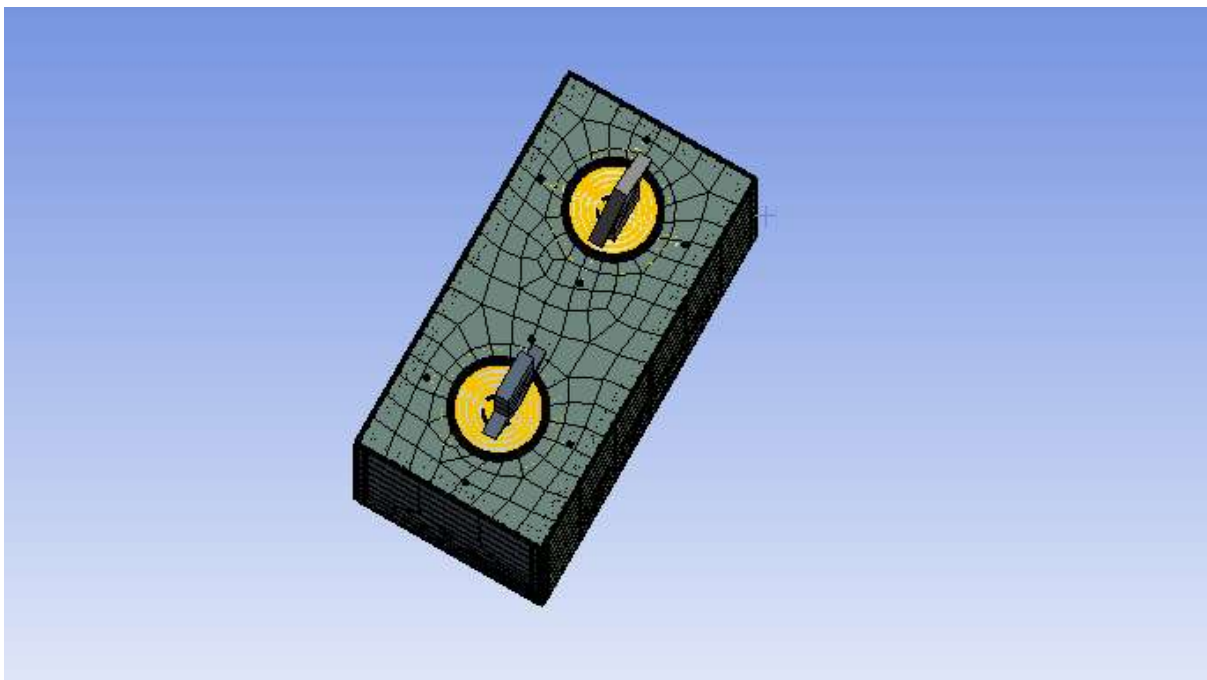



## Analizin grafik durumu

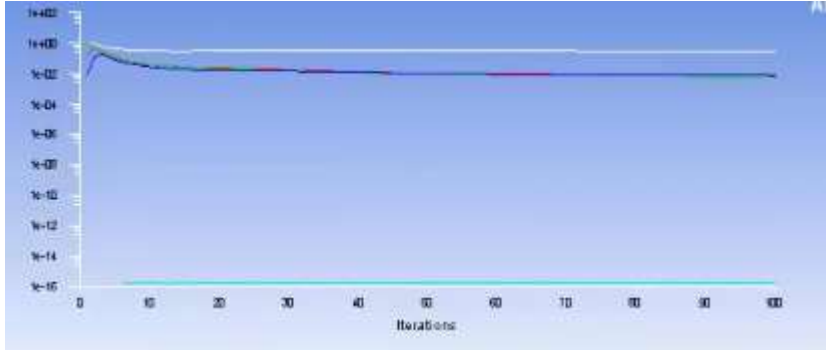

## Sonuç ve tartışma

Isı geri kazanımlı havalandırma sistemleri, enerji tasarrufu, iç hava kalitesinin iyileştirilmesi ve çevresel sürdürülebilirlik açısından önemli avantajlar sunar. Bu sistemler, binalarda kullanılan enerji miktarını azaltarak karbon ayak izini düşürebilir ve sürdürülebilir bir yaşam tarzını destekleyebilir. Ayrıca, iç hava kalitesini artırarak bina sakinlerinin sağlığını olumlu yönde etkiler.

Tartışmalar genellikle ısı geri kazanımlı havalandırma sistemlerinin maliyet etkinliği, kurulum zorlukları ve bakım gereksinimleri üzerine odaklanır. Bu sistemlerin ilk yatırım maliyeti yüksek olabilir, ancak uzun vadede enerji tasarrufu sağlayarak maliyetlerin karşılanmasına yardımcı olabilir. Kurulum ve bakım konuları da sistem performansını etkileyebilir, bu nedenle uzman tasarım ve düzenlemelerin önemi vurgulanmalıdır.

Sonuç olarak, ısı geri kazanımlı havalandırma sistemleri, enerji verimliliği, iç hava kalitesi ve çevresel sürdürülebilirlik açısından önemli avantajlar sunan, modern bina tasarımında etkili bir çözümdür. Ancak, bina sahipleri ve tasarımcıları, sistemleri doğru bir şekilde entegre etmek ve bakımını düzenli olarak yapmak için dikkatli bir planlama ve yönetim süreci uygulamalıdır.

## KAYNAKLAR/RESOURCES

<https://www.inspectmt.com/heat-recovery-ventilation-system/>

<https://www.pureventilation.com.au/heat-recovery/>

<https://www.paulheatrecovery.co.uk/>



**TARİHİ COĞRAFYAYA KATKILARI BAĞLAMINDA MAKDİSİ**  
**MAKDİSİ IN THE CONTEXT OF ITS CONTRIBUTION TO HISTORICAL**  
**GEOGRAPHY**

**Fatma ERASLAN**

Doktorant, Ahi Evran Üniversitesi

ORCID ID: 0009-0002-3661-8913

**Mustafa UYANIK**

Doktorant, Ahi Evran Üniversitesi

ORCID ID: 0009-0003-7757-4598

**ÖZET**

Var olduğu andan itibaren kültürü ve kültürel mirasını yaşadığı doğal-beşeri mekânda aramaya irdelemeye ve tasvir etmeye çalışan insanoğlu için ilk akla gelen disiplinler şüphesiz ki tarih ve coğrafya bilimleri olmuştur. Tarih sayesinde geçmişin izleri geleceğe ışık tutarken, coğrafya ile de geçmişten bağımsız mekânsal araştırmalar yapılabilmiş ve zamanla her iki bilimin senteziyle tarihi coğrafya kavramı ortaya çıkmıştır. Bu kavramın ortaya çıkmasıyla çeşitli coğrafi sahalarda geçmiş zaman dilimlerinde araştırılma imkânı elde etmiştir. Bu sayede birden fazla coğrafi sahanın durumu, zaman içerisindeki değişim ve gelişimi ortaya konurken, dün ve bugün arasındaki benzerlikler ile farklılıklar da daha kolay tespit edilebilmiştir.

Tarihi coğrafyaya yön vermesi ve katkı sağlaması bakımından Ahsenü't-Tekasim adlı coğrafi çalışmasını tarihi çerçevede ele almış olan Makdisi'nin önemi oldukça fazladır. Müellif, pek çok coğrafi sahaya yönelik ayrıntılı malumata eserinde yer vererek geçmişin coğrafyası olarak tanımlanan tarihi coğrafya çalışmalarına yepyeni bir bakış açısı kazandırmıştır. Ülkeleri coğrafi bölgeler esasına göre sınıflandırarak sınırları belirlenmiş ülke kavramını da ortaya koymuş olan Makdisi, şehirlere bağlı önemli yerleşim yerleri, şehirlerarası mesafeler, yollar yanında topografik ve jeolojik bazı bilgilere de eserinde yer vermiştir.

**Anahtar Kelimeler:** Tarih, Coğrafya, Makdisi, Tarihi Coğrafya



## ABSTRACT

The first disciplines that come to mind for human beings, who have been trying to search, analyze and describe their culture and cultural heritage in the natural-human space where they live since the moment they existed, have undoubtedly been the sciences of history and geography. While the traces of the past shed light on the future thanks to history, geography has been able to conduct spatial research independent of the past, and over time, the concept of historical geography emerged with the synthesis of both sciences. With the emergence of this concept, various geographical areas have had the opportunity to be researched in past time periods. In this way, while the situation of more than one geographical area, its change and development over time were revealed, the similarities and differences between the past and the present could be determined more easily.

In terms of guiding and contributing to historical geography, the importance of Maqdisi, who dealt with his geographical study *Ahsan al-Taqasim* within a historical framework, is quite high. By including detailed information on many geographical areas in his work, the author brought a brand new perspective to historical geography, which is defined as the geography of the past. Al-Maqdisi, who also introduced the concept of a country with defined borders by classifying countries on the basis of geographical regions, included important settlements connected to cities, distances between cities, roads, as well as some topographical and geological information in his work.

**Keywords:** History, Geography, Maqdisi, Historical Geography



## TETRAMERIASIS OF PHEASANTS IN SPRED BELGRADE AREA

Academician Dr. Ivan PAVLOVIC

Scientific Institute of Veterinary Medicine of Serbia, Belgrade, Serbia

ORCID ID: <https://orcid.org/0000-0003-4751-6760>

### ABSTRACT

Tetrameriasis is a parasitic infection of pheasants caused by roundworms. *Tetrameres fissispina*. *T. fissispina* are small worms, not longer than ~8 mm. They have a characteristic sexual dimorphism very seldom among helminths. Whereas the males are filiform, head and tail of the females are filiform too, but their body is globular, up to 5 mm in diameter and of a reddish color. As in other roundworms, the body of these worms is covered with a **cuticle**, which is flexible but rather tough. Each male has a bursa with two spicules for attaching to the female during copulation. *T. fissispina* have an indirect life cycle. Birds become infected through ingestion of an intermediate host, which are grasshoppers, cockroaches, earthworms, and water fleas. Adult female Tetrameres worms lay embryonated eggs in the host's gut that are passed in their droppings. Intermediate hosts ingest the eggs from the environment, which release the larvae a few hours later. These larvae complete development to infective L3 larvae in about 7 weeks and become encysted in the body of the intermediate host. The prepatent period (time between infection and first eggs shed) of Tetrameres worms is 7-8 weeks, depending on worm species and host. Adult female *T. fissispina* worms embed themselves into the glands or lining of the proventriculus, which induces nodules that can grow so large that they compress the glands and can cause them to atrophy. The mucosa of the proventriculus becomes irritated and inflamed from Tetrameres spp continuously feeding on blood. This can result in the accumulation of undigested food in the proventriculus, which can flow back to the esophagus and the crop that become obliterated. During research carried out in pheasantry in spread Belgrade area, infection with *Tetrameres fissispina*, was found at 1.04% of examined pheasants.

**Key Words:** *Tetrameres fissispina*, pheasants, Belgrade



**THE IMPACT OF MARKETING MIX ON THE IMPROVEMENT OF  
BANKING SERVICE QUALITY  
APPLIED STUDY ON ALAMMAN BANK, NALOOUT CITY- LIBYA**

**Mr. Ali Aleisawi NASR**

Faculty of Economic and Political Sciences, University of Naloot-Libya.

**ABSTRACT**

The study objective was to find out the impact of marketing mix on the improvement of bank services quality. The application of the study was on Alamman Bank in Naloot city – Libya. The study adopted the descriptive research method to describe the elements and the importance of marketing mix as well as identifying the elements of marketing and promotional mix. The collection of data and information has been done through distributing questionnaires which were directed to random sample from the targeted bank clients which were (352) entered the study. This was done to find out about their level of satisfaction on the services provided by the bank. The collected data was analyzed by using the statistical package for social sciences (SPSS). The study reached a number of results and recommendations, the most important result is: The marketing mix has an impact on the quality of bank services from the perspective of Alamman Bank clients. Referring to the study results, the study reached a number of recommendations. The most important is: The provision of advanced technology machines with continuous conservation to improve the bank services quality.

**Keywords:** Alamman Bank, service quality, marketing mix, promotional mix, bank clients





## أثر المزيج التسويقي في تحسين جودة الخدمة المصرفية دراسة تطبيقية على مصرف الامان – فرع نالوت - ليبيا

أ: علي العيساوي نصر  
قسم الإدارة، كلية الاقتصاد والعلوم السياسية، جامعة نالوت-ليبيا

### المستخلص

هدفت الدراسة إلى التعرف على أثر المزيج التسويقي في تحسين جودة الخدمة المصرفية. دراسة تطبيقية علي مصرف الامان فرع نالوت - ليبيا. واعتمدت هذه الدراسة على المنهج الوصفي لوصف أهمية وعناصر المزيج التسويقي وكذلك التعريف بجودة الخدمات المصرفية، وتحديد عناصر المزيج التسويقي والترويجي. وتم جمع البيانات والمعلومات من خلال استبانة تم توزيعها على عينة عشوائية قوامها (352) مفردة متمثلة في عملاء المصرف قيد الدراسة تم استخدامها في الدراسة للتعرف على مدى رضائهم وانطباعهم عن الخدمات التي يقدمها المصرف. وتم تحليل البيانات من خلال تطبيق الحزمة الاحصائية للعلوم الاجتماعية (SPSS). وتوصلت الدراسة الى عدد من النتائج أهمها: يؤثر المزيج التسويقي في جودة الخدمات المصرفية من وجهة نظر عملاء مصرف الأمان فرع نالوت. وبناء على نتائج الدراسة تم صياغة عدد من التوصيات من أهمها: توفير الأجهزة والتقنيات الحديثة وصيانتها باستمرار، كونها تساهم بشكل كبير في جودة الخدمات المصرفية.

**الكلمات المفتاحية:** مصرف الأمان، جودة الخدمات، المزيج التسويقي، المزيج الترويجي، عملاء المصرف.

### 1.1 مقدمة

شهد مجال تسويق الخدمات المصرفية تطورا ونمو ملحوظا في الآونة الأخيرة ، نظرا للتطورات المتسارعة في بيئة الاعمال المصرفية على وجه التحديد ؛ حيث تقضي طبيعة الأنشطة والاعمال المصرفية ضرورة العمل على ضمان استمرارية العلاقة بين العميل و المصرف ؛ اذ ان المؤسسات المصرفية أصبحت تتنافس على استقطاب العملاء بشتى الوسائل والحفاظ عليهم بتلبية متطلباتهم من الخدمات المصرفية التي يبحثون عنها وبالجودة المناسبة ويمثل المزيج التسويقي أداة هامة تؤدي من خلالها الانشطة التسويقية المختلفة ؛ حيث أن له علاقة بالأداء التسويقي للمنظمة ؛ ويتوقع أنه إذا حدث ضعف في أداء أي منها سيكون أثره السلبي مباشرة على الطرف الاخر (العملاء ) ؛ وان تقييم الزبائن لجودة الخدمات المصرفية لم يعد مرتبطا بمضمون الخدمة نفسها ؛ بل امتد الي الأسلوب الذي تؤدي به الخدمة من المزيج التسويقي الذي يصمم لهذا الغرض .وقد برزت في الآونة الأخيرة الحاجة الي تصميم ( محتوى ) مزيج تسويقي مناسب وإدخال التقنية الحديثة في المؤسسات المصرفية ؛ لتساهم في رفع جودة الخدمات المصرفية لتساهم في رفع جودة الخدمات المصرفية التي تقدمها ؛ والمزيج التسويقي قابل للتغير والتطوير ليواكب التغيرات المحيطة ويتكون المزيج التسويقي من أربعة عناصر رئيسية وهي : الخدمة ؛ السعر ؛ التوزيع ؛ الترويج ؛ واطافة للعناصر التقليدية الأربعة والتي تناولها الكثير من الكتاب والباحثين فقد اضيفة ثلاثة عناصر أخرى للمزيج التسويقي الخدمي لتتلاءم مع طبيعة الخدمات وخصائصها وهذه العناصر هي : عملية تقديم الخدمة ؛ الدليل المادي ؛ العنصر البشري ( الافراد العاملين ؛ العملاء ) .

### 2.1 مشكلة الدراسة

ومن أجل تحديد مشكلة الدراسة بشكل دقيق إلى جانب الاطلاع على الأبحاث والأدبيات ذات الصلة بالتسويق تم صياغة هذه المشكلة في التساؤل التالي : ( ما مدي تأثير المزيج التسويقي على جودة الخدمات المصرفية ؟ ) .



### 3.1 فرضيات الدراسة

#### ركز الباحث على اختبار الفرضين التاليين :

- أ- لا توجد علاقة ذات دلالة إحصائية بين تصميم المزيج التسويقي وجودة الخدمات المصرفية.
- ب- توجد علاقة ذات دلالة إحصائية بين تصميم المزيج التسويقي و جودة الخدمات المصرفية التي يقدمها المصرف قيد الدراسة .

#### 4.1 أهداف الدراسة : تسعى الدراسة إلي تحقيق جملة من الأهداف أهمها ما يلي :

- أ- محاولة تحديد مدى وجود تأثير المزيج التسويقي علي الخدمات المقدمة لعملاء المصرف قيد الدراسة.
- ب- التعرف على طبيعة الاتجاهات المتكونة لدى عملاء المصرف نحو مستوى جودة الخدمات المصرفية المقدمة من المصرف قيد الدراسة .

### 5.1 أهمية الدراسة

- أ- من الناحية النظرية :تتمثل أهمية هذا الدراسة في الإثراء الفكري للباحث من الناحية العملية والعلمية ؛وإثراء المكتبة العلمية بهذا النوع من البحوث.
- ب- من الناحية التطبيقية: تتمثل أهمية هذا الدراسة من الناحية التطبيقية في إبراز أثر المزيج التسويقي على جودة الخدمات المصرفية على عملاء المصرف قيد الدراسة من خلال توزيع صحيفة الاستبيان.

### 6.1 منهجية الدراسة

أعتمد الباحث في هذه الدراسة علي استخدام المنهج الوصفي والتحليلي، حيث ركز المنهج الوصفي على وصف الظاهرة محل الدراسة والمتمثلة في اثر المزيج التسويقي على جودة الخدمة المصرفية ، أما المنهج التحليلي أعتمد عليه في تحليل البيانات التي تم الحصول عليها من صحيفة الاستبيان وإيجاد العلاقة بين المتغيرات وتحليلها وتتمثل مصادر البيانات في التالي :

أ- مصادر ثانوية :ويتمثل في المسح المكتبي للأدبيات موضوع البحث من خلال الاطلاع علي المراجع والمصادر المتخصصة من الكتب والدوريات والمجلات والرسائل العملية سواء كانت منشورة أو غير منشورة، وكذلك المواقع الإلكترونية ذات العلاقة بالموضوع .

ب- المصادر الأولية :ويتمثل ذلك في البيانات الأولية التي سوف يتم الحصول عليها من خلال توزيع أسئلة الاستبانة على مفردات عينة الدراسة والتي يتم اختيارها وفقاً للأسس العملية الإحصائية.

#### 1.6.1 وسائل جمع البيانات

أعتمد الباحث عند جمع البيانات على تصميم وتوزيع استبانة على عملاء مصرف الامان فرع نالوت. وخضعت استمارة الاستبيان لمجموعة من الاختبارات للتأكد من مدى صدقها وثباتها وذلك من خلال اجراء الاختبارات الإحصائية اللازمة وباعتبار أن البيانات التي تم جمعها هي بيانات اسمية في معظمها فإنه يقترح استخدام مجموعة من الأساليب الإحصائية الملائمة لطبيعة تلك البيانات .

#### 2.6.1 مجتمع وعينة الدراسة



تكون مجتمع الدراسة من كافة عملاء مصرف الامان فرع نالوت، حيث بلغ (14000) عميل. وتم استهداف عينة عشوائية من مجتمع الدراسة بلغت (352) مفردة كما مبين بالجدول (1) ادناه بعد استبعاد الاستبيانات غير الصالحة للتحليل.

### 7.1 مفهوم المزيج التسويقي المصرفي

يشكل المزيج التسويقي مجموعات من العمليات المتجانسة لكل منها؛ والتي تهدف الي توفير الخدمة بما يحقق تعظيم ربحية المصرف بالتوازي مع تحقيق أعلى مستوى من رضا العملاء. ويتفق معظم المختصين على العناصر الأساسية للمزيج التسويقي التي تشمل : المنتج (الخدمة المصرفية) ؛ السعر؛ التوزيع؛ الترويج واضيف اخرون ثلاثة عناصر أخرى للمزيج التسويقي في مجال الخدمات وهي : العنصر البشرى والدليل المادي والعمليات ؛ حيث ينبغي أن ترتبط عناصر المزيج التسويقي المصرفي بشكل متوازن فيما بينها ؛ بحيث تعكس دور كل منها في تصميم السياسة التسويقية التي يجب ان تنسجم مع الواقع والبيئة التي يعمل بها المصرف . ويعرف المزيج التسويقي بوجه عام : بأنه " مجموعة من الأنشطة والوسائل التي يتخذها المصرف لإقناع العملاء بشراء منتج " (ابوتاية؛2008؛ ص52).

### 8.1 أهمية المزيج التسويقي المصرفي

تظهر أهمية المزيج التسويقي المصرفي في عدة معايير تسعى الي ربط الأهداف والاستراتيجيات والسياسات وجميع العناصر المكونة له ؛ وجعلها تعمل بشكل مترابط ومتفاعل ؛ كذلك في كونه الوسيلة الفعالة لتحقيق أهداف المصرف في تسويق خدماته الي العملاء الحاليين والمرتقبين بدرجة عالية من الكفاية والفاعلية (معلا؛1994؛ص22).

لذلك ينبغي علي المصارف وضع سياسة المزيج التسويقي بحذر شديد تجاه متغيرات السوق وعناصر المزيج التسويقي ؛ وذلك وفقا للظروف السائدة وبما ينسجم مع متغيرات واحتياجات السوق المصرفي ؛ بمعنى انه لا يوجد مزيج تسويقي مثالي يصلح لكل الظروف والحالات وبالتأكيد فإن عناصر المزيج المصرفي نفسها غالبا ما تتدخل مع بعضها البعض(نصير ؛2005؛ص30) .

### 9.1 عناصر المزيج التسويقي المصرفي

يمكن توضيح عناصر المزيج التسويقي المصرفي على النحو التالي :

**أولاً: الخدمة المصرفية :** وهي مجموعة من أنشطة وفعاليات الخدمة المصرفية التي يقدمها المصرف لغرض تلبية حاجات ورغبات الزبائن (الصميدعي ؛2005؛ص261) والحقيقة أن مفهوم التسويق الحديث ألقى بظلاله على المعاني التي تنطوي عليها الخدمة المصرفية بما اضى عليها قدرا من الشمولية ؛ ويمكن ان ينظر الي الخدمة المصرفية من زوايا ثلاثة هي (معلا؛1994؛ص49):

- جوهرية الخدمة المصرفية : ويمثل ذلك البعد الذي يرتبط مباشرة بالدافع الرئيسي الذي يقف وراء طلب الخدمة المصرفية ؛ أي مجموعة المنافع الأساسية التي يستهدف الزبون تحقيقها من وراء طلب الخدمة.
- الخدمة المصرفية الحقيقية : تشمل الخدمة وفقا لهذه الزاوية على اكثر من مجرد الجوهر؛ فهي تشير الي مجموعة الأبعاد الخاصة بالخدمة ؛ وهذا البعد في مضمون الخدمة المصرفية يرقى بجوهرها الي مستوى التفضيل لدى العملاء وتوقعاتهم .
- الخدمة المصرفية المدعمة ( المعززة ) : وهي تمثل مضموناً خدمياً متكاملًا وتشير الي جوهرية الخدمة وحقيقتها ؛ فضلا عن مجموعة من الخصائص والمزايا المقترنة بتقديمها وهي حل يسعى الزبون اليه وصولا للرضا والاشباع (العجارمة ؛ 2005؛ص135).



ثانياً: **السعر**: " يعبر السعر عن قيمة السلعة أو الخدمة ؛ سواء من وجهة نظر البائع أو من وجهة نظر المشتري " (الصيد 2007:ص58).

ويُعد التسعير من المشاكل الأساسية التي تواجه الإدارة في المنظمة الخدمية خاصة عند قيام المنظمة بتسيير خدماتها لأول مرة أو التغيير في الأسعار بسبب الظروف الاقتصادية أو ظروف المنافسة قوة الأثر النفسي للسعر في ذهن المستهلك ومن طرق تسعير الخدمات ما يلي (ابوتاية؛2008).

- التسعير على أساس التكلفة: وهي الطريقة السائدة في قطاع الخدمات وتعني إضافة نسبة موحدة على التكاليف الكلية .
- التسعير حسب الطلب: التسعير على أساس نوعية الطلب على الخدمة.
- التسعير التنافسي: وتعتمد هذه الطريقة على استراتيجية التسعير السائدة ؛ وتحاول المنظمة تحديد سعرها
- بحيث (نفس؛ أكثر؛ أقل) من أسعار المنافسين.

ثالثاً: **توزيع الخدمة** : تعرف بأنها "اتاحة السلع والخدمات للمستهلكين في المكان والزمان الملائمين" (مصطفى؛2003:ص158).

- قرارات تصميم القناة التوزيعية : يواجه مسوقو الخدمة مشاكل متعددة عند اتخاذ قرار خاص بتصميم القناة ؛ ولغرض الوصول إلي قرار سليم يتوجب أخذ ما يلي في الاعتبار (ابوتاية؛2008):
- تحليل الحاجات الخاصة بالزبون: حيث يتم تحديد الخدمات التي يمكن تقديمها في القطاعات السوقية والمراد الوصول إليها.
- تحديد القيد والاهداف الخاصة بالقناة : العناصر الواجب أخذها في الاعتبار عند تحديد الأهداف ؛ وهي خصائص الخدمة وسياسات المنظمة والوسطاء التسويقيين والعوامل البيئية المختلفة .
- مسؤوليات أعضاء القناة: حيث يتوجب على المنظمة تقييم كل بديل له علاقة بالاقتصاد والرقابة ومعايير التكيف في السوق .

**أنواع القنوات التوزيعية** : حيث يوجد نوعين أساسيين لقنوات توزيع الخدمة وهما :

- القناة المباشرة (القصيرة) : يمكن ان تكون هي الطريقة المناسبة لتوزيع الخدمات من خلال العناية باختيار الزبائن ؛ وكذلك مناسبة من حيث التلازم بين الخدمة ومقدمها ؛ ولكن في أغلب الأحيان يواجه مقدم الخدمة مشكلة وهي تمثل القناة المباشرة سوقا جغرافيا محددًا .
- القناة غير المباشرة ( الطويلة ): ويعتبر هذا النوع من القنوات الأكثر شيوعا في الاستخدام في المنظمات الخدمية ؛ويظهر اثر الوسطاء واضحا بشكل يمكن المنظمة من توزيع خدماتها إلي عدد كبير من الزبائن في مناطق جغرافية واسعة. ( يونس و محمد : 2002 :74)
- قنوات التوزيع الحديثة : تطور في السنوات الأخيرة قنوات توزيع الخدمة المصرفية بحيث شملت عدد من القنوات التوزيعية هي : (الخضري؛1999:199)



- الصراف الآلي (ATM): هذه الوسائل تتخذ لها أماكن معينة غالباً ما تكون في البناء المصرفي من الخارج بحيث يمكن للزبون استخدامها في أي وقت يشاء من اليوم الواحد وذلك عن طريق استخدام البطاقة المصرفية التي يتحصل عليها الزبون من المصرف .
- نظام تحويل الأموال إلكترونياً: أصبح توزيع الخدمات المصرفية أكثر فاعلية بتطوير نظام تحويل الأموال الإلكترونية حيث انتقل الأموال ما بين الزبائن وتجارة التجزئة والمصارف فعلى شكل بيانات إلكترونية .
- التسويق عن بعد: ازداد مستخدمي هذا الأسلوب بشكل كبير في الآونة الأخيرة ؛ وقد لوحظ نمو واضح في كل من القروض والودائع بواسطة التسويق عن بعد كما هو في حالة التسويق المباشر؛ استجابة للحملات الاعلانية بهذا الخصوص .

**رابعاً: ترويج الخدمة :** يعرّف ادوارد ووليم الترويج على إنه "التنسيق بين جهود البائع في إقامة منافذ المعلومات وفي تسهيل بيع السلع والخدمات أو في قبول فكرة معينة" (عبد الوهاب؛ 2006؛ 60)

ويعرف الترويج على أنه "عملية تعريف المستهلك بالمنتج وخصائصه ووظائفه ومزاياه وكيفية استخدامه وأماكن وجوده بالسوق وأسعاره بالإضافة إلى محاولة التأثير على المستهلك وحثه وإقناعه بشراء المنتج (أبو علفه 2002: 35) ."

### 10.1 عناصر المزيج الترويجي للخدمة (غنية 2000؛ 203)

- أ- البيع الشخصي : يتمثل البيع الشخصي في اتصال شخص من طرف رجال البيع بالمنظمة بالعملاء وإقناعهم بشراء السلع والخدمات .
- ب- تنشيط المبيعات : وهو تلك الجهود المبذولة من قبل رجال التسويق والتي من شأنها تعظيم حجم المبيعات ومن أمثلة هذه الجهود إقامة المعارض وتوزيع العينات العشوائية وغيرها .
- ج- النشر: يميز بعض الكتاب النشر كعنصر ترويجي عن الإعلان باعتبار أن المنظمة لا تدفع مقابل كما هو في الإعلان وهو وسيلة تتبناها المنظمة ولكن بطريقة غير مباشرة.
- د- الإعلان : عرف الإعلان على انه ((الوسيلة غير الشخصية لتقديم السلع والخدمات بواسطة جهة معلومة مقابل أجر معين (العسكري ؛ 2000؛ 198).
- هـ- تنشيط المبيعات : ويعني استخدام الوسائل المختلفة ذات التأثير الفعال والتي تسعى الي تسريع أو تقوية ردود الأفعال الإيجابية للعملاء (علي؛ 2000؛ 31) .
- و- الافراد (مقدمي الخدمة) : يعرف الافراد او مقدمو الخدمة بأنهم مجموعة من الافراد المشاركين في تقديم الخدمة للعميل ولهم تأثير على مدى تقبل الزبون للخدمة .
- ز- الدليل المادي : يعرف الدليل المادي على انه "البيئة المادية للمصرف المحيطة بالعاملين والعملاء اثناء انتاج وتسليم الخدمة مضافا اليها عناصر مادية ملموسة تستخدم للاتصال ودعم الخدمة .
- ح- عملية تقديم الخدمة: هي العنصر الأساسي لأي تقديم وتسليم الي الزبائن من خلال المزيج التسويقي وهي العمليات في كيفية تقديم وتوصيل الخدمة للزبائن؛ فالترحيب والاستقبال وحسن اهتمام الموظفين يساعد في التغلب على مشكلة انتظار الخدمة (شهبون؛ 2011؛ ص 38) .

### 11.1 جودة الخدمة المصرفية



أولاً: مفهوم جودة الخدمة المصرفية : تعرف جودة الخدمة المصرفية الإلكترونية بأنها ملاءمة ما يتوقعه العملاء من الخدمة المصرفية المقدمة إليهم مع إدراكهم الفعلي للمنفعة التي يحصل عليها العملاء نتيجة حصولهم على الخدمة، لذا فالخدمة الجيدة من وجهة نظر العملاء هي التي تتفق وتتطابق مع توقعاتهم. ( الباهي؛ 2016؛ 31).

ثانياً : أهمية جودة الخدمات المصرفية : حيث تتركز أهمية جودة الخدمات المصرفية في ثلاثة زوايا كالآتي :

- 1- جودة الخدمات كميزة تنافسية .
- 2- جودة الخدمات وتعزيز الميزة التنافسية .
- 3- الجانب السلبي لعدم تحسين الجودة .

ثالثاً : مستويات وابعاد الجودة الخدمات المصرفية : كما هو الحال في السلع فإن لجودة الخدمات المصرفية التي تقدم الي العملاء مستويات عدة منها (شهبون؛ 2011؛ 6)

- 1- الجودة التي يرى العملاء وجوب توفرها .
- 2- الجودة المدركة من إدارة المصرف والتي ترى أنها مناسبة لإرضاء العملاء .
- 3- الجودة القياسية وهي تلك الجودة التي تحدها إدارة المصرف بالموصفات النوعية الخدمية .
- 4- الجودة الفعلية هي الجودة التي تؤدي بها الخدمة فعلاً.
- 5- الجودة المروجة للعملاء وهي الجودة التي وعد بها العملاء من خلال الحملات الترويجية ويمكن قياس ملاحظة جودة الخدمة من خلال قياس الأداء ؛ وبالتالي فإن جودة الخدمة المصرفية لها مكونان أساسيان هما ( زهير، 1964؛ 77) :

- 1- الجودة الفنية (التقنية) وهي نتائج عمليات المصرفية .
  - 2- الجودة الوظيفية (المهنية) وهي البعد الاجرائي في شروط تفاعل العميل مع مقدم الخدمة .
- ولبيان ذلك فإن إدارة الوحدة المصرفية يفترض أن تتسأل مثلاً عن كل حالة من الحالات التي تتعايش معها يومياً ؛ فالعميل الذي يغادر المصرف هل انه تلقى الخدمة المطلوبة أم لا؛ وكم أمضي من الوقت ؟ وهل كان مقتنعاً فعلاً بكل ما جري ؟ وهل أدى الموظف واجبه تجاه الزبون في التعامل ؟ وغيرها من التساؤلات الأخرى .

#### رابعاً : الخدمات المصرفية :

وهي أي نشاط أو منفعة يستطيع المصرف تقديمها لطرف آخر لسد الحاجات التي تخلق الدوافع لسلوك المشتريين وموقفهم من الخدمة ومدى تجاوب الخدمة واستراتيجيات التسويق مع تلك الحاجات في أية مرحلة من مراحل حياة الخدمة المصرفية والتي تتطلب من الإدارة تبني استراتيجيات تسويقية تعزز من درجة ولاء الزبون لعلامة الخدمة وعدم السماح للمنافسين في التأثير على درجة الولاء المطلوبة (جودي ونغم؛ 2008؛ 45).

وأهم أنواع الخدمات المصرفية ما يأتي ( <https://sotor.com>):

- أ- القروض: تُعد البنوك مُنظمات تجارية تهدف إلى الربح لذا يُعد تقديم القروض أحد أهم الخدمات التي يتم تقديمها وذلك بهدف جني الفوائد من الأرباح، وتقوم البنوك على تقديم القروض قصيرة الأجل ومتوسطة الأجل وطويلة الأجل بعد الاحتفاظ بالاحتياطات النقدية.
- ب- الدفع بالشيك: تعمل البنوك على توفير شيكات لأصحاب الحسابات بحيث يُمكنهم من سحب شيك على البنك من أجل دفع المال، بحيث تقوم البنوك على الدفع للعملاء بعد التحقق من حساباتهم.
- ج- تحصيل ودفع أدوات الائتمان: تُقدم البنوك العديد من أدوات الائتمان المُختلفة، مثل: الكُمبيالة والسندات والشيكات، بحيث تقوم البنوك على جمع ودفع الأنواع المُختلفة من أدوات الائتمان على اعتبارها مُمثل للعملاء.
- د- صرف العُملة الأجنبية: تقوم البنوك على صرف العُملة الأجنبية بالعُملة المحلية من أجل تسوية المُستحقات في التجارة الدولية.
- هـ- الاستشارات: تعمل البنوك على توظيف خُبراء ماليين وقانونيين يعملون على تقديم المشورة للعملاء فيما يتعلق بالأمور التي ترتبط بالاستثمار والصناعة والتجارة والضرائب.

- و- تعمل بطاقات الائتمان على السماح لحاملها بإجراء عمليات شراء للسلع والخدمات، من خلال مُزود بطاقة الائتمان الذي يعمل على الدفع الفوري للسلع والخدمات، ليتعهد حامل البطاقة بتسديد مبلغ الشراء خلال فترة مُعينةٍ من الوقت.
- ز- خدمات أجهزة الصراف الآلي: تعمل أجهزة الصراف الآلي على تقديم العديد من الخدمات المصرفية كالإيداع والسحب والاستعلام عن الحساب.
- ح- خدمات بطاقات الخصم: وهي البطاقات التي تُمكن حاملها من سحب الأموال إلكترونياً من حساب حامل البطاقة.
- ط- الخدمات المصرفية عبر الإنترنت: وهي خدمة تعمل البنوك على تقديمها لأصحاب الحسابات بحيث تُمكنهم من الوصول إلى بيانات حساباتهم من خلال الإنترنت وتُتيح لهم بالقيام بالعديد من الخدمات، مثل: تحويلات الحساب، دفع الفواتير.
- ي- الاستعلام عن الرصيد: الخدمات المصرفية عبر الهاتف المتحرك: وهي تُتيح الوصول إلى الحساب ومعرفة المدفوعات والمُعاملات المصرفية الأخرى من خلال الهاتف المحمول.

#### خامساً: دورة حياة الخدمة المصرفية

دورة حياة الخدمة : تمر الخدمة من خلال دورة حياتها بعدة مراحل متتالية، والتي تختلف من مرحلة إلى أخرى حسب طبيعتها، وحسب نوعها، وتتمثل هذه المراحل: ( سونيا البكري ؛ 2000 : 11)



[www.uobabylon.edu.iq/eprints/pubdoc\\_x](http://www.uobabylon.edu.iq/eprints/pubdoc_x)

#### الشكل (1) يوضح دورة حياة الخدمة

- أ- مرحلة التقديم: تدخل في هذه المرحلة عملية تصميم و تنمية الخدمة، فتقدم الخدمة في هذه المرحلة للمرة الأولى أو بشكل مغاير لما كانت عليه و تمتاز هذه المرحلة بقلة إقبال المستهلكين على الخدمة الجديدة حيث تقدم على نطاق ضيق، و يمكن توسيعها إذا لقيت القبول من المستهلكين.
- ب- مرحلة النمو: تعتبر هذه المرحلة من أهم المراحل حيث تعكس سياسة واستراتيجيات المؤسسة، وتتميز هذه المرحلة بزيادة نمو الخدمة وارتفاع المبيعات مما يؤدي إلى زيادة الأرباح و يشجع دخول منافسين



- جدد، وكذلك مجهودات في تطوير الخدمة قصد البقاء في السوق، ويمكن خلال هذه المرحلة تحقيق نمو كبير للمبيعات والأرباح.
- ج- مرحلة النضوج: ما يميز هذه المرحلة هو انخفاض في المبيعات وتباطؤها، مع انخفاض عدد المستهلكين لتستقر عند نسبة معينة، ثم تبدأ بالانخفاض النسبي مجدداً مع الزمن، وهذا راجع للمنافسة الحادة و ظهور نفس الخدمات بأسعار أقل وبتقنيات متطورة، ويجب على المؤسسة التركيز على جودة الخدمة، واستعمال مختلف تقنيات التسويق حتى تحافظ المؤسسة على قدر من التنافسية.
- د- مرحلة التدهور: في هذه المرحلة ينخفض مستوى الخدمات المقدمة لجميع المؤسسات، وهذا راجع إلى ظهور خدمات جديدة .

### 12.1 خصائص الخدمات المصرفية

- 1- التعقيد : يرتبط التعقيد في العمليات المصرفية بطبيعة الخطوات وتسلسلها ؛ وعليه يمكن تقليل التعقيد من خلال دمج الأنشطة المتشابهة وإهمال الأنشطة غير الضرورية .
- 2- التنشت والاختلاف : يعزى التنشت في العمليات المصرفية إلى تباعد واختلاف الخطوات وتسلسلها ويمكن تطوير العمليات من خلال مخططات وتصاميم تقلل من خطواتها وتسلسلها وهذا يقضي الي تقليل التكاليف وتحسين الإنتاجية ويمكن من جعل جودة الخدمة أكثر تماثلاً واتساقاً.
- 3- كثافة العمل : تتميز العمليات المصرفية بكثافة عمل عالية إذ تتطلب تقديم الخدمات المصرفية للعملاء وفي الغالب يتم إجراءات معاملات متعددة ويمكن للمصارف الاستعانة بالتكنولوجيا لتوفير الوقت وخلق مزايا تنافسية في تقديم الخدمة مثل استخدام آلات السحب الذاتي ؛ وتحويل الأموال ومعرف الرصيد عن طريق الهاتف ؛ وغيرها من الخدمات التي تعتمد على شبكة المعلومات الدولية (الانترنت) حيث تسهم بشكل كبير في سرعة تقديم الخدمة للعميل .
- 4- الاعتماد الكبير على التكنولوجيا: تعتمد عملية تقديم الخدمة في مجال المصرفي على الاستخدام التكنولوجي بشكل كبير إذ يصعب إتمام اغلب المعاملات المصرفية دون وجود ميكنة حديثة كالحواسيب ؛ الات السحب الذاتي (جوده 2009; 80) .

### 13.1 الدراسة الميدانية

#### أولاً: منهجية الدراسة

- اعتمدت الدراسة على أسلوب المنهج الوصفي في دراسة طبيعة عناصر المسألة البحثية وأبعادها المختلفة، وهو بحث ميداني، لمعرفة أثر المزيج التسويقي في تحسين جودة الخدمة المصرفية بمصرف الأمان فرع/ نالوت وقد تم التركيز من خلال هذا المنهج على جانبين مكملين لبعضهما البعض وذلك على النحو الآتي: -
- 1- (الجانب التوثيقي المكتبي) مراجعة الكتب والأبحاث والدراسات المتوفرة وذات الصلة بموضوع الدراسة.
  - 2- (الجانب الميداني) الاعتماد على جمع البيانات ميدانياً بواسطة استبيان تم تصميمه لأغراض الدراسة.

#### ثانياً مجتمع وعينة الدراسة

تمثل مجتمع الدراسة في جميع عملاء مصرف الأمان فرع نالوت والبالغ عددهم (14000) عميل، وتم اختيار عينة حجمها (375) مفردة بطريقة العينة العشوائية، وذلك لصعوبة الوصول إلى جميع مفردات المجتمع، وتم تحديد حجم العينة بناءً على جدول ((Krejcie and Morgan (1970) لتحديد حجم العينة (سيكاران، 2007).

وقد تم توزيع عدد (380) استبانة لتفادي عدم استرجاع بعض الاستبيانات والجدول الآتي يبين ذلك: -





### جدول (1) إجراءات توزيع عينة الدراسة وحركة الاستبانة

الاستبانات الخاضعة للتحليل		الاستبانات الغير صالحة للتحليل	الاستبانات المفقودة	الاستبانات الموزعة
النسبة من الاستبانات	العدد			
92.6%	352	12	16	380

المصدر: الدراسة الميدانية

### ثالثا : أداة الدراسة

تم استخدام صحيفة الاستبانة لجمع البيانات والمعلومات من مجتمع الدراسة، واحتوت صحيفة الاستبانة على محور يقيس مدى مساهمة المزيج التسويقي في تحسين جودة الخدمة المصرفية واستخدام الباحث مقياس ليكرت الثلاثي للإجابة على عبارات محور الاستبانة وذلك لقياس درجة موافقة العينة على الفقرات المكونة لهذا الجزء من الاستبانة، وتتنحصر الإجابات وفق هذا المقياس في: [لا)، (نعم إلى حد ما)، (نعم)]، وتم تحديد أوزان الاستجابات للفقرات وفق الجدول (2) الآتي:

### جدول (2) أوزان الاستجابات حسب مقياس ليكرت الثلاثي للترتيب

الرأي	لا	نعم إلى حد ما	نعم
الدرجة	1	2	3

المصدر: الدراسة الميدانية

وتم تحديد اتجاهات أفراد العينة وفق مقياس ليكرت الثلاثي وفق الجدول (3)، حيث إن طول الفترة المستخدمة هي (2/3) أي حوالي (0.66) وقد حسبت طول الفترة على أساس أن أوزان الاستجابات الخمس (3-2-1)، وقد حصرت فيما بينها مسافتان والجدول (3) الآتي يبين ذلك.

### جدول (3) تحديد الاتجاهات وفق مقياس ليكرت الخماسي حسب المتوسط المرجح

تقييم المستوى	المتوسط المرجح	اتجاه الرأي
منخفض	من 1 إلى أقل من 1.67	لا
متوسط	من 1.67 إلى أقل من 2.34	نعم إلى حد ما
مرتفع	من 2.34 إلى أقل من 3	نعم

المصدر: الدراسة الميدانية

كما تم قياس ثبات أداة الدراسة (صحيفة الاستبانة) عن طريق احتساب (معامل كرونباخ ألفا ومعامل الصدق الذاتي) لجميع فقرات الاستبانة، وكانت معامل الثبات والصدق يتمتع بدلالات ثبات مقبولة لغايات البحث العلمي،



حيث وُجد أن قيمة معامل ألفا كرونباخ للمحور الصدق الذاتي مرتفعة، وبذلك يكون قد تأكد الباحث من صدق وثبات الاستبانة، وتكون الاستبانة في صورتها النهائية قابلة للتحليل، والنتيجة موضحة في الجدول رقم (4).

جدول رقم (4) يبين معاملات الثبات للاستبيان باستخدام طريقة ألفا كرونباخ

ت	البند	عدد الفقرات	معامل الثبات	معامل الصدق الذاتي
1	أثر المزيج التسويقي في تحسين جودة الخدمة المصرفية	21	0.770	0.877

مصدر: الدراسة الميدانية

رابعاً: وصف متغير الدراسة:

وصف متغيرات الدراسة

1-التحليل الوصفي: هل يؤثر المزيج التسويقي في تحسين جودة الخدمات المصرفية، من وجهة نظر مفردات عينة الدراسة(العملاء)، تم استخدام المتوسط الحسابي والانحراف المعياري والجدول الاتي يبين ذلك:

الجدول رقم (5) يبين المتوسط الحسابي والانحراف المعياري لعبارات المحور

ت	العبارات	المتوسط الحسابي	الانحراف المعياري	مستوى الموافقة
1	يوفر المصرف أجهزة حديثة وتكنولوجيا لتقديم خدمات للعملاء.	2.64	.6210	مرتفع
2	تتميز الخدمات المقدمة في المصرف بأنها متنوعة وذات مواصفات عالية تلبي رغبات جميع العملاء.	2.75	.5180	مرتفع
3	تخلو المعاملات أثناء تقديم الخدمة من المصرف من الشك والمخاطرة.	2.75	.5180	مرتفع
4	يتناسب سعر الخدمة المصرفية التي يقدمها المصرف للعملاء مع مستوى الجودة التي يبحث عنها في تلك الخدمة.	2.43	.7420	مرتفع
5	تتيح ساعات العمل الرسمية بالمصرف حصول العملاء على الخدمات المصرفية في الوقت المناسب.	2.50	.6940	مرتفع
6	يسهم العاملون بالمصرف دائماً في حل المشكلات التي قد تواجه العملاء في طلبهم للخدمة في الزمان والمكان المناسبين.	2.36	.5590	مرتفع
7	توجد لوحات ارشادية وملصقات توضح للعملاء خطوات وإجراءات طلب الخدمة المصرفية والحصول عليها بسهولة	2.14	.8480	متوسط



			ويسر.	
منخفض	.3780	1.07	يقدم المصرف بعض الخدمات المجانية والهدايا التذكارية كوسيلة ترويجية مهمة في التعريف بخدمات المصرفية المختلفة لدى العملاء.	8
مرتفع	.7930	2.50	ينفذ المصرف حملات إعلانية للتعريف بخدمات المصرفية المقدمة لجمهور العملاء عبر وسائل الإعلان المختلفة.	9
منخفض	.7310	1.64	تتوفر أماكن لانتظار العملاء داخل المصرف من خلال صالات وموثثة ومكيفة ومريحة مع وجود دورات مياه.	10
مرتفع	.5670	2.39	يتميز مبني المصرف بمظهر عصري وجذاب من الداخل والخارج.	11
مرتفع	.6340	2.57	تتوفر لدى المصرف التقنيات كالصراف الآلي المستخدمة لخدمة العملاء.	12
متوسط	.4480	1.86	يأخذ المصرف بعين الاعتبار الآراء والمقترحات المقدمة من العملاء لأجل تطوير الخدمات المصرفية.	13
مرتفع	.4160	2.89	يقدم المصرف كشوفات حساب واضحة ودقيقة خالية من الأخطاء وبسريرة تامة.	14
مرتفع	.5350	2.71	تتميز الخدمة المصرفية التي يقدمها المصرف بالجودة المطلوبة مقارنة بالمصارف الأخرى.	15
مرتفع	.5180	2.75	يقدم المصرف خدمة اصدار البطاقات الالكترونية الدولية بشكل سريع ودون عراقيل.	16
مرتفع	.3560	2.86	يحافظ المصرف على سرية البيانات والمعلومات الخاصة بعملاء المصرف مما يشعرهم بالثقة والأمان.	17
مرتفع	.5590	2.64	يقوم مقدم الخدمة بالمعاملة الودية مع الزبائن لكسب احترامهم.	18
مرتفع	.5090	2.50	تتصف الخدمات المقدمة من المصرف بأنها موضوعية تسعى لتحقيق اهداف جودة الخدمة	19
مرتفع	.6900	2.57	تبذل جهود واضحة من المصرف لتلبية احتياجات الزبون ومواءمة الخدمة بشكل مناسب.	20
مرتفع	.6290	2.61	هناك تحسن ملحوظا في جودة الخدمات المصرفية المقدمة للعملاء في ظل المزيج التسويقي الذي يقدمه العملاء.	21



مرتفع	0.253	2.44	المتوسط الحسابي الكلي للمحور
-------	-------	------	------------------------------

المصدر: الدراسة الميدانية

تبين من الجدول السابق أن المعدل العام لعبارات المحور جاءت بمتوسط حسابي بلغ (2.44) أكبر من المتوسط الافتراضي أي مرتفع، وكانت آراء أفراد العينة للعبارة رقم (14) (يقدم المصرف كشوفات حساب واضحة ودقيقة خالية من الأخطاء وبسرية تامة)، والتي جاءت في الترتيب الأول بمتوسط حسابي بلغ (2.89) وتعتبر عن درجة الموافقة بمستوى مرتفع أي أن أفراد العينة يرون أن المصرف يقدم كشوفات حساب واضحة ودقيقة خالية من الأخطاء وبسرية تامة، أما العبارة رقم (17) جاءت في الترتيب الثاني (يحافظ المصرف على سرية البيانات والمعلومات الخاصة بعملاء المصرف مما يشعرهم بالثقة والأمان) بمتوسط حسابي بلغ (2.86) بمستوى مرتفع أي أن عملاء المصرف يرون أن المصرف يحافظ على سرية البيانات والمعلومات الخاصة بعملاء المصرف مما يشعرهم بالثقة والأمان.

أما باقي العبارات (7- 13) فجاءت بأوساط حسابية متوسطة أقل من الوسط الافتراضي بمستوى متوسط أي أنه توجد لوحات إرشادية وملصقات توضح للعملاء خطوات وإجراءات طلب الخدمة المصرفية والحصول عليها بسهولة ويسر وأن المصرف يأخذ بعين الاعتبار الآراء والمقترحات المقدمة من العملاء لأجل تطوير الخدمات المصرفية نوعاً ما.

أما العبارة رقم (8) جاءت في الترتيب الأخير (يقدم المصرف بعض الخدمات المجانية والهدايا التذكارية كوسيلة ترويجية مهمة في التعريف بخدمات المصرفية المختلفة لدى العملاء) جاءت بمتوسط حسابي (1.07) ويلبها العبارة رقم (10) التي تنص على (تتوفر أماكن لانتظار العملاء داخل المصرف من خلال صالات ومؤثثة ومكيفة ومريحة مع وجود دورات مياه) بمستويات موافقة منخفضة، ونلاحظ من خلال الأرقام المعبرة عن الانحرافات المعيارية أنها منخفضة ويدل على وجود اختلاف قليل في آراء الزبائن لهذه العبارات. ويدل هذا التقييم على وجود أثر للمزيج التسويقي في تحسين جودة الخدمات المصرفية وبمستوى موافقة مرتفعة حسب المقياس المعتمد في الدراسة، وبذلك يكون قد تحقق هدف من أهداف الدراسة.

#### خامساً: اختبار الفرضيات والنتائج والتوصيات

##### أولاً: اختبار فرضيات الدراسة

في اختبار فرضيات الدراسة تم تحديد القواعد التي تم إتباعها والمتمثلة في الآتي:  
مستوى المعنوية (دلالة) لهذه الدراسة يساوي (0.05) ودرجة الثقة المتبعة في هذه الدراسة 95%، وتم الاختبار من خلال المقارنة بين مستوى المعنوية لهذه الدراسة والذي يساوي (0.05) وقيمة مستوى المعنوية المشاهد، وبناء على ذلك تم رفض الفرضية الصفرية وقبول الفرضية البديلة في حالة أن كانت قيمة مستوى المعنوية المشاهد أقل من أو مستوى المعنوية لهذه الدراسة (0.05) والعكس صحيح.  
الفرضية الرئيسية الأولى: (يؤثر المزيج التسويقي في تحسين جودة الخدمات المصرفية، بمصرف الأمان- نالوت.

ولإجراء الاختبار يستلزم إعادة صياغتها في صورة فرضية إحصائية، بحيث تكون على النحو الآتي:



$H_0$ : لا يؤثر المزيج التسويقي في تحسين جودة الخدمات المصرفية

$H_1$ : يؤثر المزيج التسويقي في تحسين جودة الخدمات المصرفية

ولاختبار الفرضية، استخدم الباحث اختبار  $T$  للعينة الواحدة ( One Sample T-Test ) وذلك للتحقق من صحة هذه الفرضية، ومعرفة معنوية (دلالة) آراء أفراد عينة الدراسة في هذه الفرضية، والجدول التالي يبين المتوسط الحسابي المرجح للفرضية والانحراف المعياري لها، وكذلك نتائج اختبار  $T$  (قيمة الاختبار والدلالة الإحصائية).

جدول رقم (6) المتوسط الحسابي المرجح والانحراف المعياري ونتائج اختبار  $T$

النتيجة	الدلالة الإحصائية	إحصاءه اختبار $T$	الانحراف المعياري	المتوسط المرجح
نرفض $H_0$	0.002	-3.445	0.253	2.44
* دالة إحصائية عند مستوى المعنوية 0.05				

المصدر: الدراسة الميدانية

نلاحظ من خلال بيانات الجدول رقم (6) أن المتوسط الحسابي المرجح يساوي (2.4) وانحراف معياري (0.253) مناظر له وان قيمة إحصاء الاختبار (-3.445) بدلالة إحصائية (0.002) وبما أن هذه القيمة أقل من مستوى المعنوية المعتمد (0.05) مما يشير إلى رفض الفرضية الصفرية  $H_0$  وقبول الفرضية البديلة  $H_1$ ، التي نصها " يؤثر المزيج التسويقي في تحسين جودة الخدمات المصرفية، بمستوى مرتفع كون قيمة المتوسط الحسابي المرجح أكبر من المتوسط المعتمد في الدراسة.

سادسا: النتائج والتوصيات

### 1- النتائج

تم التوصل إلى مجموعة من النتائج الآتية: -

1. يؤثر المزيج التسويقي في جودة الخدمات المصرفية من وجهة نظر عملاء مصرف الأمان فرع نالوت.
2. يوفر المصرف أجهزة حديثة وتكنولوجيا لتقديم خدمات للعملاء متنوعة وذات مواصفات عالية تلبية رغبات جميع العملاء.
3. يقدم المصرف كشوفات حساب واضحة ودقيقة وتخلو معاملات المصرف من الشك والمخاطرة.
4. يقدم خدمة اصدار البطاقات الالكترونية الدولية بشكل سريع ودون عراقيل.
5. تتميز الخدمة المصرفية التي يقدمها المصرف بالجودة المطلوبة مقارنة بالمصارف الأخرى.

### 2- التوصيات:

في ضوء نتائج الدراسة يمكن تقديم مجموعة من التوصيات: -

1. زيادة الاهتمام بالمزيج التسويقي كونه يؤثر بشكل كبير في جودة الخدمات المصرفية من وجهة نظر عملاء مصرف الأمان فرع نالوت.



2. توفير الأجهزة والتقنيات الحديثة وصيانتها باستمرار، كونها تساهم بشكل كبير في جودة الخدمات المصرفية.
3. على المصرف الاهتمام بالترويج كتقديم الخدمات المجانية والهدايا التذكارية للتعريف بخدمات المصرفية المختلفة لدى العملاء
4. على المصرف الاهتمام بتوفير أماكن لانتظار العملاء داخل المصرف من خلال صالات مجهزة ومكيفة ومريحة مع توفر دورات مياه.
5. زيادة الاهتمام باللوحات الإرشادية والكتيبات التي توضح للعملاء خطوات وإجراءات طلب الخدمة المصرفية والحصول عليها بسهولة ويسر.

#### 14.1 المصادر:

##### أولاً: الكتب

- المهدي غنية ، التسويق الأسس المفاهيم والمبادئ (دار الكتب الوطنية،بنغازي ط1، 2000 )
- تيسير العجارمة ؛ التسويق المصرفي ؛ عمان : دار الحامد للنشر والتوزيع 2005
- صباح محمد ابوتاية؛ التسويق المصرفي بين النظرية والتطبيق؛ ( عمان : دار وائل للنشر؛2008م )
- -ناجي معلا ؛ أصول التسويق المصرفي (عمان : معهد الدراسات المصرفية ؛ 1994م )
- محمد طاهر نصير؛ التسويق الإلكتروني ( عمان : دار الحامد للنشر والتوزيع ؛ 2005 م )
- محمود جاسم الصميدعي ؛ ردينه عثمان يوسف ؛ التسويق المصرفي ؛ مدخل استراتيجي كمي تحليل ( عمان : دار المناهج والتوزيع ؛2005م).
- محمد مصطفى ؛ التسويق الاستراتيجي للخدمات(عمان: دار المناهج 2003م )
- نجلة يونس ؛ وزيرة محمد ؛ قنوات تسويق الخدمة ( مجلة تنمية الرافدين ؛ كلية الإدارة؛ جامعة الموصل ؛ المجلد 24؛ العدد69 2002
- محسن أحمد الخضري ؛ التسويق المصرفي ؛( القاهرة : ايتراك للنشر والتوزيع ؛1999 م )
- عصام الدين ابو علفه، الترويج والنظرية والتطبيق ، مؤسسة طيبة ، القاهرة 2002
- - عبد الستار محمد على ؛ إدارة الإنتاج والعمليات مدخل كمي (عمان دار وائل للنشر والتوزيع ؛ 2000م )
- مصطفى زهير ؛ بحوث التسويق ؛ ( القاهرة : مكتبة عين الشمس ؛1964)
- حيدر حمزة جودي ونغم علي الصانع، أثر استراتيجيات استهداف السوق في الخدمة المصرفية، مجلة الإدارة والاقتصاد، العدد 69/2008،
- سونيا محمد البكري، إدارة الجودة الكلية، الدار الجامعية، 2002 .

##### ثانياً: رسائل الماجستير .

- صلاح الدين مفتاح سعد الباهي، أثر جودة الخدمات المصرفية الالكترونية على رضا الزبائن، رسالة مقدمة متطلبات الحصول على شهادة الماجستير في إدارة الاعمال، قسم إدارة الاعمال كلية إدارة الأعمال، (جامعة الشرق الاوسط، الاردن، 2016.
- جباري عبد الوهاب، أثر دراسة السلوكيات الشرائية للمستهلكين على فعالية السياسة الترويجية للمؤسسة، رسالة ماجستير غير منشورة( جامعة محمد بوضياف ، المسلية ، 2006).
- عبد الباسط علي شهبون ؛ ؛المزيج التسويقي واثره في جودة الخدمات المصرفية دراسة تطبيقية على قطاع المصارف التجارية بمنطقة زوارة رسالة ماجستير غير منشورة ؛(الاكاديمية الليبية ؛ 2011م )



ATLAS 11. INTERNATIONAL  
CONGRESS ON ADVANCED SCIENTIFIC STUDIES AND INTERDISCIPLINARY RESEARCH

---

- خالد علي خليفة جبودة ؛ المزيج التسويقي الخدمي وأثره على رضا العملاء ؛ دراسة ميدانية لجمهور العملاء المستفيدين من الخدمات المصرفية المقدمة من بعض فروع مصرف الجمهورية بمنطقة الجبل الغربي رسالة غير منشورة ؛ اكايمية الدراسات العليا ؛ طرابلس ليبيا ؛ 2009

ثالثًا: المواقع الالكترونية

- [https://www.uobabylon.edu.iq/eprints/pubdoc\\_6\\_10113\\_6071.docx](https://www.uobabylon.edu.iq/eprints/pubdoc_6_10113_6071.docx)  
الدخول يوم الاحد 5-11-2023 ؛ الساعة 9:00
- <http://www.sotor.com>
- الدخول يوم الثلاثاء 7-11-2023 ؛ الساعة 10:30



**OSMANLI VAKIFLARI VE SOSYAL İŞLEVSELLİĞİ: BURSA İL ÖRNEĞİ**  
**OTTOMAN FOUNDATIONS AND THEIR SOCIAL FUNCTIONALITY: THE CASE OF**  
**BURSA PROVINCE**

**Tuğba ÖNEY**

Bursa Teknik Üniversitesi

ORCID NO: 0000-0003-1835-9671

**ÖZET**

Bu araştırmamız, Osmanlı İmparatorluğu'ndaki kuruluşlar ve toplumsal rolü çerçevesinde yürütülmüştür. Osmanlı Devleti'nin kurucusu ve ilk hükümdarı Osman Bey'in oğlu Orhan Bey tarafından 06 Nisan 1326 günü fethedilen Bursa, 1365 yılına kadar Osmanlı Devleti'nin başkenti olmuştur. Osmanlı döneminde Bursa'da kurulan kuruluşlar, kurucuları, bağışları, mali kaynakları, harcamaları, hizmet alanları, bağış faaliyetleri, görevlileri ve Bursa'nın kent yaşamına katkıları dahil olmak üzere ayrıntılı bilgi verilmektedir. Vakıflar, sosyal işbirliğinin geliştirilmesine, gelir dağılımının ve sosyal bağların düzenlenmesine ve sanayi sektöründeki işgücünün genişlemesine katkıda buldukları için sosyal yaşamda önemli bir rol oynamaktadır. Bu kuruluşlar eğitim, sağlık, din, şehir planlama ve imar hizmetleri gibi çeşitli alanlarda araştırmaların uygulanmasını kolaylaştırarak şehirleri sosyal ve ticari alanda hareketlendirir. Bursa'ya özgü sınırlı sayıda yerel tarih çalışması vardır ve bunlar belirli zaman dilimlerine göre sınıflandırılmıştır. Bu çalışma Bursa araştırmalarında bahsedilen keşfedilmemiş yönler ışık tutmayı ve vakıfların incelenmesi yoluyla kentin tarihine, sosyo-ekonomik kültürüne farklı bir açıdan bakmayı amaç edinmiştir. Araştırma, öncelikle ilgili literatürü derinlemesine gözden geçirerek Osmanlı döneminde Bursa vakıflarının sosyal işlevlerini araştırmaktadır. Bu çalışmada, belirli zaman dilimlerinde Bursa'da kurulan vakıfların kapsamlı bir derlemesi sunulmaktadır. Bu vakıf kurumlarının çoğunluğu, temel yapıların bakım ve onarımı için fon sağlayan, bu kuruluşlarda çalışanlara ücretlerini tahsis eden, mahallelerde ve köylerde çeşitli kamu projelerinin başarılı bir şekilde yürütülmesini sağlayan Avariz Vakfı kapsamındadır. Sonuç olarak, belirli zaman dilimlerinde Bursa'da kurulan vakıfların Avariz Vakfı ile ilişkilerini gösteren kapsamlı bir envanteri sunulmuştur. Avariz Vakfı'nı sermaye açısından inceledikten sonra, faaliyetlerinin önemli bir kısmının para sistemi aracılığıyla işlediği anlaşılmaktadır. Ayrıca, ilk değerlendirme vakfın yasal çerçevesini, organizasyonel prosedürleri, hedefleri, yönetimi ve denetim sistemini de dikkate alınmıştır. Bu araştırmanın yürütüldüğü zaman çerçevesi Osmanlı döneminin 258 yılını kapsamaktadır ve bu nedenle Bursa Vakfı'nın kalıcı doğasını aydınlatan kapsamlı bir araştırmadır. Bu çalışmanın bulguları, Bursa'daki vakıfların yüzde 24'ünün 100 yılı aşan faydalı bir ömre sahip olduğunu göstermektedir.

**Anahtar kelimeler:** Osmanlı, Vakıf, Sosyal işlev, Bursa.





## ABSTRACT

This research was conducted within the framework of organizations and their social roles in the Ottoman Empire. Bursa, which was conquered by Orhan Bey, the son of Osman Bey, the founder and first ruler of the Ottoman Empire, on April 6, 1326, became the capital of the Ottoman Empire until 1365. Detailed information is given about the organizations established in Bursa during the Ottoman period, including their founders, donations, financial resources, expenditures, service areas, donation activities, officers and their contributions to Bursa's urban life. Foundations play an important role in social life, as they contribute to the development of social cooperation, the regulation of income distribution and social ties, and the expansion of the workforce in the industrial sector. These organizations stimulate cities socially and commercially by facilitating the implementation of research in various fields such as education, health, religion, urban planning and development services. There are a limited number of local history studies specific to Bursa and they are classified according to certain time periods. This study aims to shed light on the unexplored aspects mentioned in Bursa research and to look at the history and socio-economic culture of the city from a different perspective through the examination of foundations. The research first investigates the social functions of Bursa foundations in the Ottoman period by thoroughly reviewing the relevant literature. In this study, a comprehensive compilation of the foundations established in Bursa in certain periods of time is presented. The majority of these foundation institutions are within the scope of the Avariz Foundation, which provides funds for the maintenance and repair of basic structures, allocates salaries to employees of these institutions, and ensures the successful execution of various public projects in neighborhoods and villages. As a result, a comprehensive inventory of the foundations established in Bursa in certain periods of time is presented, showing their relationship with the Avariz Foundation. After examining the Avariz Foundation in terms of capital, it becomes clear that a significant part of its activities operate through the monetary system. Additionally, the initial assessment took into account the foundation's legal framework, organizational procedures, objectives, management and audit system. The time frame in which this research was conducted covers 258 years of the Ottoman period and is therefore a comprehensive study that illuminates the enduring nature of the Bursa Foundation. The findings of this study show that 24 percent of the foundations in Bursa have a useful life of more than 100 years.

**Keywords:** Ottoman, Foundation, Social function, Bursa.



## GİRİŞ

Osmanlı Vakıfları ve Sosyal İşlevselliği: Bursa İl Örneği başlıklı araştırma, 1326 yılında Osmanlı Devleti'nin kurucusu ve ilk sultanı Osman Bey'in oğlu Orhan Bey'in Edirne'nin fethedilmesine ve 1365 yılında yeni başkent haline gelene kadar Osmanlıların başkenti olarak hizmet veren Bursa'da Osmanlı döneminde vakıflar ve sosyal işlevleri üzerine odaklanmaktadır. Çalışmada, Bursa'da kurulan vakıflar, kurucuları, finansal yönleri, hizmet alanları ve kentin sosyal dokusuna katkıları hakkında kapsamlı bilgiler verilmektedir. Bu çalışmanın temel amacı, mevcut literatürden içgörüler çıkararak Bursa vakıflarının Osmanlı döneminde toplumsal işlevlerini tanımlamak ve değerlendirmektir. Bu kapsayıcı amaç dâhilinde, Osmanlı döneminde Bursa'da kurulan tüm vakıfların tanımlanması, kurumsal yapılarının, faaliyetlerinin, finansmanlarının ve cami, medrese, okul, kütüphane, mutfak ve bu vakıfların desteklediği diğer tesisler gibi çeşitli kurumlar incelenmiştir. Araştırma ayrıca dinlenme evleri, pansiyonlar, hamamlar, kapalı pazarlar gibi vakıf çalışmalarının ve mevcut literatüre dayanarak bu kurumların dini yaşam, eğitim, toplum ve Bursa ekonomisi üzerindeki etkisinin değerlendirilmesini de kapsamaktadır. Daha önceki araştırmalar Osmanlı döneminde Bursa'yı ve temellerini araştırmış olsa da, bu çalışma Bursa vakıflarının sosyal işlevlerini araştırmak için daha kapsamlı arşiv belgeleri kullanılarak yapılmasıyla öne çıkmaktadır. Bu araştırma, bu nedenle, Bursa'nın temel kaynaklara dayalı temelinin oluşturmada önemli bir rol oynamakta ve bu alandaki teorik gelişmelere önemli katkı sağlamaktadır. Ayrıca, Bursa vakıflarının mevcut literatür merceğinden kapsamlı ve titiz bir analizini yaparak gelecekteki araştırmalar için yeni bir bakış açısı sağlayacak ve böylece sosyal işlevlerine ışık tutacaktır. Çalışma, vakıf arşivlerinin, resmi, yarı resmi ve ticari kuruluşların faaliyetlerine ilişkin kayıtlar ve belgeler, tarih için depo görevi gören paha biçilmez kaynaklardır. Kullanılan araştırma metodolojisi, niteliktedir ve ilgili bilgileri içeren yazılı belgelerin titizlikle incelenmesini içeren birincil literatür ve belge analizine odaklanır. Bu nedenle belgeler, nitel araştırmalarda etkin bir şekilde kullanılması gereken çok önemli bilgi kaynaklarıdır. Bu çalışmada, ilgili literatürü incelemek için değerlendirici veya analitik yöntemler kullanılmıştır. Araştırmamızın kapsamı Bursa'nın merkezinde inşa edilen camiler, tapınaklar, medrese, türbeler, kütüphaneler, imaret, kervansaray, pansiyonlar, hamamlar, su kemerleri ve köprüler gibi çeşitli kuruluşları kapsamaktadır. Ayrıca araştırma, darphane gibi kuruluşların faaliyetlerini de içermektedir. Osmanlı vakıflarına ilişkin literatür, Bursa'da kurulan vakıfların genel kayıtlarının kapsamlı bir incelemesini içeren bu araştırmanın temelinin oluşturmaktadır. Bu kayıtlar, kurucular, tüzükler, hizmetler, çalışmalar, kalite, yapı, çalışma ilkeleri, görevler, liderlik, gelir, giderler, diğer vakıflarla ilişkiler ve Bursa'nın kent yaşamına katkıları hakkında bilgi sağlar. Fazlalığı önlemek için dipnotlar, yalnızca konu iyice aydınlatıldıktan sonra benzer nitelikteki literatüre atıfta bulunulmuştur. Osmanlı döneminde Bursa'nın ilçe, komünleri, kasaba ve köylerinde kurulan vakıflar kapsam dışında bırakılmıştır. Çünkü odak



noktamız esas olarak Bursa şehir merkezindeki vakıflar etrafında toplanmaktadır. Sınırlı bilgi mevcut olması ve net bir kuruluş statüsü olmaması nedeniyle ele alınamamıştır.

Bursa vakıfları üzerinde tezler, makaleler ve çalışmalar da dâhil olmak üzere daha önce araştırmalar yapılmıştır. Bu alanda dikkat çeken eserler arasında Osman Çetin'in "Yüzyılın İlk Yarısında Bursa Vakıfları" konulu yüksek lisans tezi ve Hasan Telli'nin sanat tarihi ve mimarlık perspektiflerinden içgörüler sunan "Osmanlı Döneminin Bursa Temelleri" konulu doktora çalışması yer almaktadır. Ayrıca Aysemin Çanak'ın doktora tezi Emir Sultan'ın temellerini araştırırken, Fatma Kırçıl Akkoç'un yüksek lisans tezi de Bursa'daki vakıflardan bahsetmektedir. Cafer Çiftçi'nin "Bursa'daki Vakıfların Sosyo-Ekonomik İşlevleri" konulu doktora tezi, Bursa tarihinin anlaşılmasına önemli katkılar sağlamıştır. Diğer bilimsel çalışmalar, kitaplar, tezler ve makaleler de farklı boyutlarda Bursa vakıflarına değinmektedir. Türk Medeni Kanunu'na göre vakıflar, belirli ve sürekli bir amaç için mülkiyet ve hak sağlayan gerçek veya tüzel kişilerden oluşan yasal kuruluşlardır. Vakıflar, uzun süredir devam eden yardımseverlik ve dayanışma duygusunu kurumsallaştırır. Türk Medeni Kanunu uyarınca kurulan ve faaliyet gösteren vakıflar, 5737 sayılı Vakıflar Kanunu uyarınca "yeni vakıflar" olarak adlandırılmaktadır (T.C. Resmi Gazete, 2008, sy. 26800). Vakf terimi, Arapça'dan gelir ve hapse atıfta bulunan tutma, durma, ayakta durma, kısıtlama ve bağlama kavramlarıyla anlamsal bir bağlantı oluşturur. Vakf teriminin çoğul biçimleri ise "evkâf" ve "vukûf"tur. Vâkıf terimi vakfeden, mevkûf ise vakfedilen şeydir. Vakıf, bir kişiyi, mülkü veya parayı insanların yararına, satın alma veya satma yapmadan, yalnızca Allah'ın yararına hapsetme eylemini tanımlar (Furat, 2012, s. 62). Bir örgüt, vakıf olarak lanse edilmesi için belirli temel özelliklere sahip olmalıdır. Bunlar arasında vakıfta bir irade oluşması, kalıcı nitelikte olması, varlıklarının geri alınmaz ve yeniden kullanılamaz olması, yasal statüsü mevcudiyeti ve vakfin geri ödemesinin olmamasıdır (Arslan, 2019, s. 185). Bursa vakıflarını incelediğimizde bu vasıflara haiz olduğu görülmektedir. Vakfın kökeni, insanlık tarihinin ayrılmaz bir parçası olan derin bir yardımseverlik duygusuna dayanmaktadır. Bununla birlikte, hukuki ve sistemik doğrultuda baktığımızda, Hz. Muhammed zamanından önceki dönemde yapılan yardım hizmetlerini sadece kurucu kuruluşların eylemleri olarak değil, aynı zamanda devlet ve çeşitli sivil toplum kuruluşları tarafından sağlanan hizmetler olarak değerlendirmek daha uygundur (Yapıcı, 2013, s. 68).

### **Vakfın Bileşenleri ve Gereksinimleri**

Vakfi oluşturan bileşenler dört unsura ayrılır ve bu unsurlar içinde belirli koşulların yerine getirilmesi gerekir. Bu koşullar yerine getirildiğinde vakıf aslına uygunluk ve geçerlilik kazanır (Vakıflar Genel Müdürlüğü, 2020, s. 184).



Vakıf: Vakfi kuran bireye kurucu denir. Vakfin gerçek ve etkili olarak kabul edilebilmesi için, kurucunun zekâ, olgunluk, özgürlük ve ayrıcalık niteliklerinin yanı sıra üretme ve ihsan yeteneğine sahip olması gerekir. Bir kişinin vakfi kurmaya zorlandığını veya zorlandığı konusunda herhangi bir iddia, vakfi temelden yoksun kılar. Vakfin gerekliliklerinin yerine getirilmesi, batıl inanç koşulları içermedikçe şeriat ilkelerine göre yasal bir hüküm olarak kabul edilmesi gerekir (Telli, 2020, s. 198).

Vakıf: Tahsis edilen varlıklar bağışı oluşturur. Buna göre, bağışlanan varlıklar, vakıf tarafından aranan geçim gereklilikleriyle uyumlu olmalı ve karşılığı bulunmalıdır. Yani kullanılabilir, yasal aynı zaman da şeriat hükümlerine uygun mevcut varlıklar olmalıdır. Mevcut varlıkların mülkiyetinin tamamının vakfin yetkisi altında olması gerektiği ve örneğin caminin ancak aynı şekilde kullanılabileceği kabul edilmektedir. Okul ve kütüphane gibi vakıflar söz konusu olduğunda, açıkça belirtmeli ve hisseli olmamalıdır (Beşirli, 2010, s. 33).

Mevkûfun aleyh: Bu, vakfin adına kurulduğu kişi veya bireyleri ifade eder. Bu bireyler, yoksullar, alimler, savaşçılar, camiler ve dini okullar gibi spesifik veya spesifik olmayanlardan oluşur. Hukukçulara göre, bilinen veya bilinmeyen, Müslüman veya gayrimüslim, yakın veya uzak olanlar da dâhil olmak üzere bir veya daha fazla kişi için bir vakıf oluşturmak caizdir. Gelecek nesiller için bir temel oluşturmaya da izin verilir. Örneğin Ebu Yusuf, vakfin kendisi tarafından kurulan bir vakfi kabul edilebilir görmektedir (Sırım, 2018, s. 23).

Vakfin beyanı veya adanması: Kurucu tarafından adanma amacıyla yapılan ve kaydedilen beyanlara vakfin beyanı (sigası) denir. Hanefî düşünce okuluna göre, birey “Benim toprağım yoksullar için sonsuz bir sadaka” veya “Allah adına adanmıştır” veya “insanlığın ve ruhun iyiliği için bir kurumdur” diyebilir. Öte yandan Ebu Yusuf, bir vakfin gerçek sayılması için “benim vakfım” veya “o bir vakıf” demenin yeterli olduğunu iddia etmektedir (Şensoy, 2016, s. 48).

Bursa'da vakıfların kurulması sırasında İmam Ebu Yusuf'un bakış açısının ağırlıklı olarak takip edildiği görülmüştür. Bursa'da Karlılı Mehmed Paşa, Memed bin Osman, Hafız Sabri Efendi ve Şafizade Seyyid Sadi Efendi gibi vakıfların kurucuları para ve dükkân şeklinde bağış yaptı. Ancak daha sonra bu bağışları geri çekmeye çalıştılar, lakin talepleri mahkeme tarafından reddedildi (Özer, 2006, s. 272).

### **Bursa'da Vakıf Çeşitleri**



Bursa'daki vakıflar niteliklerine, mülkiyetlerine, yönetim haklarına, taşınır veya taşınmaz mallarına ve kiralanıp kiralanmadıklarına göre çeşitli türlerde sınıflandırılır. Bu bağlamda vakıf türleri dört ana gruba ayrılabilir (Altun, 2022, s. 588).

### **Mahiyeti bakımından vakıf çeşitleri**

Hayrî vakıflar: Müessesât-ı hayriye ve gelirinden faydalanılan vakıflardan oluşur. Zürrî vakıflar ise tam zürrî vakıflar ve yarı zürrî vakıflardır.

### **Mülkiyeti bakımından vakıf çeşitleri**

Sahih vakıflar ve gayr-i sahih vakıflardan oluşmaktadır. Bursa'da vakıflar büyük oranda Sahih vakıflardan oluştuğu görülmektedir (Altun, 2022, s. 589).

### **İdaresi bakımından vakıf çeşitleri**

Mazbut vakıflar, mülhak vakıflar, müstesna vakıflar, icareteynli vakıflar, mukataalı vakıflar şeklindedir.

### **Hukukî bağlayıcılığı bakımından vakıf çeşitleri**

*Lazım vakıflar ve gayr-i لازم vakıflardan oluşmaktadır.* Bursa'da kurulan vakıfların لازم vakıflar olduğu görülmektedir (Altun, 2022, s. 589).

### **Toplumsal Cinsiyet Açısından Vakıf Kurucuları**

Bazı vakıf kategorileri kadın vakıflarından yoksundur. Açıklayıcı örnekler, bilim adamlarını, zanaatkarları ve tüccarları kapsar. Bununla birlikte, bu gruplarda kadınların yokluğu statülerinin yokluğu anlamına da gelmez. Örneğin, temel belgelerde bahsedilen “Şeyh” ve “Derviş” gibi terimler mezhebin eril büyüklerine aittir. Bununla birlikte, kadınların tasavvufa ilgi gösterdiği de kabul edilmektedir. Kendilerini belirli bir dini mezhebe bağlamaları buna bir örnektir. Osmanlı toplumunun, ataerkil yapısı nedeniyle genel olarak erkek odaklı bir nitelik sergilediğini belirtmek gerekir. Bu kapsamda temelleri dikkate alınarak kapsamlı bir değerlendirme yapılmıştır (Akkoç Kırçıl, 2010, s. 41).

Kadınlar tarafından kurulan 271 vakıfın 261'i kadın vakıf statüsüne haizdir. Bu sayısal eşitsizliğin nedeni daha önce tanımlanmıştır. Bu vakıfları kuran kadınlardan bazıları, padişahların eşleri, anneleri ve kızları ile vazo ve kolye bağışlama imkanına sahip kadınlardan oluşmaktadır. Hedefin Allah'a yaklaşmak ve O'nun rızasını almak olduğu göz önüne alındığında, bireylerin statüsü ve zenginliği üzerinde herhangi bir sınırlama yoktu. Aksine yöneticiler cömertlik gösterir ve tebaalarını bu konuda cesaretlendirdiler (Demirel, 2006, s. 60). Kadınların aksine, erkekler tüm kategorilere dâhildir. Sonuç olarak, araştırma döneminde, erkeklerin vakıf kurmada kadınlara kıyasla daha fazla aktivite sergiledikleri ortaya



çıkılmaktadır. 16. yüzyıl Osmanlı toplumundaki kadınların statüsü göz önüne alındığında, bu durum hafife alınmamalı gerekir. Erkek egemen toplumlarda kadın oranı oldukça yüksektir (Gürsoy ve Öz, 2022, s. 574). Bu egemenlik sayesinde, kadınlar artık yalnızca ev içi alanda sınırlı kalmıyor ve dış dünyayla bağlantı kuruyorlar. Ekonomik olarak güçlendirilmiş bu kadınların çoğunluğunun emekle meşgul olduğunu varsaymak yanlış olmaz. Bu faktör toplumsal konumlarını güçlendirmiştir. Hatta çok sayıda vakıf kadınları vakıf yöneticisi olarak atamaktadır. Alternatif olarak, bu sorumluluk zaman zaman eşleri tarafından da verilmiştir. Bu, hem bireylerin kendilerine, eşlerine hem de genel olarak topluma olan güveni gösterir. Mütevelli, vakfın tüm idari işlerinden sorumluluk aldığından, bu rolü gerekli niteliklere sahip kişilere emanet etmek zorunludur. İncelenen vakıf belgelerine göre, kadınların dini ve hayırsever faaliyetleri erkeklerden daha fazla tercih ettikleri açıktır. Bu durum, vakfın mütevelli heyeti aracılığıyla yürütülen işlerinin azami özenle ele alınması gerektiğini göstermektedir. Vakfın uzun vadeli yaşayabilirliğini tehlikeye attığı için dolandırıcılık ve yolsuzluk vakalarına müsamaha gösterilmemelidir (Polat, 2020, s. 126).

### **Vakıfların Sosyal ve Bütünsel Fonksiyonları**

Sosyal güvenlik ve sosyal yardım; vakıflar tarafından savunmasız kişilere ve genel olarak topluma sunulan hizmetler, diğer kişisel yardımlardan ve mevcut sosyal yardım ve güvenlik hizmetlerinden önemli ölçüde farklıdır.

Sosyal sorumluluğun kazanılması; sosyal refah alıcıları ve vakıflar aracılığıyla sağlanan fonlar karşılıklı duyguları paylaşıyorsa, kuşkusuz her iki tarafta yabancılaşmanın önlenmesine ve böylece sosyal sorumluluğun sağlanmasına katkıda bulunabilir.

Ekonomik yapı; sosyal devletler, ekonomik yapıdaki bireyler arasındaki gözle görülür farklılıkları en aza indirmek için sosyal yardımlara ve politikalara güvenir.

Gelir ve servet dağılımı; varlıklı kişilerin mülkiyeti, vakıflara ait kişisel mülkiyeti olmaktan çıkar. Bunun yerine, artık yalnızca düşük gelirli nüfusa fayda sağlamayan sosyal yaşamın mülkü haline gelir.

Sınıf çatışmalarının önlenmesi; insan sevgisine ve hoşgörüyü öncelik veren kuruluşların istihdam kalıplarını olumlu yönde şekillendirecektir.

İstihdama Katkısı; modern dünya koşulları altında örgütlenen vakıflar, gerekli istihdama fırsatlarını teşvik edecek ve yüksek kaliteli bir işgücünü sağlayacaktır.



Eđitime katkısı; vakıfların eđitim kurumları olarak hizmet edebileceđi ve eđitimin ilerlemesine katkıda bulunabileceđi açıktır. Ayrıca, vakıflar işletmeler içinde mesleki eđitim faaliyetlerine etkin bir rol oynayabilecektir.

Dengeli kalkınmanın sağlanması; vakıflar, az gelişmişliđin ortadan kaldırılmasında ve dengeli kalkınmanın sağlanmasında yararlı ve destekleyici bir rol oynayabilir. Gelişmekte olan ülkelerin karşılaştığı çıkmazın bir çözümü, varlıklı insanların gelir ve servetinin bir kısmını girişimcilik hedeflerini ve kâr amaçlı çabalarını engellemeden sosyal hizmetler sunmaya ayırmaktır.

Diđer işlevleri; vakıflar çok çeşitli işlevlere sahiptir ve ekonomik ve sosyal yapıyı olumlu yönde etkiler. Vakıflara bađış yapanlar huzur ve mutluluk yaşarlar. Aile vakıfları eđitim ve ailenin korunmasında önemli katkı sağlar.

### **Bursa'da Hizmet Amaçlı Vakıfların Kurucuları ve Sosyal İşlevi**

Bu bölüm, yukarıda bahsedilen vakıfların kurulmasına ilişkin konuları ve ön koşulları ele almaktadır. Ancak, bu bağlamda bazı zorluklar ortaya çıkmaktadır. Tıpkı belirli bađışların birden fazla kategoriye girebilmesi gibi, katkılar tek bir hizmet alanıyla sınırlı olmamalı, bunun yerine birden fazla alana yayılmalıdır. Bazı vakıflar, fon tahsis etmeyi düşündükleri belirli alanlarla ilgili herhangi bir bilgi vermemektedir. İncelenen vakıflar arasında dokuzu vakfın amacına ilişkin herhangi bir koşul getirmemektedir. Bu gibi durumlarda vakıf amaçlandığı gibi çalıştığı görülmektedir (Demirel, 2006, s. 69).

### **SONUÇ**

Para Vakfı, hem mali kaynakları hem de sunduđu hizmetlerle Osmanlı Devleti'nin sosyal ve ekonomik dokusuna kayda deđer katkılar sağlayan bir kuruluştur. Bu vakıf, sosyal hizmetlerin sürekli ve ücretsiz sağlanmasına adanmıştır.. Dünya çapındaki vakıfların çođu, gıda, barınma, sađlık, eđitim ve dine odaklanan beş temel hayır işi kategorisi çerçevesinde faaliyet göstermektedir. Etkili hayırsever yönetimin ayırt edici özelliđi, geniş bir birey yelpazesine önemli faydalar sağlamasıdır. Lakin vakıf yardımı alanların vakfın kurucusunun akrabaları olması yaygındır. Osmanlı İmparatorluđu'nun vakıf hizmetleri, modern refah devletinin desteđi ve yardımı ile ihtiyacı olanların refahının artırılmasında önemli bir rol oynamıştır. Örneđin finansal altyapı sistemi, kurumsal sermaye ve mikro kredinin çağdaş uygulamaları için bir model olarak düşünülebilir. Vakıfların işlevleri İslam hukukçuları arasında aralıklı olarak tartışmaya konu olmasına rağmen, vakıf örgütleri sosyo-ekonomik çerçeve içinde sürekli ve farklı varlıklar olarak faaliyet göstermiştir. Osmanlı döneminde eđitim, sosyal refah, kamu projeleri, sađlık ve dini girişimler gibi çok sayıda faaliyet parasal vakıflar



tarafından koordine edilmiş ve finansı sağlanmıştır. Halen Osmanlı Devleti'nin eğitim hizmetleri, devlete yük getirmeden sosyal güvenliğin sağlanmasında da önemli rol oynayan vakıflar tarafından finanse edilmektedir. Bir vakfın yetersiz sermayesi olduğu durumlarda, mevcut kurumsal sermaye artırma sistemine benzer bir yaklaşım uygulanmıştır. Spesifik olarak, katkılar artırılarak veya değerini artırarak istenen sermaye seviyesine ulaşılmıştır. Vakıflar ve ticaret birlikleri gibi kuruluşlar, istihdama fırsatlarını kolaylaştıran yöneticiler tarafından denetlenir. Bu kuruluşlar, işsizlik sorununa bir çare olarak istihdama yaratma önlemlerini aktif olarak destekleyerek ekonomiye katkıda bulunmuştur.

## KAYNAKÇA

- Akkoç Kırçıl, F.** (2010). *Mahkeme sicillerine göre XVI. yüzyılın ikinci yarısında (1150-1565) Bursa vakıfları*, (Yüksek Lisans Tezi). Uludağ Üniversitesi Sosyal Bilimler Enstitüsü, Bursa.
- Altun, F. G.** (2022). Sultan II. Murad'ın Bursa Vakfiyesi, *Uludağ Üniversitesi İlahiyat Fakültesi Dergisi* 31(2), 583-623.
- Arslan, O.** (2019). Türk Medeni Kanunu'na Göre Kurulan Vakıfların Ekonomik Yapısı ve Gelir Kaynakları, *Akademi Sosyal Bilimler Dergisi*, 6 (17), 184-196.
- Beşirli, M.** (2010). Vakıf Kurumunun Önemi ve Tokat'ta Hamza Bey Evkafı Üzerine Bazı Bilgiler, *History Studies*, 2(1), 1-13.
- Demirel, H.** (2006). Mahkeme sicillerine göre XVI. yüzyıl ilk yarısında Bursa vakıfları, (Yüksek Lisans Tezi). Uludağ Üniversitesi Sosyal Bilimler Enstitüsü.
- Furat, H. A.** (2012). İslam Hukukunda Vakıf Akdinin Bağlayıcılığı, *İstanbul Üniversitesi İlahiyat Fakültesi Dergisi*, (27), 61-84.
- Gürsoy, Ç. ve Özdeğer, M.** (2022). Ebediyete Bağış: Balat Şer'iyye Sicillerinde Para Vakfı Kayıtları (1555-1838), *Bellekten*, 86(306), 568-601.
- Kıvrım, İ.** (2019). Mahalle Avârız Vakıfları (17. Yüzyıl Ayntab Örneği). *Gaziantep Üniversitesi Ayıntâb Araştırmaları Dergisi*, 2(2), 34- 49.
- Özer, M.** (2006). *Üsküp'te Türk Mimarisi (XIV.-XIX Yüzyıl)*, Ankara: TTK. Yay.,
- Polat, S.** (2020). Osmanlı Toplum Hayatında Statü Sahibi Bir Kadın: Hacı Hafize Hanım, *Tokat Gaziosmanpaşa Üniversitesi Sosyal Bilimler Araştırmaları Dergisi*, Sonbahar Özel Sayı, 124-133.
- Sırım, V.** (2018). Bir Finansman Kaynağı Olarak Vakıflar: Osmanlı Örneği, *Osmanlı Medeniyeti Araştırmaları Dergisi*, 4(6), 22-36.





- Şensoy, F.** (2016). Osmanlı İmparatorluğu'nda Vakıfların Ekonomik Boyutları. *Muhasebe ve Finans Tarihi Araştırmaları Dergisi*, 10, 41-63.
- Telli, H.** (2020). Vakıf Belgelerinde İmâm-ı Âzam Ebû Hanîfe ve Görüşleri: Makedonya Vakfiyeleri Örneği, *Amasya Theology Journal*, 15, 453-492.
- T.C. Resmi Gazete** (2008). 5737 Sayılı Vakıflar Kanunu, 27/02/2008 tarih ve 26800 sayı.
- Vakıflar Genel Müdürlüğü.** (2020). Vakıf Deyimleri ve Terimleri Sözlüğü". <https://www.vgm.gov.tr/kurumsal/tarihce/vakif-deyimleri-veterimleri-sozlugu#dic26> adresinden alındı.
- Yapıcı, H.** (2013). İslam Tarihinde Vakıf Kültürü Üzerine Bir İnceleme, *Sosyal Bilimler Araştırmaları Dergisi*. I, 66-76.



## DETERMINATION OF THE TOXICITY LEVEL OF NICOTINE FROM INHALED CIGARETTE USING ALBINO RAT

Usman SANI KK

Dr. Abubakar LAWAL

Department of Pure & Industrial Chemistry, Faculty of Natural and Applied Sciences, Umaru Musa Yar` adua University, P.M.B. 2218 Katsina, Nigeria

### ABSTRACT

Tobacco smoke consists of thousands of compounds including nicotine. Tobacco smoking has been reported to be associated with increased risk of cardiovascular disease and cancer, particularly of the lungs. In spite of extensive research on the health effects of tobacco smoking, the substances in tobacco smoke exerting these negative health effects are not completely known. Nicotine is the substance giving the subjective pleasure of smoking as well as inducing addiction. In this study we have found the toxicity level of inhaled nicotine in cigarette using albino rats as a secondary smoker by inhaling the rats the cigarette for a short period of time and then sacrifice them in order to harvest the organs of interest (lung, liver, kidney as well as their blood), the sample are digested and extracted using QuEChERS dSPE process and are further analyzed using UV-visible spectrophotometer in order to record the absorbance of the samples. Calibration curve has made using the absorbance of standards in order to obtain the liner equation of the graph for estimation of the actual concentration. The results are found to be that the toxicity level of nicotine is highly affected to human due to the high concentration present in the organs, The actual results obtained, CMT LNG has the maximum concentration of nicotine residue ( $101.55 \pm 0.0007 \text{ mg/kg}$ ) while the CMT K, CMT B and CMT LI are found to be non-detectable (ND), and this shows that during the process, the nicotine accumulates the lungs completely. With this, it justifies that exposing yourself near primary smokers (people smoking tobacco cigarette directly) containing nicotine may result in health-related issues such as lungs cancer, cardiovascular diseases etc., in both primary and second-hand smokers.

**Keywords:** Nicotine, albino rats, cigarettes, tobacco, QuEChERS dSPE.

### INTRODUCTION

Smoking is a chronic disease with a recurring character, one of the oldest habits on the globe but also a problem of modern society, which kills more than 8 million people each year. More than 50% of those deaths are the result of direct tobacco use, while around 1.2 million are the result of non-smokers being exposed to second-hand smoke (WHO, 2021). Nicotine addiction must be seen as a chronic disease, with numerous periods of relapse and remission, and is mandatory that the clinician must treat it properly (Picciotto and Kenny, 2013).



Beside nicotine is the main alkaloid found in tobacco leaves, accounting for about 95% of the total alkaloid content, which are used in the production of cigarettes, cigars or flake tobaccos with content varying from 1 to 30 mg/g (Stočes, and Švancara, 2014). Currently, more than 1.2 billion people worldwide consume different tobacco products that results in nicotine addiction (Wu., et al 2009). The regular intake of nicotine through smoke of the burning tobacco products is toxic for both active and passive smokers and can cause several negative outcomes in human health such as cardiovascular, respiratory, central nervous diseases and even cancer (Levent., et al 2009). This enormous consumption of tobacco products worldwide leads to around 4.9 million deaths per year. Absorption of nicotine can be through the oral intake, lungs, urinary bladder, gastrointestinal tract, and its base form can be also easily absorbed through the skin, and can cause a poisoning in a contact with nicotine containing pesticides too (Irena, 2005). Therefore, several products are proposed as a replacement therapy to avoid tobacco consumption and to quit smoking. Such products include nicotine in the form of a nicotine chewing gums, nicotine patches, and nicotine tablets (Hannisdal, et al 2007).

Nicotine from inhaled combustible cigarette smoke is delivered rapidly to the brain, and sufficient unbound nicotine concentrations exert pharmacological effects. In addition to nicotine, combustible cigarette smoke also contains a significant number of toxicants that trigger perturbations, leading to an altered steady state due to differential expression of proteins. There are recorded millions of cases of insect infestations and other related diseases annually (Kolli et al., 2023).

### **Nicotine**

Nicotine is the main component of tobacco smoke, and failure to quit smoking is virtually attributed to its addictive potential, which is similar to that of opium and alcohol (Henningfield et al., 1989). It is known that smokers are relatively having a higher morbidity and/or mortality rate than non-smokers. Exposure to environmental tobacco smoke (ETS) “passive smoking” is also harmful to non-smokers` (Knudson et al, 1989a). The US environmental protection agency (EPA) classified ETS as a class-A carcinogen, as they are highly susceptible to cancer (Benowitz, 1986). Burning of tobacco generates about 4000 components, the most famous one of them is the tar which is a dark brown material, contains all the particulate phase of the smoke that includes nicotine, phenols, hydrocarbons, aldehydes, ketones, organic acids, and alcohol. Nicotine, is colorless, volatile, and highly toxic natural liquid alkaloid that turns brown and acquires the dour of tobacco on exposure to air. Nicotine is rapidly and extensively metabolized in the liver, and to a lesser extent in the lungs and kidneys (Gorrod and Jenner, 1975). Renal excretion of nicotine accounts for about 70-75 % of total elimination (Rosenberg, et al., 1980). Nicotine is also excreted in the milk of lactating women who smoke (Goodman and Gilman, 1991). Nicotine has a diver’s effect on most if not all the body organs and/ or systems including respiratory system (Dalbey et al, 1980), cardiovascular system (Benowitz, 1988), central nervous system and skeletal muscles (Benowitz 1986), endocrine system (Goodman and Gilman, 1991), bone minerals (Daniell 1976), urinary system (Auerbach and Garfinkell, 1989), and male and female genital systems (Kaufman 1980), (Chang and colleagues, 1990) have noticed a prominent loss of the gastric mucosa, with bleeding ulcers in nicotine treated animals. Moreover, cigarette smoke could inhibit pancreatic and hepatic bicarbonate secretion (Konturek et al., 1971) (Dubick and co-workers 1987-a) have



reported that cigarette smoking could increase the content of digestive enzymes in the pancreas, as well as their basal and secretagogue induced release. In addition to nicotine, tobacco smoke contains other cytotoxic agents, which could affect the exocrine pancreatic function (Sanakaran et al., 1985). Several studies have evaluated the pharmacological, biochemical and pathological changes induced by cigarette smoking and nicotine.

### **Mode of Action of Nicotine**

Nicotine dependence involves complex interactions between nicotine and the brain's reward system. When nicotine is inhaled or consumed, it quickly reaches the brain and binds to nicotine receptors, primarily in the areas of the brain associated with reward, pleasure, and motivation. Nicotine stimulates the release of dopamine, a neurotransmitter that plays a crucial role in the brain's reward system. This leads to feelings of pleasure and reinforcement, reinforcing the desire to repeat the nicotine intake. Over time, the brain adapts to the presence of nicotine and adjusts its functioning. The brain may reduce the number of nicotine receptors or alter the sensitivity of existing receptors. This adaptation can lead to tolerance, where higher doses of nicotine are required to achieve the same effects (neuroadaptation). With regular nicotine use, the brain becomes accustomed to functioning with nicotine present. When nicotine levels drop, withdrawal symptoms may occur, including cravings, irritability, anxiety, difficulty concentrating, and increased appetite. These withdrawal symptoms can drive continued nicotine use to alleviate discomfort. Nicotine use is often reinforced through associative learning. Environmental cues, such as specific locations or activities associated with smoking, can become triggers that elicit cravings and lead to smoking relapse. National Institute on Drug Abuse (Picciotto and Kenny, 2013).

## **MATERIAL AND METHOD**

### **Sampling and treatment**

A total of four (4) adult albino rats with an average weight of 154g were purchased from the Animal-House of Umaru Musa Yar'adua University Katsina, Nigeria. The rats were divided into 2 groups. However, each of the two (2) rats were kept in cages and named Group A and B, respectively. Each of the groups was placed in two (2) separate small rooms in an Animal-House with similar ventilation system. Later on, Group B (contaminant) rats were exposed with the smoke released by two individually burned cigarette (one after the other) for nine (9) hours, daily over a period of fourteen days (14) days. While, Group A (blank) were kept in a separate room and were not exposed to the smoke released by the burned cigarette for the same period of time. Subsequently, each of the animals from each group was sacrificed and its organs (lungs, kidney and liver) were harvested using dissection equipment and preserved in separate labeled sample bottles. Also, the blood samples were individually collected using a syringe and preserved in the labeled sample bottles. Then, all the 8 analytical samples (1 sample of blood, lungs, kidney and liver for the 2 exposed and 2 unexposed animals) in the labeled sample bottles were preserved in a refrigerator before extraction of the nicotine residue using the QuEChERS-dSPE techniques (Lawal and Ibrahim 2023).

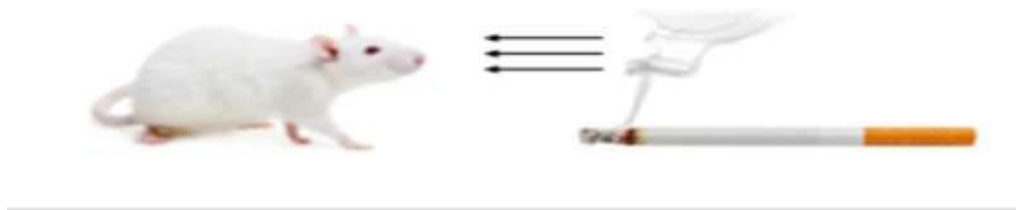

**Figure 1: Illustration of inhalation of cigarette by albino rats.**

**Sample preparation**

The validated method of QuEChERS - dSPE (Quick, Easy, Cheap, Effective, Rugged, and Safe) reported by (Lawal et al., 2018) as well as (Lawal and Koki 2019) was adopted for the sample extraction of the 8 analytical samples. The method started by transferring 2 mL blood sample for one of the blank group of animals into a 15 mL centrifuge tube and 5 mL of acetonitrile was added. Then, 1.8 g of anhydrous MgSO<sub>4</sub> (magnesium sulphate) and 0.45 g of CH<sub>3</sub>COONa (sodium acetate) salts were added. The mixture was vortexed for 1 min and centrifuged at 4000 rpm for 2 min. Afterward, the d-SPE extraction cleanup was carried out by transferring 1.5 mL supernatant from the QuEChERS extraction into 2 mL centrifuge tube containing 0.2 g MgSO<sub>4</sub>. The tube was vortexed and centrifuged (4000 rpm) for 5 min. The extract was analyzed with UV-visible spectrophotometry instrument at the wavelength of 350 nm (Alonso et al., 2014) and the absorbance readings were recorded. Note that, the method above was similarly used on the remaining analytical samples. Even though, the lungs, livers and kidneys samples were ground and homogenized before carrying out their respective sample preparations to increase their extraction processes. Also, the residual concentrations (mg/kg) of the targeted analyte were estimated using the linear equation (Eqn. 1) of the graph's calibration curve.

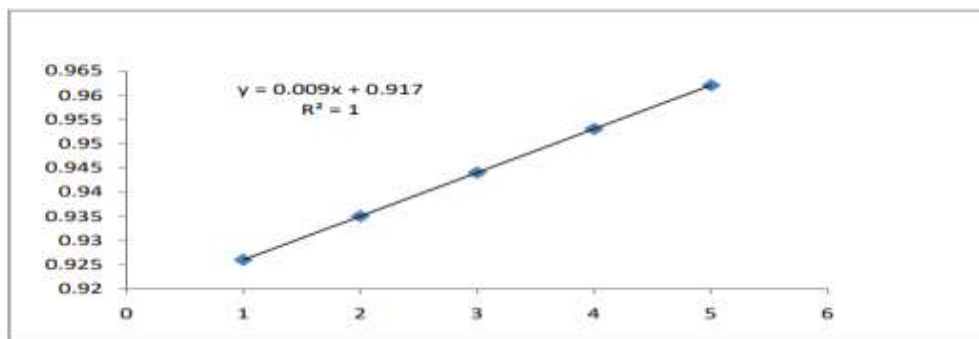

**Figure .2 illustrates the linearity of calibration curve**

The estimations of the actual concentration of Nicotine in the analyzed sample using the linear equation of the graph ( $Y = 0.009x + 0.917$ ) ..... (Eqn.1) and regression ( $R^2 = 1.0$ ) Which shows that the regression is above 0.97 and therefore the result considers to be suitable for calibration.



### Preparations of the Working Standard Solutions

The cigarette was bought at malam hamza tobacco deport sabon layi katsina. In which we measure the weight of the cigarette and then grind it for a proper dissolvment.

A stock solution of nicotine, (1000ppm) standard was prepared by dissolving 8.0g (25 sticks of cigarette) of analyte in 250mL of methanol in a conical flask for a period of 48 hours. From the stock solution, an intermediately stock solution of 100ppm to 500ppm was prepared by transferring 0.5mL of the prepared solution into 4.5mL of methanol as S1, 1.0mL into 4.0mL as S2, 1.5mL into 3.5mL as S3, 2.0 mL into 3.0mL as S4 and 2.5mL into 2.5mL as S5 to be 100ppm, 200ppm, 300ppm, 400ppm, and 500ppm in a white sample bottle respectively as the concentrations (Lawal & Koki, 2019). The standard solutions were preserved in sample bottles and placed in a refrigerator before using them to calibrate the UV visible spectrophotometry instrument (Lawal et al., 2021).

### Instrumentation

The UV-visible spectrophotometer single beam with matched quartz cell 1.0 cm and T60 model was used to analyze the blank and the prepared samples after the instrument was calibrated using the prepared stock/standard solutions of nicotine. All analyses were carried out in triplicates to determine the mean (average) and standard deviations (Lawal and Ibrahim 2023). All the readings were recorded at 300nm wave length.

### RESULTS AND DISCUSSIONS

The prepared standard solutions were analyzed and the average absorbance reading of the UV-visible instrument were used for the construction of the calibration curve after deducting out the blank readings as shown in Table 1

The calibration curve shows a straight line from the results obtained, that means it agreed with or obeys Beers Lambert law. The figure 1. illustrates the linearity of calibration curve was obtained in a concentration range from blank to 500ppm for nicotine (Lawal and Ibrahim 2023).

**Table .1- shows the calibration results obtained from the prepared standard solution.**

S/N	STANDARDS	CONCENTRATION	AV ABS	SDEV
1	S1	100ppm	0.926	0.0016
2	S2	200ppm	0.935	0.001
3	S3	300ppm	0.944	0.001
4	S4	400ppm	0.953	0.001
5	S5	500ppm	0.962	0.001



**Keys;** S1, S2, S3, S4, S5 = Standard 1, 2, 3, 4 and 5 respectivel

**Table .2: Average absorbance of the contaminated sample compares to absorbance of nicotine**

S/N	ORGANS	AV - ABS OF NICOTINE
1	CMT B	0.08
2	CMT K	0.137
3	CMT LI	0.305
4	CMT LNG	0.003

**Keys:** CMT B = contaminated rat blood, CMT K = contaminated rat kidney, CMT LI = contaminated rat liver, CMT LNG = contaminated rat lungs.

Meanwhile, the average absorbance readings for each sample organelles of the four animals from both blank and exposed group were successfully estimated from the equation of the calibration curve. Eventually, the average residues of Nicotine were determined in all the analyzed organelle samples and the average actual concentrations were estimated by deducting the average concentration of CONTAMINANTS group (Group A) from the average concentration of the BLANK group (Group B) as illustrated in Fig. 2 and presented in Table 3

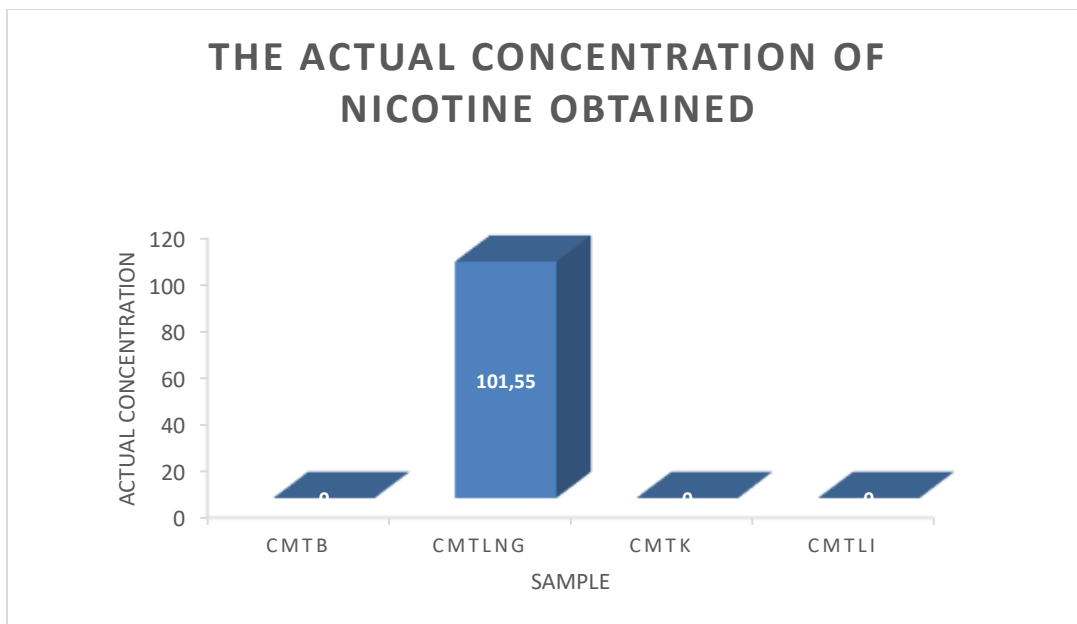



**Figure .3: Bar chart of the actual concentration of nicotine obtained from the analyzed contaminated samples.**

**Table .3; actual concentration of nicotine obtained**

S/N	SAMPLE	ACTUAL CONCENTRATION
1	CMTB	ND
2	CMTLNG	101.55±0.0007mg/kg
3	CMTK	ND
4	CMTLI	ND

**Keys;** ND = Not detected

Table 3: shows CMT LNG has the maximum concentration of nicotine residue (101.55±0.0007mg/kg) while the CMT K, CMT B and CMT LI are found to be non-detectable (ND), and this shows that during the process, the nicotine accumulates the lungs completely.

The result shows that CMT LNG has the highest concentration of (101.55±0.0007mg/kg) when compared with other samples being analyzed shown in (Table 3.1.3). This may occur as a result of the initially and continuous deposits of smokes containing the nicotine in the lungs tissue by inhalation process before circulating into the blood streams through the alveoli as documented (Song et al., 2019). The kidney, blood and liver are found to be undetectable. This maybe because of the lower concentration of the nicotine within the organelles (Vichare et al., 2010).

## CONCLUSION

The results obtained from this analysis show that exposing yourself near primary smokers (people smoking tobacco cigarette directly) containing nicotine may result in health-related issues such as lungs cancer, cardiovascular diseases etc., in both the primary and second-hand smokers.

## RECOMMENDATIONS

I recommend that public health policies be updated to reflect the risk of secondhand smoke exposure in the people living environment. This includes measures such as increasing public awareness of risks, banning smoking in public places and increasing the availability of smoke free environments. It also recommended that further researches should be carried out in order to understand the long-term effects of secondhand smoke exposure to the humans and animals in general.





## REFERENCES

- A. Hannisdal, Ø. Mikkelsen, K.H. Schröder, Analysis of nicotine in antismoking pharmaceutical products by differential pulse polarography and voltammetry, *Collect. Czech. Chem. Commun.* 72 (2007) 1207–1213
- A. Levent, Y. Yardim, Z. Senturk, Voltametric behavior of nicotine at pencil graphite electrode and its enhancement determination in the presence of anionic surfactant, *Electrochim. Acta* 55 (2009) 190–195.
- Aditya R. Kolli Florian Calvino-Martin, Arkadiusz K. Kuczaj, Ee Tsin Wong Bjoern Titz, Yang Xiang Stefan Lebrun, Walter K. Schlage, Patrick Vanscheeuwijck, Julia Hoeng: Deconvolution of Systemic Pharmacokinetics Predicts Inhaled Aerosol Dosimetry of Nicotine DOI: 10.1016/j.toxlet.2023.04.006
- Alonso, M. L., Laza, J. M., Alonso, R. M., Jiménez, R. M., Vilas, J. L., & Fañanás, R. (2014). Pesticides microencapsulation. A safe and sustainable industrial process. *Journal of Chemical Technology & Biotechnology*, 89(7), 1077-1085.
- Auerbach, O. and Garfinkell, L. (1989): Histologic changes in the urinary bladder in relation to cigarette smoking. *Cancer*, 64, 983-987.
- B.K. Irena, Facts about nicotine toxicity, *Arh. Hig. Rada. Toksikol.* 56 (2005) 363–371.
- Benowitz, N.L. (1986): Clinical pharmacology of nicotine. *Ann. Rev. Med.*, 37:21-32.
- Benowitz, N.L. (1988): Pharmacologic aspects of cigarette smoking and nicotine addiction. *The New England Journal of Medicine*, 319, 1318-1330.
- C.T. Wu, P.Y. Chen, J.G. Chen, V. Suryanarayanan, K.-C. Ho, Detection of nicotine based on molecularly imprinted TiO<sub>2</sub>-modified electrodes, *Anal. Chim. Acta* 633 (2009) 119–126.
- Chang, L.; Hosotaml, R. and Rayford, P.L. (1990): Metabolic and pathologic effect of nicotine on gastrointestinal tract and pancreas of rats. *Pancreas* 5, 222-229.
- Dalbey, W.K.; Nettleshein, P.; Caton, J.E. and Guerin, M. (1980): Chronic inhalation of cigarette smoke by F344 rats. *Natl Cancer Institute*, 64, 112- 118
- Daniell, H.W. (1976): Osteoporosis of the slender smoker. *Arch. Intern. Med.*, 136, 298-304.
- Dubick, M.A.; Contreas, C.N. and Billy, M.T. (1987-a): Raised serum concentrations of pancreatic enzymes in cigarette smokers. *Gut*; 28, 330-335.
- Goodman AG, Gilman SL (1991). *The pharmacological basis of the therapeutics*. Mac Millan Publishing Co. Inc., New York, 8th edition.
- Gorrod JW, Jenner P (1975). The metabolism of tobacco alkaloids. *Essays Toxicol. N. Y.*, 6: 35-78. <https://doi.org/10.1016/B978-0-12-107606-1.50008-2>
- Kaufman, M. (1980): Cigarette smoking and age at natural menopause. *Am. J. Public Health*, 70, 420-422.



- Knudson, R.J.; Knudson, D.E. and Kaltenborn, W.T. (1989a): Subclinical effects of cigarette smoking. *Chest.*, 95:512
- Kolli, A.R., Calvino-Martin, F., Kuczaj, A.K., Wong, E.T., Titz, B., Xiang, Y., Lebrun, S., Schlage, W.K., Vanscheeuwijck, P., Hoeng, J., 2023. Deconvolution of systemic pharmacokinetics predicts inhaled aerosol dosimetry of nicotine. *Eur. J. Pharm. Sci.* 180. <https://doi.org/10.1016/j.ejps.2022.106321>. [View publication stats](#)
- Konturek, S.J.; Solomon, T.E.; McGreight, W.G.; Johnson, L.R. and Jacobson, E.G. (1971): Effects of nicotine on gastrointestinal secretions. *Gastroenterology*, 60, 1098-1105.
- Lawal, A. & Ibrahim, U. (2023). Estimation of the Levels of Meperfluthrin Pesticides in the Body Organelles of Albino Rats through Inhaling Smoke Produced by Mosquito Coils. *ChemSearch Journal* 14(1): 14 – 20, June, 2023
- Lawal, A., & Koki, I. B. (2019). Determination of multi-pesticide residues in coconut water by QuEChERS-dSPE ionic liquid-based DLLME couple with high performance Liquid Chromatography-Tandem Mass Spectrometry (LCMS/MS). *ChemSearch Journal*, 10(1), 87-93.
- Lawal, A., Gwaram, N. S., Yerima, B. L., & Ibrahim, I. (2021). Determination of Sunset yellow as a synthetic food colorant in confectionery products consumed in Katsina metropolis (Nigeria) using UVVIS spectrophotometer. *FUDMA JOURNAL OF SCIENCES*, 5(1), 358-363.
- Lawal, A., Wong, R. C. S., Tan, G. H., Abdulra'uf, L. B., & Alsharif, A. M. A. (2018b). Recent modifications and validation of QuEChERS-dSPE coupled to LC-MS and GC-MS instruments for determination of pesticide/agrochemical residues in fruits and vegetables. *Journal of chromatographic science*, 56(7), 656-669.
- M. Stočes, I. Švancara, Electrochemical behavior of nicotine at unmodified carbon paste electrode and its determination in a set of refilling liquids for electronic cigarettes, *Electroanalysis* 26 (2014) 2655–2663.
- Picciotto, M.R., & Kenny, P.J. (2013). Molecular Mechanisms Underlying Behaviors Related to Nicotine Addiction. *Cold Spring Harbor Perspectives in Medicine*, 3(1), a012112.
- Rosenberg, J.; Bonwitz, N.L.; Jacob, and Wilson, K.H. (1980): Disposition kinetics and effects of intravenous nicotine. *Clin. Pharmacol. Ther.*, 28, 516-522
- Sankaran, H.; Lewin, M.B.; Wong, A. and Martin, L. (1985): Irreversible inhibition by acetaldehyde of cholecyst - tokenin induced amylase secretion for isolated rat pancreatic acini. *Biochem. Pharmacol.*, 34, 2859-2863.
- Snyder FR, Davis FC, Henningfield JE (1989): The tobacco withdrawal syndrome: performance decrements assessed on a computerized test battery. *Drug Alc Depend* 23:259–266
- Song, L. C., Chen, X. X., Meng, J. G., Hu, M., Huan, J. B., Wu, J., Xiao, K., Han, Z. H., & Xie, L. X. (2019). Effects of different corticosteroid doses and durations on smoke inhalation-



ATLAS 11. INTERNATIONAL  
CONGRESS ON ADVANCED SCIENTIFIC STUDIES AND INTERDISCIPLINARY RESEARCH

---

induced acute lung injury and pulmonary fibrosis in the rat. *International immunopharmacology*, 71, 392-403.

Vichare, V., Mujgond, P., Tambe, V., & Dhole, S. (2010). Simultaneous spectrophotometric determination of paracetamol and caffeine in tablet formulation. *International Journal of PharmTech Research*, 2(4), 2512-2516.

World Health Organization (WHO). (2021) Tobacco <https://www.who.int/news-room/fact-sheets/detail/tobacco>



**WOMEN AS TRADITIONAL MUSIC EDUCATORS AMONG YORUBA OF  
SOUTHWEST NIGERIA: LEARNING FROM THE PAST AND THE PRESENT  
TO PROJECT THE FUTURE**

**Julius Oluwayomi OLUWADAMILARE (Ph.D)**

Department of Music, University of Ilesa, Ilesa, Osun State, Nigeria.

**ABSTRACT**

In the African traditional societies, women have always played the role of teachers, albeit informally. This is evident in the upbringing of their babies. As mothers, they also serve as the first teachers to teach their wards lessons through day – to – day activities. Women also play the role of musicians during naming ceremonies, in the singing of lullabies, during initiation rites of adolescent boys and girls into adulthood, and in preparing their children especially daughters (and sons) for marriage. Furthermore, women perform this role during religious and cultural activities, chieftaincy title/coronation ceremonies, singing of dirges during funeral ceremonies, and so forth. This traditional role of the African/Nigerian women puts them at a vantage point to contribute maximally to the teaching and learning of music at every level of education. Therefore, this paper examines some selected Yoruba folksongs being used by women in the upbringing of their wards. This paper employs ethnographic method and Ethnomusicological analysis of the selected Yoruba Folksongs. The findings of the study revealed that women play prominent roles in the upbringing of their wards at every stage of their development as reflected in the selected folksongs. Therefore, this paper concludes that the values inherent in Yoruba folksongs should be sustained and utilized in the total upbringing of children while still undergoing Western System Education.

**Keywords:** Women, Womanhood, Traditional Music Education, Folksongs.



## 1960-1970 YILLARI ARASINDA TÜRKİYE-ABD İLİŞKİLERİ

TÜRKİYE-USA RELATIONS BETWEEN 1960-1970

Yusuf SAYAR

Doktora Öğrencisi, Kapadokya Üniversitesi

ORCID NO: 0000-0001-5756-0234

### ÖZET

Bu çalışma, Türk Dış Politikası açısından özellikle 1960-1970 yılları arasında gerçekleşen olaylar temelinde Türkiye ve Amerika Birleşik Devletleri arasındaki ilişkileri incelemeyi hedeflemektedir. Bu on yılda, Türkiye ve ABD ilişkileri dünya siyasetini belirlemede önemli bir rol oynamıştır. İkili arasındaki bağların SSCB-ABD Jüpiter Füze krizine ve nükleer savaş tehdidinde yol açması ile 1960ların başlarında Türkiye-ABD ilişkisinde soğukluk görülmüş, sonrasında ise Kıbrıs krizi ve Johnson mektubu ile gerilim tırmanarak artmıştır. 1970'e doğru ise 1965'ten sonra Türkiye'de hükümetin değişmesi ile birlikte Türkiye-ABD ilişkileri yeni bir boyut kazanarak iki devletin birbirine yaklaşımıyla yeni bir yola girilmişse de ortaya çıkan konjonktürde Türk Dış Politikası'nda radikal değişiklikler yapılarak, ABD ile ilişkilerde tek yönlülük sorgulanmaya başlamış ve Türkiye'nin Üçüncü Dünya (Bağlantısızlar) ve İslam ülkeleriyle ilişkileri geliştirilmeye çalışılmıştır. Bu çalışma da 1960-1970 yılları arasında geçen on yılda Türkiye-ABD ilişkilerini etkileyen, belirleyen ve yönlendiren etkenlerle bu sürecin çıktılarını inceleyerek döneme ışık tutacaktır.

**Anahtar Kelimeler:** Türkiye, Amerika Birleşik Devletleri, Türk Dış Politikası, Uluslararası İlişkiler.

### ABSTRACT

This study aims to examine the relations between Türkiye and the United States in terms of Turkish Foreign Policy, primarily based on the events that took place between 1960 and 1970. In this decade, the relations between Türkiye and the USA have played an essential role in determining world politics. There was political apathy in Türkiye-USA relations in the early 1960s, as the ties between the two led to the USSR-USA Jupiter Missile crisis and the threat of nuclear war, and then the tension escalated with the Cyprus crisis and the Johnson letter. Towards 1970, with the change of government in Türkiye after 1965, Türkiye-US relations gained a new dimension, and a new path was followed with the approach of the two states to each other. However, in the emerging conjuncture, radical changes were made in Turkish Foreign Policy, the one-sidedness in relations with the USA began to be questioned, and Türkiye's relations with the Third World (Non-Aligned) and Islamic countries were tried to be improved. This study will shed light on the period by examining the factors that affected, determined, and directed Türkiye-US relations in the decade between 1960 and 1970 and the outcomes of this process.



**Keywords:** Türkiye, United States of America, Turkish Foreign Policy, International Relations

## GİRİŞ

1960-1970 Türk dış politikası oldukça çalkantılı ve inişli çıkışlı ilişkilere tanıklık etmiş, bu dönemde uluslararası bağlamda gerçekleşen ikili ilişkiler ve olaylar Türkiye'nin Amerika Birleşik Devletleri ile olan ilişkilerini şekillendirmede büyük rol oynamıştır. 1960-1970 dönemindeki gelişmeleri ve ilişkileri analiz edebilmek için, dönemin öncesine kısa bir bakış atmak gerekir. II. Dünya Savaşı sonrasında Müttefik Devletlerin, Mihver Devletleri yenilgiye uğratması ile birlikte tüm dünya da yeni bir uluslararası ortam meydana gelmiştir. Savaş sırasında iki müttefik olan ve Mihver Devletlere karşı savaşta ittifak içinde bulunmuş olan Amerika Birleşik Devletleri (ABD) ile Sovyetler Sosyalist Cumhuriyetler Birliği (SSCB), Berlin'in işgalinden itibaren adım adım düşman taraflara dönüşmüştür. Sovyetler Sosyalist Cumhuriyetler Birliği'nin Avrupa'da hakim tek süper güç olarak kalması ve yayılcılık sinyalleri vermesi, ABD'nin Avrupalı müttefiklerini harekete geçirince, SSCB'ye karşılık ortaya çıkan güç boşluğunu doldurma ihtiyacına cevap olarak ABD'nin Avrupa'daki varlığının kalıcı hale gelmesi için zemin oluşmuştur (Bağcı, 2018, s. 131). Truman Doktrini ve Marshall Planı'nın uygulanmasının ardından ABD'nin Batı Avrupa'ya yönelik savunma stratejisi, 1949'da NATO'nun kurulmasıyla tamamen yeni bir boyut kazanmıştır. ABD Başkanı Harry Truman, Truman Doktrini'ni 1947'de ABD'nin komünizm tarafından askeri ve mali açıdan tehdit edildiğine inandığı ulusları teşvik etmek ve onlara yardım etmek için bir strateji olarak oluşturmuştur (Bağcı, s. 131). 1948 ile 1951 yılları arasında "Marshall Planı" olarak bilinen bir yardım girişimi bu doktrini hayata geçirmiş, bu doktrin kapsamında Amerika Birleşik Devletleri, aralarında Türkiye'nin de bulunduğu ülkelere ekonomik kalkınma yardımı sağlamıştır.

Demokrat Parti'nin (DP) 14 Mayıs 1950'de seçilmesinden sonraki süreçte Türkiye'nin dış politikasını etkileyen başlıca faktör SSCB'nin baskıcı ve yayılcı dış politikası olmuş, bunun sonucunda Türkiye güvenlik arayışına girmiş ve Batı Bloku ile yakınlaşmıştır. Bunun yanında Menderes Hükümeti, savaş sonrasında Türk ordusunun ve ekonomisinin zayıflamış durumu göz önüne alındığında, Batı Bloku'nun yanında yer almanın fayda sağlayacağını görmüş, bu bağlamda Menderes hükümeti bu konuda aktif bir duruş sergilemekten ve milletin çıkarlarına en çok hizmet edeceğine inandığı tarafı seçmekten yana olmuştur (Bağcı, s. 132).

Bu sırada, bu gelişmelere ek olarak global siyasette bir gelişme olan "Kuzey Atlantik Antlaşması Örgütü (North Atlantic Treaty Organization - NATO), ABD'nin liderliğiyle, Truman Doktrini'nin devamı niteliğinde Sovyetler Birliği'ni çevreleme politikası ve bu kapsamda Batı Avrupa'nın savunması amacıyla Şubat 1949'da kurulmuştur" (Bağcı, s. 133).



Türkiye, başlangıçta, Sovyetler Birliği'ne karşı doğuda bir güç boşluğu oluşacağı endişesiyle Batı Avrupa ülkelerinin savunması amacıyla kurulan NATO'ya alternatif olarak Doğu Akdeniz Bölgesi'nde Doğu Akdeniz Savunma Pakti'nin kurulması önerisini getirmişse de bu görüşün bir sonuca ulaşamayacağı anlaşıldığında bundan vazgeçmiş ve NATO'ya üyelik başvurusunu 11 Mayıs 1950 tarihinde Şemsettin Günaltay Hükûmeti'yle resmen yapmış, ne var ki bu başvuru “yetersiz demokrasi” gerekçesi ile kabul edilmemiştir. Türkiye'de 14 Mayıs 1950 tarihinde yapılan genel seçimlerle Demokrat Parti iktidara gelmiş ve NATO üyeliği ve dış politikada Batı ile yakınlaşma Adnan Menderes başbakanlığında kurulan hükümetin öncelikleri arasında yer almıştır. O dönemde, SSCB'den duyulan endişe son derece yoğundur ve ABD ile NATO aracılığı ile yakın iş birliği dışında başka ciddi bir alternatif de görülmemekte, Türk kamuoyunda da bu konuda herhangi bir itiraz bulunmamaktadır. Sorun NATO'nun, özellikle de onun lideri konumunda olan ABD'nin Türkiye'nin üyeliği için ikna edilmesidir. Bu arada Kuzey Kore'nin Güney Kore'ye saldırması sonucu patlak veren Kore Savaşı, Birleşmiş Milletler (BM) Güvenlik Konseyi'ni harekete geçirmiş ve Konsey üye ülkelerden Kore'ye yapılacak askerî müdahaleye katkı talep etmiştir. ABD'nin ardından Türkiye bu talebe karşılık veren ilk ülkeler arasında yer almış, gönderdiği bir tugayla savaşın en aktif katılımcılarından biri olmuştur. (Bağcı, s. 136)

Bu gelişmeleri takiben Kore'ye asker göndermeye karar veren Türkiye, bu kararın NATO üyeliğini olumlu etkileyeceği umuduyla 1 Ağustos 1950'de ikinci kez NATO'ya üyelik başvurusunda bulunmuş fakat bu başvurusu da Danimarka, Norveç ve İngiltere'nin itiraz etmeleri ile reddedilerek Türkiye'nin bu girişimi engellenmiştir. Yine de ilerleyen süreç Türkiye lehine olmuş, 15-21 Eylül 1951'de Ottawa'da yapılan NATO Bakanlar Konseyi toplantısında Amerika Birleşik Devletleri, Türkiye ve Yunanistan'ın üye olarak kabulünü desteklemek için diğer muhalif ülkeleri ikna çabasına girmiştir. “Nihayet Türkiye, 18 Şubat 1952 tarihinde NATO'ya resmen üye olmuştur. ... Türkiye, NATO'ya üye olduktan sonra “ortak düşman” algısı Türk dış politikasına da büyük ölçüde yansımış ve ülkenin genel çıkarları ile NATO'nun ve ABD'nin çıkarlarının özdeş görüldüğü bir dış politika anlayışı yerleşmiştir” (Bağcı, s. 137).

NATO'nun ABD Başkanı Dwight D. Eisenhower öncülüğünde 1953 yılında “Kitlesel Karşılık Doktrini”ni ilan etmesi bu bakımdan Avrupa'nın güvenliği için son derece önemli bir aşamayı ifade etmektedir. Kitlesel Karşılık Doktrini, ABD'nin 1954 yılında NATO'nun da askerî stratejisi olarak belirlenmiştir. İlan edilen bu doktrine göre Sovyetler Birliği ile girişilecek herhangi bir çatışmada, Sovyetler Birliği'nin kullandığı silahın türüne bakılmaksızın ABD ve NATO nükleer silahlarla mücadele verecektir. Bu strateji SSCB'nin nükleer silahlar konusunda kapasitesini geliştirmesi ve ABD'nin de nükleer tehdit altına girmesi ile değiştirilecektir. (Bağcı, s. 138)



## ARAŞTIRMA VE BULGULAR

### 1960'A DOĞRU

ABD, daha önce Sovyetler Birliği'ne uzaklığı nedeniyle bir nükleer saldırının hedefi olma endişesi taşımamış, ancak Sovyetler Birliği'nin 1957'de "Sputnik" uydusunu uzaya fırlatmasından sonra bunun olabileceğini anlamış ve sonuç olarak yeni "dehşet dengesi" durumu karşısında 'Kitlesele Karşılık Doktrini' yerine 'Esnek Karşılık Doktrini'nin benimsenmesi uygun görmüştür. Yeni politika doğrultusunda ABD ve NATO yeni bir strateji başlatarak, Sovyetler Birliği'ni çevreleyen ülkelere orta menzilli füzeler yerleştirip SSCB'ye karşı caydırıcılık sağlamayı hedeflemiştir. Türkiye'nin bu ülkelerden biri olması ise Türkiye'nin stratejik önemini gözler önüne sermiştir.

Türkiye, ABD ile yakın ilişki kurmak ve SSCB tehdidine karşı güçlü durmak istemesi sebebiyle ABD'nin bu stratejisine desteğini açıkça göstermiş, bunu takiben 25 Ekim 1959'da 'Jüpiter' adı verilen füzelerin İzmir-Çiğli'deki ABD üssüne konuşlandırılmasını öngören anlaşmayı imzalamış, bu durum SSCB'nin tepki ve baskısını beraberinde getirirse de 1962 yılında sistem kurulmuştur (Sönmezoğlu, 2006, s. 50-51). Soğuk Savaş döneminde ABD'nin dış politika stratejilerinde Türkiye kilit bir rol oynamıştır, özellikle SSCB'ye karşı geliştirilen stratejilerde Türkiye'nin önemi bu dönemdeki ikili ilişkilerde oldukça açıktır. Bu durumun getirisi ise Türkiye'nin Orta Doğu'da ABD'nin en fazla yardım yaptığı ülke olmasıdır. Truman Doktrini ve Marshall Planı'yla birlikte Türkiye'nin ABD'den aldığı ekonomik ve askerî yardımlar, NATO'ya üyelikle daha da artmıştır.

### 1960-1970 TÜRKİYE-ABD İLİŞKİLERİ

1960-1970 dönemi uluslararası ortamda bazı değişikliklerin meydana geldiği ve güç dengelerinin yeniden hareketlenmeye başladığı bir dönemdir. Bu dönemde, Amerika Birleşik Devletleri (ABD) ve Sovyet Sosyalist Cumhuriyetler Birliği (SSCB) liderliğindeki bloklaşma geçmişe göre değişen güç dengesi ekseninde bir yumuşama dönemine girmiş ve Soğuk Savaş'ın gerilimi nispeten biraz da olsa düşmüştür.

1950'lerin sonuna doğru, ABD'nin SSCB karşısındaki askerî ve teknolojik üstünlüğü SSCB'nin atakları karşısında kaybolmaya başlamış, ABD, Başkan Eisenhower'ın Kitlesele Karşılık Doktrini'ni, SSCB'nin ABD topraklarını vurabilecek silahlar elde etmesi dolayısıyla terk etmiştir. Bunun en önemli göstergesi 1962 yılında yaşanan Küba Krizi olmuştur. 1959 yılında Küba'da yaşanan komünist devrimin ardından bu ülkenin ABD ile ilişkileri bozulmuş ve Küba SSCB ile yakınlaşmaya başlamıştır. Bundan rahatsızlık duyan ABD, 1961 yılında Başkan J.F. Kennedy öncülüğünde Küba'ya başarısız bir askerî çıkarma yapmış (Domuzlar Körfezi Çıkarması) ve bu olaydan sonra ABD ile Küba arasındaki ilişkiler iyice gerilmiştir. Bu fırsattan yararlanan SSCB, Küba ile ilişkilerini daha da geliştirmiştir. (Bağcı, s. 159)





Bu doğrultuda Küba'ya füze rampası kurma girişiminde bulunan SSCB, ABD ile bir krizin eşliğine gelmiş, bu durum ise bir nükleer savaş tehdidini doğurmuştur. Bu tehditle birlikte SSCB ve ABD'nin karşılıklı olarak birbirlerini vurulabilecekleri anlaşılmış, ileride çıkabilecek bir savaş riskine karşı önlemler alma yoluna gidilmiş ve bunların sonucunda ise yeni bir uluslararası konjonktür ortaya çıkmıştır (Sander, 1987, s. 491). Nükleer güce sahip ülkelerin birbirini yok edecek güce sahip olmaları ile olası bir nükleer savaştan çekinerek nükleer silaha dayalı bir ilk saldırıdan kaçınmasını öngören Dehşet Dengesi (Ballance of Terror) politikaları, nükleer eşitliği savunarak uluslararası siyasete egemen olmaya başlamıştır (Sönmezoğlu, 2006, s. 60).

“Türkiye açısından dönemin dış politikasının genel hatlarını çizmek gerekirse bu dönemde Batı karşısında görece bir özerklik sağlanmış olsa bile, II. Dünya Savaşı sonrası çizilen dış politika çizgisi temelde bir değişime uğramamıştır” (Bağcı, s. 161). Bu duruma askeri ve ekonomik açıdan hala Batı'ya ihtiyaç duyulması ve kuzeyde Sovyetler Birliği tehdidinin sürüyor olması neden olmuştur. Fakat,

SSCB'nin Türkiye açısından bir tehdit olarak varlığını sürdürmesi yine de bu ülkeyle yakınlaşmaya engel olmamış, bu dönemde, Demokrat Parti (DP) dönemindeki kesin uzaklık politikası reel politik bağlamda değerlendirilip değiştirilmiş ve SSCB ile ilişkiler yakınlaştırılmaya başlanmıştır. Bu nokta, aslında bu dönemde Türk dış politikasının en önemli değişkenidir. Çünkü uzun yıllar süren SSCB'den uzak durma politikası bu dönemle birlikte kırılmaya başlamıştır. Bu hususta şunu söylemek mümkündür: Türkiye, 1960 sonrası dönemde dış politikada reel politikayı daha çok dikkate alıp tamamen ideolojik davranmak yerine çok yönlü bir politika izleyeceğinin sinyallerini vermiştir. Gerçi, bu durum yalnızca Türkiye için geçerli değildir. 1960 sonrası, her iki blokta yer alan ülkeler uluslararası konjonktüre bağlı olarak çok yönlü dış politikalar izlemeye başlamışlardır. (Bağcı, s. 161)

Kirisci'ye (1998) göre, Türkiye-ABD arasındaki ilişkiler, 1950'ler ve 1960'ların başları hariç, zorluklarla ve Türkiye'nin Amerikan dostluğuna ve niyetlerine duyduğu güvensizlikle gölgelenmiştir. Bu durum üç gelişmeden kaynaklanmıştır: Birincisi, 1962 Küba füze krizinin ardından ABD'nin Jüpiter füzelerini Türkiye'den çıkarma kararıdır. Türk elitinin bunun iki süper gücün arkasından yaptığı bir pazarlıktan kaynaklandığı yönündeki görüşü, ABD'nin Türkiye'nin güvenliğine olan bağlılığı konusunda şüpheleri artırmıştır. İkincisi, 1964 yılında, Türkiye Cumhuriyeti'nin kurucularından ve ulusal bir kahraman olan dönemin Başbakanı İsmet İnönü, Başkan Lyndon Johnson'dan aşağılayıcı sayılan bir mektup aldı. Mektup, oradaki Türk azınlığı tehlikeye atan Kıbrıs krizi sırasında, Türkiye'yi Kıbrıs'ta ABD silahlarını kullanmaması konusunda uyarılmış ve Kıbrıs'a müdahalesi Sovyet askeri tepkisine yol açarsa Türkiye'nin ABD desteğine güvenemeyeceği uyarısında bulunmuştur. Üçüncüsü ise, Türk kuvvetlerinin adanın üçte birini ele geçirdiği 1974 Kıbrıs krizinin ardından ABD, Türkiye'ye silah tedarik



yaptırımları uygulamıştır. Dönemsel çatışma alanları arasında ABD'nin ikili çevreleme politikasına ilişkin temel farklılıklar ve Kıbrıs'ın geleceği, Yunanistan-Türk ilişkileri, Türkiye'nin silah edinme programları ve Türkiye'nin insan hakları sorunlarına ilişkin sık sık yaşanan anlaşmazlıklar yer almaktadır (Kirisci, 1998).

### **1962 KÜBA KRİZİ VE ABD İLE İLİŞKİLER**

1962 Küba krizi, Türkiye ile Amerika Birleşik Devletleri arasında çıkan sorunlardan ilkidir. Kriz ortaya çıkmadan kısa bir süre önce ABD, İzmir Çiğli'ye yerleştirilen Jüpiter füzelerini kaldırmak istemiş; fakat Türkiye için bu füzelerin sembolik bir önem taşıması füzelerin kaldırılmasına engel olmuş ve füzeler İzmir Çiğli'de kalmıştır. Ama yine de SSCB'nin Türkiye'ye yerleştirilen Jüpiter füzelerinden rahatsızlık duyması dolayısıyla ABD'yi vurabileceği nokta olan Küba'yla anlaşarak bu ülkeye füze rampası kurması Küba Krizi'ne ortam hazırlayan bir unsur olmuştur. ABD ise buna karşılık, Küba'yı 24 Ekim 1962 tarihinde ablukaya alarak Küba'dan SSCB füzelerinin kaldırılmasını istemiş, Cumhurbaşkanı Cemal Gürsel 24 Ekim'de Türkiye'nin bu konuda ABD'ye tam destek verdiğini açıklamış ve böylece SSCB ile neredeyse nükleer bir çatışma yaratacak kriz tetiklenmiştir. SSCB ise, ancak Türkiye'ye yerleştirilen ABD füzelerinin Türkiye'den kaldırılması durumunda bu planından vazgeçeceğini belirtmiş ve ABD bunu kabul etmek durumunda kalarak Nisan 1963'te Jüpiter füzelerini sökmüştür (Erhan, 2004, s. 681-684; Sönmezoğlu, 2006, s. 63-66).

Küba krizi sırasında ortaya çıkan füzeler sorunu ortadan kalkmış olsa bile, ABD'nin bu konudaki tutumu Türkiye'nin dış politik tavrını önemli ölçüde değiştirip yönlendirmiştir. En önemlisi, ABD'nin İzmir Çiğli'deki füzeleri kaldırma kararı "Türkiye'de ABD'ye karşı bir güven kaybına yol açmış, bu durum da Türkiye'deki ABD karşıtlığını güçlendirmiştir" (Bağcı, s. 162). Bir diğer nokta ise, bu döneme kadar izlenen tek yönlü politikanın Türkiye için zararlı olduğu görülmüştür. Böylece Türkiye, dış politikası ile ilgili kararlarda öncelikle müttefiklerine danışma konusunda da değişikliğe giderek önce karar alıp sonra müttefiklerine danışma tutumunu benimsenmeye başlamıştır.

### **1964 KIBRIS KRİZİ VE ABD İLE İLİŞKİLER**

Kıbrıs'ta, Aralık 1963'ten itibaren 1960 Anayasası ile ilgili Rumlar tarafından yapılması istenilen değişikliklerin Türkler tarafından reddedilmesi sebebiyle Türkler'e yapılan saldırılar artmıştır. Bunun üzerine 25 Aralık 1963 tarihinde Cemal Gürsel, ABD Başkanı Lyndon Johnson'a bir mektup yollayarak bu mektupta adadaki saldırıların durdurulması için ABD'nin Rumlara baskı yapmasını istediğini belirtmiştir. Fakat her ne kadar Johnson sorunla ilgileniyormuş gibi görünse de Türkiye'nin yanında taraf olmayarak, ABD'deki Rum lobisini kaybetmemek için konuyla ciddi anlamda ilgilenmemiş ve yeterli ve gerekli tedbirleri almamıştır (Erhan, 2004, s. 685). ABD konu ile ilgili ciddi bir adım atmayınca, Türkiye kendisi bazı girişimlerde bulunmuş ve Kıbrıs Cumhurbaşkanı Makarios ile iletişime geçilmiştir; fakat



yine de Türklere yapılan saldırılar durmamış ve bu durum karşısında yine ABD herhangi bir girişimde bulunmamıştır.

Bunun üzerine Türkiye Büyük Millet Meclisi (TBMM), 16 Mart 1964'te İsmet İnönü Hükûmeti'ne adaya gerektiğinde askerî müdahalede bulunma yetkisi vermiştir. Bu yetkiden sonra İnönü Hükûmeti'nin adaya müdahalede bulunmaya hazırlandığı bir dönemde ABD Başkanı Johnson'ın İnönü'ye yolladığı ve Johnson Mektubu olarak bilinen mektup Türkiye-ABD ilişkilerini yeniden bir sorunla karşı karşıya getirmiştir. Başkan Johnson'un İnönü'ye yazdığı mektup, diplomatik bir dilden uzak ve yukarıdan emredici bir tarzda yazılmıştır. Bu durum Türk tarafının tepkisini çekmekle birlikte, asıl mektubun içeriği rahatsız edici olmuştur. İleride Kıbrıs sorununa ilişkin başlıkta daha ayrıntılı işleyeceğimiz bu mektup özetle Türkiye'nin Kıbrıs'a askerî bir müdahalede bulunmaması gerektiğine, bulunursa ABD'nin buna destek vermeyeceğine, bunun ötesinde Yunanistan'la girişilecek bir çatışmada NATO'nun tavrının bilinmeyeceğine, ayrıca böyle bir durumda SSCB'nin Türkiye'ye müdahalesi söz konusu olursa ABD'nin müdahalesinin söz konusu olmayabileceği gibi konulara değiniliyor, İnönü bir görüşme için Washington'a davet ediliyordu. (Bağcı, s.163)

Bu tutum Türkiye açısından oldukça şaşırtıcı ve beklenmedik olmuş, buna karşılık İnönü de bu durumun üzücü ve umulmadık bir gelişme olduğunu yazarak mektubunu ABD tarafına iletmiştir (Bölükbaşı, 2001, s. 686-689).

Johnson Mektubu'nun Türkiye-ABD ilişkileri üzerindeki etkisi uzun yıllar boyunca hissedilmiştir. İlk olarak, Türkiye, Kıbrıs'a uzunca bir süre askerî müdahale planlamamıştır. Ayrıca, ABD'ye olan güven Jüpiter füze krizinden sonra bir kez daha bu mektupla tekrar sarsılmıştır. Bunların sonucu olarak ise Türk kamuoyunda NATO'ya üyelik tartışma konusu haline gelmiştir. Dolayısıyla Johnson Mektubu'nun, Türkiye'nin çok yönlü bir dış politika izlemesinde etkisinin büyük olduğu görülmektedir çünkü bu mektuptan sonra Türkiye, SSCB başta olmak üzere diğer ülkelerle alternatif ilişkiler geliştirme yolunda ilerlemiştir. Ayrıca, ABD'nin dış politika ile ilgili aldığı her kararında hemen ve tam destek veren Türkiye, Johnson mektubuyla birlikte geri adım atmış ve bu olaylardan sonra dış politikada daha fazla kendi ülke çıkarlarına dayanan reel politikayı benimsemiştir.

## SONUÇ

Sonuç olarak, 1960-1970 yılları arasındaki Türkiye-ABD ilişkilerinde oldukça çalkantılı bir yol izlenmiştir. Bu dönem, "Türk-Amerikan münasebetlerinin inişler-çıkışlar, çalkantılar, sarsıntılar ve krizler dönemidir" (Armaoğlu, 2020, s. 617). 1960-1970 yılları arasında Türkiye-ABD ilişkileri ilk dönemlerde SSCB tehdidi gibi etkenlerden dolayı Türkiye'nin Batı'ya yönelimi ile umut vaat etse de, bu on yıllık süreç içinde dönemseller nedenlere bağlı olarak çalkantılı bir hal almış, iki ülke arasındaki ilişkiler düz bir zemine oturtulamamıştır. 1962 Küba



Krizi, ABD'nin İzmir Çiğli'ye yerleştirmiş olduğu Jüpiter füzelerini kaldırma kararı, Kıbrıs Sorunu, Johnson Mektubu gibi etkenlerle Türkiye-ABD ilişkilerinde Türkiye'nin ABD'ye güveni zedelenmiş, ABD'nin uluslararası politikada Türkiye'den vazgeçebileceği görülmüş, bunun sonucunda ise Türkiye, reel politikaya ek olarak, çok yönlü ve ulusal çıkarlarını gözetten bir siyaset biçimini benimseyip SSCB ve başka ülkeler ile yakınlaşma yoluna girmiştir. Bu da bu dönemde Türkiye-ABD ilişkilerinin aslında Türkiye-SSCB ve diğer ülkelerle ilişkilerini belirlemede ve ABD ile olan ilişkilerinin dışında alternatif geliştirmede önemli bir rol oynadığını göstermiştir.

#### KAYNAKÇA

- Armaoğlu, F. (2020). *20. Yüzyıl Siyasi Tarihi (1914-1995)*. İstanbul: Kronik Yayınları.
- Bağcı, H. (2018). Demokrat Parti Dönemi Türk Dış Politikası (1950-1960). *Türk Dış Politikası I* (Ed. Hüseyin Bağcı ve Kemal Yakut). Anadolu Üniversitesi, (ss. 130-158).
- Bağcı, H. (2018). 1960-1970 Dönemi Türk Dış Politikası. *Türk Dış Politikası I* (Ed. Hüseyin Bağcı ve Kemal Yakut). Anadolu Üniversitesi, (ss. 158-178)
- Bölükbaşı, S. (2001). *Barışçı Çözumsuzlük*. Ankara: İmge Kitabevi Yayıncılık.
- Erhan, Ç. (2004). ABD ve NATO'yla İlişkiler. *Türk Dış Politikası, Kurtuluş Savaşından Bugüne Olgular, Belgeler, Yorumlar*. İstanbul: İletişim Yayınları, (s. 681-715).
- Kirisci, K. (1998). Turkey and the United States: Ambivalent Allies. *Middle East Review of International Affairs*. (2/4).  
[https://ciaotest.cc.columbia.edu/olj/meria/meria98\\_kik01.html](https://ciaotest.cc.columbia.edu/olj/meria/meria98_kik01.html)
- Sander, O. (1987). *Olaylarla Türk Dış Politikası, Cilt I, Cilt II*. Ankara: Ankara Üniversitesi Siyasal Bilgiler Fakültesi Yayınları.
- Sönmezoğlu, F. (2006). *II. Dünya Savaşı'ndan Günümüze Türk Dış Politikası*. İstanbul: Der Yayınları.



## İSTANBUL'UN 1882'DEKİ TUNUSLU HACI ADAYI MİSAFİRİ: MUHAMMED es-SENÛSÎ

TUNUSIAN PILGRIM GUEST of ISTANBUL in 1882: MUHAMMAD AL-SENSUSI

**Doç. Dr. Zehra GÖZÜTOK TAMDOĞAN**

Tekirdağ Namık Kemal Üniversitesi

ORCID 0000-0001-9128-4026

### ÖZET

Hac yollarına ve yolculuklarına dair önemli kaynaklar arasında yer alan rihleler/seyahatnameler, hacı adaylarının farklı coğrafya, kültür ve topluluklarla karşılaşmalarının, onlara dair izlenimlerinin anlatıldığı eserlerdir. Tunus hac rihleleri arasında yer alan ve Muhammed es-Senûsî (ö. 1900)'ye ait *er-Rihletü'l-Hicaziyye* adlı eserinin Osmanlı topraklarının anlatıldığı 2. cildinin ele alınacağı bu çalışmada, yazarın İstanbul izlenimlerine odaklanılacaktır. XIX. Asrın sonlarını anlatan bu seyahatnamede yazar, Osmanlı'nın Tunus'u İspanyolların elinden kurtarması ve ve küffara karşı o toprakları muhafazası üzerinde durduktan sonra İstanbul'un kısa bir tarihini anlatmıştır. es-Senûsî'nin yolculuğu Tunus'tan Şaban/1299-Haziran/ Temmuz 1882 tarihinde başlamıştır ve aynı yılın Ramazan ayının 6. günü İstanbul'a girmişlerdir.

Yazar, İstanbul'un dünyanın en güzel manzarasına sahip olduğunu ifade ettikten sonra Eyüp el-Ensarî, Ayasofya Camii ve diğer birçok camii özellikle anlatmaktadır. Ayasofya Camii'nde yaşadığı "namazda ellerin salıverilmesi" ile ilgili hatırası, Ramazan'da Ayasofya'da yapılan tefsir, hadis dersleri ve vaazlar; Nuruosmaniye camii imamının hadis dersleri, Cuma hutbeleri, İstanbul camilerinde uygulanan güzel gelenekler, ilim hayatı, harika el yazmalarının bulunduğu 40'tan fazla kütüphane, medreseler, okutulan dersler, öğrenci sayıları yazarın üzerinde durduğu konulardır. Ayrıca halkın ve özellikle esnafın kıyafet çeşitliliği, kıyafetlerin aidiyeti de yine ayrıntılar arasında yer almaktadır. Şehrin kapıları, çarşıları, müzeleri, Beyoğlu ve orada meskûn Fransızlar, halkın davranış şekilleri, kadınların durumu, mezhepler, bazı siyasî durumlar, Sultan Abdülhamid Han ve sultanın casusları, Padişahın, kendisinden Arapça bir gazete çıkarmasını istemesi, birçok olay veya kişiyle ilgili kasideler ve özellikle de Sultan Abdülhamid'e yazdığı kasideler, bazı mektuplar yine bu çalışmanın konusu olacaktır. Hakkında herhangi bir çalışmanın olmaması bizi teşvik sebebidir.

**Anahtar Kelimeler:** İslâm Tarihi, Mağrib, Tunus, İstanbul, Hac, Muhammed es-Senûsî, II. Abdülhamid



## ABSTRACT

Among the important sources on the pilgrimage routes and journeys, travelogues are works in which the pilgrims' encounters with different geographies, cultures and communities and their impressions of them are described. In this study, we will focus on the second volume of Muhammed el-Senūsī's (d. 1900) work called al-Rihle al-Hijaziyya, one of the Tunisian pilgrimage travelogues in which the Ottoman lands are described, and the author's impressions of Istanbul will be explained. In this travelogue describing the end of the 20. century, the author, after dwelling on the Ottoman liberation of Tunisia from the Spaniards and the protection of those lands against the infidels, gives a brief history of Istanbul. Al-Senūsī's journey started from Tunisia in Shaban 1299/June-July 1882 and they entered Istanbul on the 6th day of Ramadan of the same year.

After stating that Istanbul has the most beautiful view in the world, the author describes Eyup al-Ansarī, Hagia Sophia Mosque and many other mosques. His recollection of the "release of hands in prayer" he experienced in Hagia Sophia Mosque, the tafsir, hadith lessons and sermons held in Hagia Sophia during Ramadan, the hadith lessons of the imam of Nuruosmaniye Mosque, Friday sermons, the beautiful traditions applied in Istanbul mosques, the life of science, more than 40 libraries with wonderful manuscripts, madrasas, the courses taught, the number of students are the subjects the author emphasizes. In addition, the diversity of the clothes of the people and especially the tradesmen and the belonging of the clothes are also among the details. The city's gates, bazaars, museums, Beyoglu and the French inhabitants there, the behaviour of the people, the situation of women, sects, some political situations, Sultan Abdul Hamid Khan and the Sultan's request for him to publish an Arabic newspaper, the ode about many events or people and especially the ode he wrote to Sultan Abdul Hamid, some letters will be the subject of this study. We are encouraged by the fact that there is no study on him.

**Keywords:** Islamic History, Maghrib, Tunisia, Istanbul, Hajj, Muhammad al-Senusi, Abdul Hamid II.



## «ALLATRA» DİNİ HAREKETİ

RELIGIOUS MOVEMENT «ALLATRA»

«АЛЛАТРА» ДІНІ ҚОЗҒАЛЫСЫ

**Dr. Öğr. Üyesi Bayurzhan SAİFUNOV**

Hoca Ahmet Yesevî Uluslararası Türk-Kazak Üniversitesi, İlahiyat Fakültesi, Türkistan/  
Kazakhstan

ORCID ID: <https://orcid.org/0000-0001-8707-7075>. +7707-276-01-76.

**Ayaulym SERİK**

Yüksek Lisans öğrencisi, Hoca Ahmet Yesevî Uluslararası Türk-Kazak Üniversitesi, İlahiyat  
Fakültesi, Türkistan/ Kazakhstan

### ÖZET

Makale "AllatRa" dini hareketine genel bir bakış sunuyor. Uluslararası Toplumsal hareketi "AllatRa", merkezi Ukrayna'da bulunan ve aynı zamanda Rusya'da, birçok Avrupa ülkesinde (çoğunlukla Slav) ve ABD'de faaliyet gösteren yeni bir dini harekettir. Kendilerini siyasetin ve dinin dışında faaliyet gösteren bir sosyal birlik olarak konumlandırıyorlar. Özellikle "AllatRa" dini hareketinin oluşum tarihi, hareketin oluşumunu etkileyen siyasi ve sosyal faktörler, doktrini ve konuları ele alınacaktır. Dinler tarihinde 21. yüzyıl, yeni dini örgüt ve hareketlerin ortaya çıktığı dönem olarak nitelendirilmektedir. "AllatRa" dini hareketinin de bu olgunun bir özelliği olduğu düşünülmektedir. "AllatRa" organizasyonu 2010 yıldan itibaren sistemleşmeye başlamıştır. Günümüzde Avrupa ve ABD'nin yanı sıra BDT ülkelerinde de hızla yayılan ve destekçileri her geçen gün artan dini bir hareket haline gelmiştir. Araştırmacılar Allatra'yı Ukrayna'da yaratılan "felsefi ve kültürel bir hareket" olarak değerlendiriyor. Allatra dini hareketinin üyelerine göre bu örgüt, uyumlu bir toplum yaratmak ve dünyadaki tüm krizlerin üstesinden gelmek için manevi bilgiyi geliştirmeyi ve insanlığa yaymayı amaçlıyor. Allatra hareketinin takipçileri, yollarının ana ilkelerinin "hayata saygı, insan sevgisi, kişinin eylemlerinden insani sorumluluk, doğanın ve tüm yaşamın korunması ve muhafaza edilmesi" olduğunu açıklıyor. Hareket aynı zamanda farklı kültür ve dinlerin manevi bilgileri, meditasyon ve diğer manevi uygulamalarla ilgili çalışmalara da aktif olarak katılmaktadır. Allatra üyeleri, "insanları daha uyumlu ve adil bir dünya yaratma ortak hedefi doğrultusunda bir araya gelmeye ve işbirliği yapmaya davet ettiklerine" inanıyor. Makalede betimsel yöntem ve karşılaştırmalı analiz yöntemi kullanılmıştır.

**Anahtar Kelimeler:** AllatRa, İmam Mehdi, yeni dini hareket, siyaset, mezhep.

### ABSTRACT

The article provides an overview of the AllatRa religious movement. The International Social movement "AllatRa" is a new religious movement based in Ukraine, but also active in Russia, many European countries (mostly Slavic) and the USA. They position themselves as a social union operating outside politics and religion. In particular, the history of the formation of the "AllatRa" religious movement, the political and social factors affecting the formation of the



movement, its doctrine and positions will be discussed. In the history of religions, the 21st century is described as the period in which new religious organizations and movements emerged. The "AllatRa" religious movement is also thought to be a feature of this phenomenon. "AllatRa" organization has started to be systematized since 2010. Today, it has become a religious movement that is rapidly spreading in CIS countries as well as Europe and the USA, and whose supporters are increasing day by day. Researchers consider Allatra a "philosophical and cultural movement" created in Ukraine. According to members of the Allatra religious movement, this organization aims to develop and spread spiritual knowledge to humanity in order to create a harmonious society and overcome all crises in the world. Followers of the Allatra movement explain that the main principles of their path are "respect for life, love of humanity, human responsibility for one's actions, protection and preservation of nature and all life." The movement also actively participates in the study of spiritual knowledge of different cultures and religions, meditation and other spiritual practices. Allatra members believe they "invite people to come together and cooperate towards the common goal of creating a more harmonious and just world." Descriptive method and comparative analysis method were used in the article.

**Keywords:** AllatRa, new religious movement, Imam Mahdi, politics, sect.

### Түйіндеме

Мақалада «Аллатра» діни қозғалысына шолу жасалады. «АллатРа» Халықаралық қоғамдық қозғалысы – бұл Украинада орналасқан, бірақ Ресейде, Еуропаның көптеген елдерінде (негізінен славян) және АҚШ-та белсенді танылған жаңа діни қозғалыс.<sup>1</sup> Олар өздерін саясат пен діннен тыс әрекет ететін қоғамдық бірлестік ретінде көрсетеді.<sup>2</sup> Осы мақалада «АллатРа» діни қозғалысының қалыптасу тарихы, қозғалыстың қалыптасуына әсер ететін саяси-әлеуметтік факторлар, оның доктринасы мен ұстанымдары сөз болады. Діндер тарихында 21 ғасыр жаңа діни ұйымдар мен қозғалыстардың пайда болған кезеңі ретінде сипатталады. «АллатРа» діни ағымы да осы құбылыстың ерекшелігі деп есептеледі. «Аллатра» ұйымы 2010 жылдан бастап жүйелене бастаған. Бүгінде бұл ТМД елдерімен қатар Еуропа мен АҚШ-та қарқынды таралып, қолдаушылары күннен-күнге артып келе жатқан діни ағымға айналды. Зерттеушілер Аллатраны Украинада құрылған «философиялық және мәдени қозғалыс» деп санайды. «Аллатра» діни қозғалысы мүшелерінің айтуынша, бұл ұйым үйлесімді қоғам құру және әлемдегі барлық дағдарыстарды еңсеру үшін адамзатқа рухани білімді дамытып, таратуды көздейді. «Аллатра» қозғалысының ізбасарлары өз жолының негізгі қағидалары «өмірді құрметтеу, адамзатты сүю, адамның өз іс-әрекетіне жауапкершілігі, табиғатты және бүкіл тіршілікті қорғау және сақтау» деп түсіндіреді. Қозғалыс сонымен қатар әртүрлі мәдениеттер мен діндердің рухани білімін, медитация және басқа да рухани тәжірибелерді зерттеуге белсенді қатысады. «АллатРа» мүшелері адамдарды үйлесімді және әділетті қоғам құрудың ортақ мақсатына жету бірігуге және ынтымақтастыққа шақырады. Мақалада дескриптив әдісі және салыстырмалы талдау әдісі қолданылды.

---

<sup>1</sup> Попова И.Н. "Справочник всех религиозных течений и объединений в России" (аналогичный его ранее изданному справочнику о всех религиях Индонезии, см.: Попов, Igor. *Buku rujukan semua aliran dan perkumpulan agama di Indonesia*. Singaraja: Indra Jaya, 2017)

<sup>2</sup> Грива О. А. *О незаконной миссионерской деятельности новых религиозных движений (на примере МОД «АллатРа»)*// Религия. Общество. Человек: сб. матер. науч. чтений 17-18.10.2019, Симферополь: ИТ «Ариал», 2019. - с.36-47. - 157 с.





**Кілт сөздер:** АллатРа, жаңа діни қозғалыс, Имам Махди, саясат, секта.

## Кіріспе

"АллатРа" Халықаралық қоғамдық қозғалысы ("АллатРа" ХҚК) - жаңа діни қозғалыс. Украинада құрылған. Сонымен қатар, Ресейде, Еуропа елдерінде (негізінен славян елдерінде) және АҚШ-та әрекет етеді және де ол елдерде жылдам болмаса да уақыт өткен сайын жақтастары көбейіп келеді. Бұл ұйым өкілдері өздерін саясат пен діннен тысқары қоғамдық одақ ретінде көрсеткісі келеді. Дегенмен аталған ұйымға жүргізілген әр қырлы сараптамалық талдаулар теріс нәтижені көрсеткен. Ашық болмаса да белгілі бір саяси мүддеге жұмыс жасайтындары зерттеушілер тарапынан нақтыланған. «АллатРа» ұйымы христиандық ортада, христиан діні өкілдері тарапынан құрылған болса да танымы мен доктринасында түрлі діндердегі ұстанымдар байқалады. Дегенмен бұл ұйымды түрлі діни ұстанымды синтездеуші секта ретінде қарастыра алмаймыз, себебі өз көзқарастарына сәйкес сенімдік ұстанымдарын негізінен ақырзаманда шығатын құтқарушы (Иса Мәсіх-Имам Махди) түсінігі негізінде ғана қарастырады. Олардың бұл сенімі де негізінен белгілі бір саяси топтардың пропагандасы ретінде қарастырылып келеді.

## 1. Дінтанулық сипаты

«АллатРа» Халықаралық қоғамдық қозғалысының өкілдері өздерін саясат пен діннен тысқары қоғамдық одақ ретінде көрсеткенімен, дінтанушылар бұл ұйымды (М. Р. Бигнова, П. Н. Костылев, В. А. Мартинович) "АллатРа" қозғалысын жаңа діни қозғалыс белгілері бар саналатын «Жаңашыл ойлау» және «Нью-эйдж» топтары ретінде қарастырады. Қозғалыстың оқу элементтерінде таяу шығыс мифологиясы, зороастризм, гностицизм, теософия және агни-йоганың ықпалы бар екендігі байқалады. И. Н. Попов атап өткендей, мәтіндерде кітаптар Анастасия Новыхтың авторлығымен жазылған кітаптардың мәтіндерінде "Юсмалостың ақ бауырластығы" идеяларының әсері анық байқалады. Сонымен қатар Валентина Новикова, АллатРа сенімінің анастасийлік қозғалыс ("Звеньящие кедры России") өкілдері ұстанымымен өте қатты құсастығына тоқталып өтеді. А.П. Горюнов бұл қозғалыстың доктринасын халықаралық террорлық ұйымдардың идеологиясына ұқсастығын атап өтеді, ал ақпараттық стратегиясын БАҚ-тың назардан тыс қалдыруы ретінде анықтайды [1].

АллатРа ұйымының тарихы прозалық түрде басталды - шын мәнінде прозадан, дәлірек айтсақ, осы уақытқа дейін белгісіз жазушы Анастасия Новыхтың бірінші кітабынан (тұлғасы туралы, айтпақшы, бүгінгі күнге дейін ешкім нақты ештеңе білмейді). Алғашқы жеті кітап оны ми ісігінен сауықтырған вертеболог, жекпе-жек өнерінің шебері, зиялы және философ Сенсейдің тарихы туралы баяндайды. Кейінгі кітаптарда, болжамдар мен пайғамбарлықтарда көптеген тарихи оқиғалардың, рухани тәжірибелер мен медитациялардың жаңа интерпретациясы және «алғашқы АллатРа физикасы» пайда болады. Олар көптеген жалған ғылыми теориялар мен терминдермен толтырылған. Автордың энциклопедиялық білімнен бөлек, адамгершілікті, адалдықты, жасампаздық пен мейірімділікті адамгершілікпен өзін-өзі жетілдіруге бағыттайтын өзіндік әдістерге ие сынды көрінеді. Сонымен қатар бұл ағымды ұстанушылар физикадан бөлек, тарих, география, математиканы да меңгерген сияқты сипатталады. Содан кейін ұйым мүшелерінің нақты қандай міндеттері бар екендігі түсіндіріледі:



- әлеуметтік, мәдени, қоғамдық маңызы бар жасампаз істерді, жобалар мен бағдарламаларды іске асырады;

- Достық, жасампаздық, ізгілік және өзара көмек негізінде бүкіл әлемдегі әлеуметтік белсенді азаматтардың әлемдік бірлестігінің тәсілдері мен мүмкіндіктері туралы қоғамның білім деңгейі мен хабардарлығын арттырады;

- бір-бірімен, сондай-ақ түрлі әлеуметтік қозғалыстармен, халықаралық, мемлекеттік, үкіметаралық, қоғамдық, және діни ұйымдармен, қорлармен, кәсіби қауымдастықтармен, кәсіподақтармен, академиялық топтармен, бұқаралық ақпарат құралдарымен жедел ынтымақтасады. Осындай өзіндік критерилері бар.

## 2. Ислам парадигмасындағы "АллатРа" радикализмі

Анастасия Новыхтың айтуынша, «мұсылман», Ислам дініндегі әрбір дүниеге келген мұсылман Аллаға емес, Пайғамбарға бағынушы дегенді білдіреді. «Мұсылман» сөзі «мүмін» деген ұғымға қатысты кейінірек қолданыла бастады [2, б. 389] дейді.

АллатРа идеологтарының бұл көзқарастарының Құран Кәрімнің рухымен қарама-қайшы екенін көруге болады (қараңыз: Құран 3 сүре 64 аят ). Ортағасырлық араб мәтіндерін зерттеушілердің пікірінше, «мүмін» (мұсылман) сөзі мынадай екі мағынаға сәйкес келеді: 1) шын ықыласпен Аллаға құлшылық ету және 2) Алла Тағаланың әміріне бойұсыну [3, б. 112].

Анастасия Новых, ғайыптанушы Ригден Джаппо сияқты адам жанының қайта туылуы (танасух) жайында адамдардың жасаған күнәлары үшін, қайта туылады [4, б. 692–694]. Дегенмен, жазалаумен бірге Қиямет күні АллатРа ілімі жанды таза күйге дейін тазарту мүмкіндігін қарастырады. Тозақтың жердегі барлық шеңберлерінен реинкарнациядан өту нәтижесінде күнәлардан толық тазаруға болады дейді [5, б. 335]. Кей жағдайларда "АллатРа" танымының Құран аяттарын да елемейтіндігін көруге болады.

Қиямет күні адам жанының қайтыс болғаннан кейінгі тағдыры туралы Ислам теологиясында жанның реинкарнациясы туралы ілімдерде ондай түсінік жоқтығын дәлелдейтін түсініктемелер береді. Құран жанның реинкарнациялану мүмкіндігін жоққа шығарады, адам жанының қиямет күні қайта тірілуі, күнәлары үшін жаза алатыны, жақсылығы үшін сыйлыққа кенелетіні туралы айтады.

АллатРа ілімінің Ислам теологиясының негізгі қаидаларына қайшылығын келесі фактілер де айғақтайды. 2019 жылдың 30 шілдесінде AllatRa-TV сайтында және YouTube-тегі AllatRaTV арнасында кейбір мұсылмандар сенетін «Имам Махдидің келуі туралы» негізгі хадистерді қабылдамайды, Имам Махдидің Пайғамбардың ұрпағынан шығатынын қабылдамайды. Исламға қайшы келетін тағы бір түсініктері «Алланың Әлемді Жарату» мәселесі. Ұлы Ислам ғұламасы Имам Әбу Жафар әт-Тахауи (843–933): «Алла жаратылғаннан кейін «Жаратушы» деген атқа ие болған жоқ - Ол әрқашан Жаратушы болды. Ол жасау әрекетінен кейін «Жаратушы» деген атқа ие болған жоқ, Ол әрқашан Жаратушы болды; Ол барлық нәрсені Өзінің [Мәңгілік] Білімімен жаратты» дейді [6, б. 11, 12]. Тек біз атап өткен қайшылықтар ғана емес, сонымен қатар бұданда бөлек ислам дініне көптеген қайшы пікірлер айтылып жатыр. Аталмыш ұйымның әлеуметтік желілерінде, Youtube желісінде, Аллатра ТВ сайттарында жарияланған видеороликтерден Ислам құндылықтарына қарама-қайшы пікірлерді көптеп кездестіруге болады.



### 3. Баспа қызметі

"АллатРа" қозғалысының негізгі шығармашылық еңбектерінің тізіміне (2016 жылғы дерек бойынша) «АллатРа», «Исконная физика АллатРа», «Сэнсэй» Исконный Шамбалы», «Птицы и камень. Исконный Шамбалы», «Эзocosмос. Исконный Шамбалы», «Перекрестье. Исконный Шамбалы», «Духовные практики и медитации», «Предсказания будущего и правда о прошлом и настоящем» атты түрлі бағыттағы еңбектер енеді.

Аталмыш қозғалыстың идеологиясының негізгі қайнар көзі – АллатРа кітабы болып саналады. Бұл автордың (Анастасия) Ригден есімді сұхбаттасушымен диалогының жазбасы. Кітап мәтіні Құдай, адам және дүние құрылымы туралы мистикалық және табиғаттан тыс бейнелер мен аяндарға толы. "Аллатра" кітабы Аллатра қозғалысы танымының негізі. Оны 1998 жылы Украин авторы Анатолий Новых жазған және әлемнің көптеген тілдеріне аударылған. Кітап – әртүрлі халықтардың руханилығы, философиясы, ғылымы мен мәдениеті туралы білімнің бірегей синтезі. Бұл кітапта қозғалыс лидерлерінің көзқарастары бойынша адамның табиғаты, оның жердегі миссиясы және үйлесімділік пен бақытқа қалай жетуге болатындығы туралы терең шындықтар бар.

"Аллатра" кітабында адамдар арасындағы бірлік пен ынтымақтастықтың маңыздылығы, ұлттық және діни айырмашылықтарды жеңу қажеттілігі туралы айтылады. Ол рухани құндылықтар мен адамның қадір-қасиетін құрметтеуге негізделген біртұтас әлемдік қауымдастық құруға шақырады. "Аллатра" кітабы әлемнің көптеген елдерінде нағыз бестселлерге айналуда, тіпті көптеген рухани көшбасшылар мен ғалымдардың құрметіне ие болуда. Ол көптеген адамдарға өмірдегі рухани даму мен үйлесімділікке жол табуға көмектесуде.

"АллатРа" кітабы эксклюзивті мәліметтерді ашады. Мысалы, адамның жеке басы және оның жаны туралы; суб-тұлғалар және олармен байланысты құбылыстар туралы; адамның қос табиғаты туралы: оның рухани және жануарлық принциптерінің процестері туралы; дүниетанымның маңыздылығы, оның таңдауға әсері туралы; адамның өлімнен кейінгі тағдырын алдын-ала анықтайтын тұлғалар. АллатРа кітабында әлемде алғаш рет физикалық дене қызметі тоқтағаннан (адам қайтыс болғаннан соң) кейін өтпелі күйдегі адамның жанының ерекше фотосуреттері келтірілген. Көрінбейтін әлемдегі адамның көпөлшемді дизайны, адамның басқа өлшемдермен байланысы, оның үшінші өлшемнен басқа ерекше мүмкіндіктері туралы жазылады. Неліктен адамға артық ми қажет, көп деңгейлі сананың болуы, сананың өзгерген күйі дегеніміз не, оған кезең-кезеңімен өту қалай жүреді – деген сияқты сан қилы сұрақтарға жауап береді. Кітапта ежелгі рухани тәжірибелер өз бетімен жұмыс істеуге және жанмен бірігуге, алтыншы сезімді дамытуға және рухани әлеммен байланыста болуға арналған. Онда табиғаттан тыс қабілеттердің табиғаты (көріпкелдік, басқалардың ойларын оқу, көрегендік) және оның адам үшін көрінуінің екі жақтылығы; көрінбейтін әлемнің процестерін түсінуде өз бетімен жұмыс істеудің маңыздылығы туралы айтылады. Сондай-ақ бақылаушы ретінде жеке тұлғалар және олармен байланысты құбылыстар туралы; адамның қос табиғаты туралы: оның рухани және жануарлық принциптерінің процестері туралы; үстем дүниетанымның маңыздылығы, оның өлімнен кейінгі тағдырын алдын-ала анықтайтын жеке тұлғаны таңдауға әсері туралы өзіндік қызықты мәліметтер беріледі.



"АллатРа" ұйымының көптеген сайттар, бағдарламалар мен басылымдар түріндегі ауқымды үгіт-насихат қызметіне қарап қозғалыстың жұмыс жасау жүйесі өте жақсы әрі жүйелі ұйымдастырылғанын көруге болады. Бұл қозғалыстың әдептерінің ақыл-ойға әсер ету әдісінің өте ерекше екенін көрсетеді. Кәдімгі көркем шығарманың кейпінде оккультизм құндылықтары адам санасына жаңа дүниетаным ретінде енгізіледі.

«Сэнсэй» сериясындағы төрт кітап Анастасияны қатерлі ісік ауруынан емдеген невропатолог туралы айтады. Кітаптарда ол «Сэнсэй» деп аталады және философ және жауынгерлік өнердің шебері ретінде сипатталады.

«Эзоосмос» және «Птицы и камень» және басқа да кітаптарда көптеген жалған ғылыми теориялар, тарихи оқиғалардың интерпретациясы мен пайғамбарлықтар жөнінде өзіндік теориялар бар.

Костянтин Москалюктің «Аллатра – ескі оккульттік үлгі бойынша соңғы эзотерикалық қозғалыс» атты мақаласында «Анастасия Новых» бүркеншік атына жасырынған Данилов Игорь Михайловичтің авторлығының жанама түрде оның кітаптарында сәйкес келетін сөйлеу ерекшеліктерімен көрсетілгенін атап өтеді. Сонымен қатар, «ЛитМир» сайтында Игорь Михайлович Данилов «Кәсіби пациентке арналған остеохондроз» кітабының авторы және 30-ға жуық кітаптың аудармашысы ретінде, соның ішінде детектив, фэнтези, эпикалық фантастика және шытырман оқиғалы жанрдағы (мысалы «Реликвии тамплиеров» және «Седьмое таинство») еңбектерінің екендігі жазылады. АллатРа кітаптарының авторы үшін бұл қолайлы фон болып табылатынын сөз етеді. АллатРа шығармасының тағы бір ықтимал авторы - Марна Цвигун (Мария Деви Христос) екендігін ишара етеді[7].

АллатРа.TV сайтында мұсылмандар үшін «Ислам – махаббат діні» деген, ал христиан қауымы үшін «Христиандық – махаббат діні» атты христиандарға бағытталған сонымен қатар, түрлі бағыттағы псевдоғылыми, оккульттік және жарнамалық, жалпы барлығы 48 ақпараттық бейнероликтер жарияланған. Зерттеу кезінде ақпараттық жобалардың 20 бейнероликтен тұратын «Христиандық – махаббат діні» жобасының алғашқы жарияланымы 2020 жылдың 14 наурызында басталған болса, «Ислам – махаббат діні» жобасы 30 желтоқсанда әлеуметке жол тартқан. 2018 жылдан бері АллатРа телеарнасы бас-аяғы 77 видеоны қамтитын әр түрлі тақырыптарда бейне роликтер түсірген. AllatRa TV – рухани даму, мәдениет, ғылым, қоғам және экология саласындағы идеялар мен білім алмасу алаңын қамтамасыз етуге бағытталған «AllatRa» қозғалысының бөлігі болып табылатын медиа алаң. Ол әртүрлі мәдениеттер мен діндердің өкілдерін шабыттандыруға және біріктіруге тырысатын сұхбаттар, пікірталастар, репортаждар, фильмдер және басқа да мазмұнды әртүрлі бейне материалдардан тұрады. «Аллатра» сонымен қатар әртүрлі елдердің адамдары қатысатын халықаралық қоғамдық-саяси қозғалыстың атауы. Ұйымның өз үгіттеушілерінің сөзінен түсінетініміз АллатРа қозғалысы ізгілік, адамгершілік, руханилық және жақынға деген сүйіспеншілік принциптерін насихаттауға арналған. Ұйым мәдени, экологиялық, әлеуметтік және рухани мәселелер саласында да әрекет етеді және Аллатраның ортақ құндылықтарын бөлісетін адамдар арасындағы үйлесімді өзара әрекеттесу үшін жағдай жасауға бағытталған.



#### 4. Доктринасы

Будда, Иса Пайғамбар, Мұхаммед Пайғамбар және православиелік әулие Агапит Печерский бодхисаттвалары пайғамбар, әулие, қасиетті тұлғалар ретінде құрметтеледі. Игорь Михайлович Агапит Печерскийдің «реинкарнациясы» болып саналады, сонымен қатар ол «Киелі Рухтың жұбатушысы», «Машиах», Ригден Джапо, Калки, Майтрея және сондай-ақ Имам Махди болып саналады. Бас әріптерінің инициалы «И. М.» ретінде болуын сәйкестік емес дәлел ретінде қарастырады. Олардың танымында дуалистік көзқарасты анық байқауға болады. Абсолютті Жаратушы «АллатРа» әйелдік бастау (Аллат) және еркектік-әкелік (Ра)-дан құралған. Сипатталған ілімге сәйкес, адамдарда рухани принцип бар. Рухани түсінікте барлық адамдар біртұтас. Адамзатты халықтарға, мемлекеттерге және діндерге бөлетін материалдық ақыл. Дүниенің біртұтас рухани негізде бірігуі славян халықтарының бірігуінен басталатыны және болашақта жақсылық пен зұлымдықтың шайқасында Ресей басшысы маңызды рөл атқаратыны баса айтылады. Негізгі діни тәжірибе ретінде ізбасарларға таңертеңгі және кешкі медитация ұсынылады [8].

#### 5. Рәмізі

Қозғалыстың рәмізі ретінде «АллатРа белгісі» қолданылады — оның астында бос жарты ай бейнеленген, «мүйіздері» жоғары қаратылған бос шеңбер. Шеңбер жанның символы - Құдай әлемінен рухани болмыстың көрінісі ретінде ұсынылған. Жарты ай, тірі кезінде рухани азат болған адамды бейнелейді. Егер белгі бір нәрсемен толықтырылса, онда ол жұмысшы болып саналмайды және тек ақпараттық таңбаға айналады, бұл белгінің шындықпен «кванттық әрекеттесуінің» бұзылуы туралы жалған ғылыми пайымдаулармен түсіндіріледі [9].

#### 6. Қазақстандағы көрінісі

Аллатра қозғалысы Қазақстанда белсенді дамып келеді. 2015 жылы ел аумағындағы қозғалыс қызметін үйлестірумен және ұйымдастырумен айналысатын Аллатраның ұлттық үйлестіру орталығы құрылды. Қазақстанда руханиятты дамытуға және Аллатра мұраттарын насихаттауға арналған түрлі іс-шаралар өткізіледі. Бұл семинарлар, конференциялар, кездесулер, пікірталастар және басқа да іс-шаралар. Қазақстандағы қозғалыстың негізгі міндеттерінің бірі ұлтына, дініне және әлеуметтік мәртебесіне қарамастан адамдар арасындағы АллатРа лидерлерінің негізгі көзқарастары аясында бірлік пен ынтымақтастық идеясын насихаттау. Сондай-ақ, Қазақстандық Аллатрашылар жастарды тәрбиелеумен, әртүрлі халықтардың руханилығы мен мәдениеті туралы білімді таратумен белсенді айналысуға ұмтылыста. Жалпы, Қазақстандағы Аллатра қозғалысы қоғамдағы руханият пен үйлесімділіктің дамуына ықпал ететін маңызды факторлардың бірі болуға күш салуда. Бүгінгі таңда аталған ұйымның мүшелігінде әлеуметтік қабаттардың әр қабатынан өкілдер кездеседі. Тіпті сәтті дамушы кәсіпкерлер мен бұрынғы жылдары елімізге танымал болған кейбір дінтанушы зерттеушілерді де АллатРа ұйымының мүшелігінен кездестіруге болады.

#### Қорытынды

Қорытындылай келгенде «АллатРа» қозғалысы өздерін қоғамдық бірлестік ретінде көрсеткенімен, дінтанулық және социологиялық сараптамаларды негізге алатын болсақ, діни бірлестіктің белгілері анық көрінеді. Кей кезеңдерде әлеуметтік бағдарламаларға белсене қатысқынын да атап өттік. Өздеріне жақтастар тартып, қозғалыс мүшелерін арттыру мақсатында интернет платформаларын кеңінен



пайдаланатынын көруге болады. Жүргізіп отырған пропагандасы сәтті жүзеге асуы үшін лидерлері тарапынан жазылған кітаптарын интернет желісінде қолжетімді әрі тегін таратау тенденциясына да ие. Миссионерлік қызметтерінде негізінен псевдоғылыми тұжырымдарға негізделген методтарды қолданады. Бірақ аталған қозғалыстың діни әдебиеттерінде ашықтан-ашық зорлық-зомбылыққа үгіттейтін тұстары кездеспейді. Сондықтан «АллатРа» қозғалысына экстремистік-террористік ұйым ретінде баға беру қиын. Соған қарамастан бұл қозғалыстың саясаттың қолшоқпары ретінде (әсіресе қазіргі кездегі геосаяси жағдайларға байланысты) кез-келген жағдайда қауіпті күшке айналып кету потенциалына ие екендігін ескеру керектігін ұғындырады. Діни әдебиеттерінде Құран-Кәрім, Алла, Мұхаммед және негізінен Имам Махди сеніміне қатысты ұстанымдарға, сонымен қатар өзге де діндердегі ұстаным мен принциптерге орын берілуі бұл ұйымның глобалдық қызметті көздейтінін айғақтайды.

### Пайдаланған әдебиеттер:

1. Лункин Р. Н. Распад СССР. Как это отразилось на церкви и жизни верующих. URL: <http://www.invictory.com/columns/1032/> (дата обращения: 13.05.2020).
2. Новых А. Сэнсэй. Исконный Шамбалы. М., 2019.
3. Хрестоматия по исламу. Введение и примечания / перевод с арабского. М., 1994.
4. Новых А. АллатРа. М., 2019.
5. Новых А. Сэнсэй. Исконный Шамбалы. М., 2012.
6. Акыда ат-Тахавийя. Разъяснение вероубеждения Ахлю-с-Сунна валь Джама`а. URL: [http://as-sunna.ru/books/akida\\_tahavi.pdf](http://as-sunna.ru/books/akida_tahavi.pdf) (дата обращения: 21.11.2019).
7. Новых А. Сэнсэй. Исконный Шамбалы. М., 2019.
8. Мартинович В. А. Сектантство: возникновение и миграция. М., 2018.
9. Вагабов М. В. Расколы в исламе: причины и социальные последствия // Исламоведение. 2010.
10. Попова И.Н. "Справочник всех религиозных течений и объединений в России" (аналогичный его ранее изданному справочнику о всех религиях Индонезии, см.: Popov, Igor. *Buku rujukan semua aliran dan perkumpulan agama di Indonesia*. Singaraja: Indra Jaya, 2017)
11. Грива О. А. *О незаконной миссионерской деятельности новых религиозных движений (на примере МОД «АллатРа»)*// Религия.Общество.Человек: сб. матер. науч. чтений 17-18.10.2019, Симферополь: ИТ «Ариал», 2019. - с.36-47. - 157 с.

25.01.2024

REF: Akademik Teşvik

İlgili makama;

ATLAS 11. ULUSLARARASI İLERİ BİLİMSEL ÇALIŞMALAR VE DİSİPLİNLERARASI ARAŞTIRMALAR KONGRESİ, 16-18 Ocak 2024 tarihleri arasında Marakeş, FAS'ta 18 Türkiye, Azerbaycan, Algeria, Albania, Pakistan, Serbia, Morocco, Indonesia, Nigeria, United Arab Emirates, Benin, Ethiopia, India, Romania, Moldova, West Africa, Kazakhstan, Libya) farklı ülkenin (Türkiye 26 bildiri- Diğer ülkeler 38 bildiri) akademisyen/araştırmacılarının katılımıyla gerçekleşmiştir.

Kongre 16 Ocak 2020 Akademik Teşvik Ödeneği Yönetmeliğine getirilen "Tebliğlerin sunulduğu yurt içinde veya yurt dışındaki etkinliğin uluslararası olarak nitelendirilebilmesi için Türkiye dışında en az beş farklı ülkeden sözlü tebliğ sunan konuşmacının katılım sağlaması ve tebliğlerin yarıdan fazlasının Türkiye dışından katılımcılar tarafından sunulması esastır." değişikliğine uygun düzenlenmiştir.

Bilgilerinize arz edilir,  
Saygılarımla

A large, faint watermark logo in the background of the page. It features a central image of two hands shaking over a globe, surrounded by the text "ATLAS INTERNATIONAL JOURNAL ON SOCIAL SCIENCES" and "2015". Below the handshake, the website "www.atlasjournal.net" is visible. The logo is circular and has a purple and blue color scheme.  
Prof. Dr. Natalya LATIGINA  
Organizing Board Committee

**Web site:** <https://www.atlasconference.org/>  
**Email adres:** [atlaskongre@gmail.com](mailto:atlaskongre@gmail.com)

